

A41

TM 9-759

WAR DEPARTMENT TECHNICAL MANUAL

TANK, MEDIUM M4A3

WAR DEPARTMENT • SEPTEMBER 1944

WAR DEPARTMENT TECHNICAL MANUAL

TM 9-759

This manual supersedes TM 9-759, dated 18 February 1943; OFSTB 759-5, dated 11 September 1943, reprinted as TB ORD 43; OFSTB 759-6, dated 14 September 1943; OFSTB 759-7, dated 12 October 1943; OSTB 759-8, dated 4 November 1943; OFSTB 759-9, dated 24 November 1943; WDTB 9-759-10, dated 29 February 1944. This manual also supersedes pertinent information in OFSTB 700-1, dated 1 January 1942; OFSTB 700-14, dated 17 June 1942; OFSTB 700-15, dated 21 July 1942; OFSTB 700-48, dated 22 April 1943; OFSTB 700-49, dated 22 April 1943, reprinted as TB ORD 158; OFSTB 700-57, dated 22 May 1943; OFSTB 700-59, dated 8 June 1943; OFSTB 700-66, dated 11 June 1943; OFSTB 700-67, dated 15 June 1943; OFSTB 700-70, dated 21 June 1943; OFSTB 700-72, dated 24 June 1943; OFSTB 700-91, dated 11 August 1943; OFSTB 700-98, dated 1 October 1943; WDTB ORD 11, dated 13 January 1944; WDTB ORD 12, dated 12 January 1944; WDTB ORD 19, dated 24 January 1944; WDTB ORD 20, dated 24 January 1944; WDTB ORD 30, dated 3 February 1944; WDTB ORD 41, dated 12 February 1944; WDTB ORD 83, dated 25 April 1944; WDTB ORD 88, dated 4 May 1944; WDTB ORD 90, dated 13 May 1944; WDTB ORD 95, dated 22 May 1944; WDTB ORD 96, dated 22 May 1944; WDTB ORD 116, dated 28 June 1944; WDTB ORD 125, dated 22 July 1944; WDTB ORD 126, dated 19 July 1944; WDTB ORD 131, dated 2 August 1944.

TANK, MEDIUM M4A3



WAR DEPARTMENT

• SEPTEMBER 1944

*United States Government Printing Office
Washington : 1948*

WAR DEPARTMENT
Washington 25, D. C., 15 September 1944

TM 9-759, Tank, Medium, M4A3, is published for the information and guidance of all concerned.

[A.G. 300.7 (6 Jan 44)
O.O.M. 461/Rar. Ars. (18 Sep 44)]

BY ORDER OF THE SECRETARY OF WAR:

G. C. MARSHALL,
Chief of Staff.

OFFICIAL:

J. A. ULIO,
Major General,
The Adjutant General.

DISTRIBUTION: D 17 (10); IR 9 (4); 17 (2); IBn 9 (2), 17 (4)
IC 9 (5), 17 (1).

(For explanation of symbols, see FM 21-6.)

CONTENTS—Contd.

		Paragraphs	Pages
SECTION	XXIV. Vertical volute spring, suspension and tracks	132-137	328-345
	XXV. Hull and turret	138-146	345-349
	XXVI. Turret traversing mechanism	147-151	350-359
	XXVII. Radio interference suppression	152-158	359-366
PART FOUR—AUXILIARY EQUIPMENT			
A—AUXILIARY GENERATOR, FIXED FIRE EXTINGUISHER SYSTEM, COMMUNICATION EQUIPMENT			
SECTION	XXVIII. Auxiliary generator	159-160	367-369
	XXIX. Fixed fire extinguisher system	161	369-372
	XXX. Communication equipment	162-164	372-379
B—ARMAMENT—75-MM GUN M3 IN THE COMBINATION GUN MOUNTS M34 AND M34A1			
SECTION	XXXI. Introduction	165-167	380-381
	XXXII. Operating instructions	168-176	381-392
	XXXIII. Sighting and fire control equipment	177-181	392-395
	XXXIV. Ammunition	182-183	395-398
C—ARMAMENT—76-MM GUN M1A1, M1A1C, OR M1A2 IN THE COMBINATION GUN MOUNT M62			
SECTION	XXXV. Introduction	184-186	398-403
	XXXVI. Operating instructions	187-195	403-417
	XXXVII. Sighting and fire control equipment	196-202	417-426
	XXXVIII. Ammunition	203-204	426-428
D—ARMAMENT—105-MM HOWITZER M4 IN THE COMBINATION GUN MOUNT M52			
SECTION	XXXIX. Introduction	205-206	428-432
	XL. Operating instructions	207-214	432-441
	XLI. Sighting and fire control equipment	215-219	441-443
	XLII. Ammunition	220-221	443-447
APPENDIX			
	XLIII. Shipment and Limited Storage	222-224	448-451
	XLIV. References	225-227	452-457
			458-472

CONTENTS—Contd.

	Paragraphs	Pages
SECTION XXIV. Vertical volute spring, suspension and tracks	132-137	328-345
XXV. Hull and turret	138-146	345-349
XXVI. Turret traversing mechanism	147-151	350-359
XXVII. Radio interference suppression	152-158	359-366
PART FOUR—AUXILIARY EQUIPMENT		
A—AUXILIARY GENERATOR, FIXED FIRE EXTINGUISHER SYSTEM, COMMUNICATION EQUIPMENT		
SECTION XXVIII. Auxiliary generator	159-160	367-369
XXIX. Fixed fire extinguisher system	161	369-372
XXX. Communication equipment	162-164	372-379
B—ARMAMENT—75-MM GUN M3 IN THE COMBINATION GUN MOUNTS M34 AND M34A1		
SECTION XXXI. Introduction	165-167	380-381
XXXII. Operating instructions	168-176	381-392
XXXIII. Sighting and fire control equipment	177-181	392-399
XXXIV. Ammunition	182-183	395-398
C—ARMAMENT—76-MM GUN M1A1, M1A1C, OR M1A2 IN THE COMBINATION GUN MOUNT M62		
SECTION XXXV. Introduction	184-186	398-403
XXXVI. Operating instructions	187-195	403-417
XXXVII. Sighting and fire control equipment	196-202	417-426
XXXVIII. Ammunition	203-204	426-428
D—ARMAMENT—105-MM HOWITZER M4 IN THE COMBINATION GUN MOUNT M52		
SECTION XXXIX. Introduction	205-206	428-432
XL. Operating instructions	207-214	432-441
XLI. Sighting and fire control equipment	215-219	441-443
XLII. Ammunition	220-221	443-447
APPENDIX		
XLIII. Shipment and Limited Storage	222-224	448-451
XLIV. References	225-227	452-457
INDEX		458-477

This manual supersedes TM 9-759, dated 18 February 1943; OFSTB 759-5, dated 11 September 1943, reprinted as TB ORD 43; OFSTB 759-6, dated 14 September 1943; OFSTB 759-7, dated 12 October 1943; OFSTB 759-8, dated 4 November 1943; OFSTB 759-9, dated 24 November 1943; WDTB 9-759-10, dated 29 February 1944. This manual also supersedes pertinent information in OFSTB 700-1, dated 1 January 1942; OFSTB 700-14, dated 17 June 1942; OFSTB 700-15, dated 21 July 1942; OFSTB 700-48, dated 22 April 1943; OFSTB 700-49, dated 22 April 1943, reprinted as TB ORD 158; OFSTB 700-57, dated 22 May 1943; OFSTB 700-59, dated 8 June 1943; OFSTB 700-66, dated 11 June 1943; OFSTB 700-67, dated 15 June 1943; OFSTB 700-70, dated 21 June 1943; OFSTB 700-72, dated 24 June 1943; OFSTB 700-91, dated 11 August 1943; OFSTB 700-98, dated 1 October 1943; WDTB ORD 11, dated 13 January 1944; WDTB ORD 12, dated 12 January 1944; WDTB ORD 19, dated 24 January 1944; WDTB ORD 20, dated 24 January 1944; WDTB ORD 30, dated 3 February 1944; WDTB ORD 41, dated 12 February 1944; WDTB ORD 83, dated 25 April 1944; WDTB ORD 88, dated 4 May 1944; WDTB ORD 90, dated 13 May 1944; WDTB ORD 95, dated 22 May 1944; WDTB ORD 96, dated 22 May 1944; WDTB ORD 116, dated 28 June 1944; WDTB ORD 125, dated 22 July 1944; WDTB ORD 126, dated 19 July 1944; WDTB ORD 131, dated 2 August 1944.

PART ONE—INTRODUCTION

Section I

GENERAL

1. SCOPE.

a. These instructions are published for the information and guidance of the personnel to whom this equipment is assigned. They contain information on the operation and maintenance of the Medium Tank M4A3, as well as descriptions of the major units and their functions in relation to the other components of this vehicle.

b. This manual has the following arrangement:

(1) Part One—General, contains description and data. It lists the tools, spare parts, and equipment carried on the vehicle, and also organizational special tools for this vehicle.

(2) Part Two—Operating Instructions, contains instructions for the operation of the vehicle, with description and location of the controls and instruments.

(3) Part Three—Maintenance Instructions, contains information needed for the performance of the scheduled lubrication and preventive maintenance services, and instructions for maintenance operations which are the responsibility of the using organizations (first and second echelons). Stock numbers in this part were obtained from Ordnance Supply Catalog ORD 7-8-9, SNL G-104, Volume 15, SNL G-205 dated 1 June 1944.

(4) Part Four covers the auxiliary equipment mounted on this vehicle. Detailed instructions pertaining to this auxiliary equipment are contained in separate technical manuals (see section XLV for references).

(a) Part Four-A identifies the auxiliary generator, fixed fire extinguisher, and communications equipment, and contains the information necessary to connect this equipment for use or transportation, and to protect it properly.

TANK, MEDIUM, M4A3

(b) Part Four-B contains the essential instructions for the operation of the 75-mm gun M3 in the combination gun mounts M34 and M34A1. It lists the authorized ammunition and sighting equipment for the 75-mm gun.

(c) Part Four-C contains the essential instructions for the operation of the 76-mm gun M1A1, M1A1C, or M1A2 in the combination gun mount M62. It lists the authorized ammunition and sighting equipment for the 76-mm gun.

(d) Part Four-D contains the essential instructions for the operation of the 105-mm howitzer M4 in the combination gun mount M52. It lists the authorized ammunition and sighting equipment for the 105-mm howitzer.

(5) The appendix contains instructions for shipment and limited storage, and a list of references including standard nomenclature lists, technical manuals, and other publications applicable to the vehicle.

2. RECORDS.

a. Forms and records applicable for use in performing prescribed operations are listed below with brief explanations of each.

(1) **STANDARD FORM NO. 26, DRIVER'S REPORT—ACCIDENT, MOTOR TRANSPORTATION.** One copy of this form will be kept with the vehicle at all times. In case of accident resulting in injury or property damage, it will be filled out by the driver on the spot, or as promptly as practical thereafter.

(2) **WAR DEPARTMENT FORM NO. 48, DRIVER'S TRIP TICKET AND PREVENTIVE MAINTENANCE SERVICE RECORD.** This form, properly executed, will be furnished to the driver when his vehicle is dispatched on nontactical missions. The driver and the official user of the vehicle will complete in detail approximate parts of this form. These forms need not be issued for vehicles in convoy or on tactical missions. The reverse side of this form contains the driver's daily and weekly preventive maintenance service reminder schedule.

(3) **W.D., A.G.O. FORM NO. 478, MWO AND MAJOR UNIT ASSEMBLY REPLACEMENT RECORD.** This form will be used by all personnel completing a modification or major unit assembly (engine, transmission, transfer case, and tracks) replacement to record clearly the description of work completed, date, vehicle hours, and/or mileage, and MWO number or nomenclature of unit assembly. Personnel performing the operation will initial in the column provided. Minor repairs, parts, and accessory replacements will not be recorded.

(4) **W.D., A.G.O. FORM NO. 6, DUTY ROSTER.** This form, slightly modified, will be used for scheduling and maintaining a record of vehicle maintenance operations. It may be used for lubrication records.

GENERAL

RA PD 329216

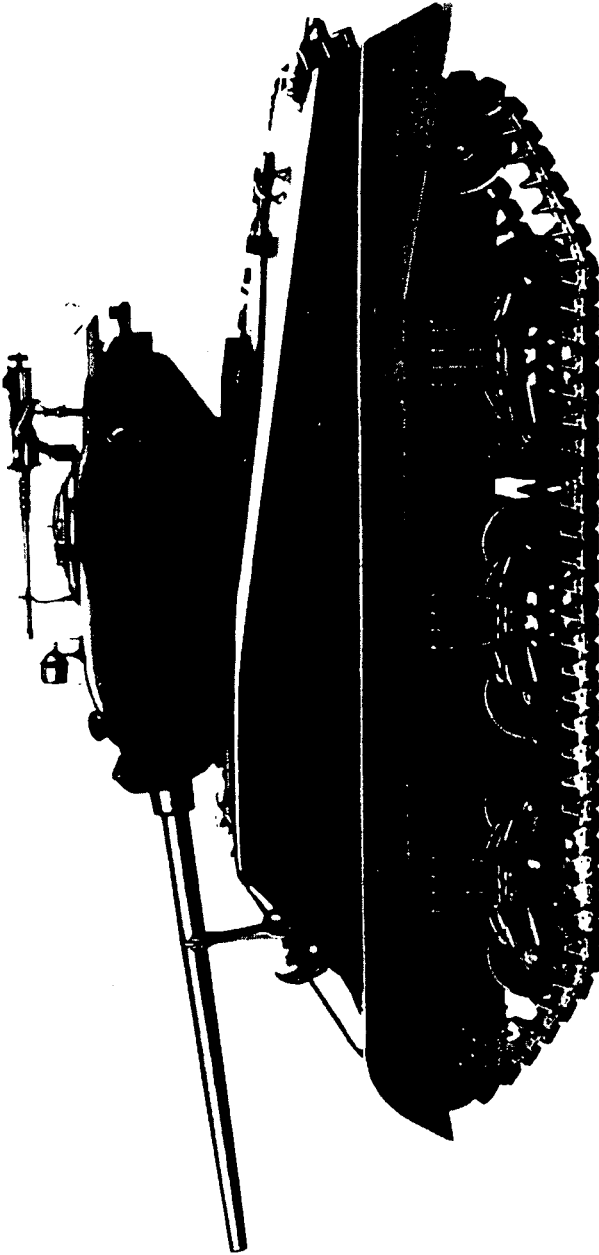

Figure 1—Left Side View of Medium Tank M4A3 (76-mm Vehicles)

TANK, MEDIUM, M4A3

(5) W.D., A.G.O. FORM NO. 462, PREVENTIVE MAINTENANCE SERVICE AND TECHNICAL INSPECTION WORK SHEET FOR FULL-TRACK AND TANK-LIKE WHEELED VEHICLES. This form will be used for 50-hour (500-mile) or 100-hour (1,000-mile) services, and for technical inspections of these vehicles.

(6) W.D., O.O. FORM NO. 7353, SPOT-CHECK INSPECTION REPORT FOR ALL MOTOR VEHICLES. This form may be used by all commanding officers or their staff representatives in making spot-check inspections on all vehicles.

(7) W.D., A.G.O. FORM NO. 468, UNSATISFACTORY EQUIPMENT RECORD. This form will be used for reporting manufacturing, design, or operational defects in materiel with a view to improving and correcting such defects, and for use in recommending modifications of materiel. This form will not be used for reporting failures, isolated materiel defects, or malfunctions of materiel resulting from fair wear and tear or accidental damage, nor for the replacement, repair, or the issue of parts and equipment. It does not replace currently authorized operational or performance records.

(8) W.D., O.O. FORM NO. 7370, EXCHANGE PART OR UNIT IDENTIFICATION TAG. This tag, properly executed, may be used when exchanging unserviceable items for like serviceable assemblies, parts, vehicles, and tools.

Section II**DESCRIPTION AND DATA****3. DESCRIPTION.**

a. The Medium Tank M4A3 is an armored, full-track laying vehicle, powered by a 500-horsepower Ford tank engine which is an 8-cylinder, liquid-cooled, V-type engine designed specifically for tanks. The engine is located in the rear of the hull. The operator steers the vehicle by means of two levers, located in the front end of the hull. The vehicle has five forward speeds and one reverse, and is wired for radio installation, and for an interphone system within the tank. The turret can be rotated through 360 degrees. An auxiliary electrical generating system, consisting of a generating set powered by a 1-cylinder, 2-cycle gasoline engine, is used to charge the batteries when the main generator is not operating, or when the use of electrical units in the vehicle draws large amounts of current.

4. DIFFERENCES AMONG MODELS.

a. M4A3 Tank (76-mm) (fig. 2). The M4A3 tank with a 76-mm gun is provided with 76-mm ammunition racks which have liquid filled containers on either side to prevent fire in case the side of t

DESCRIPTION AND DATA

RA PD 329372

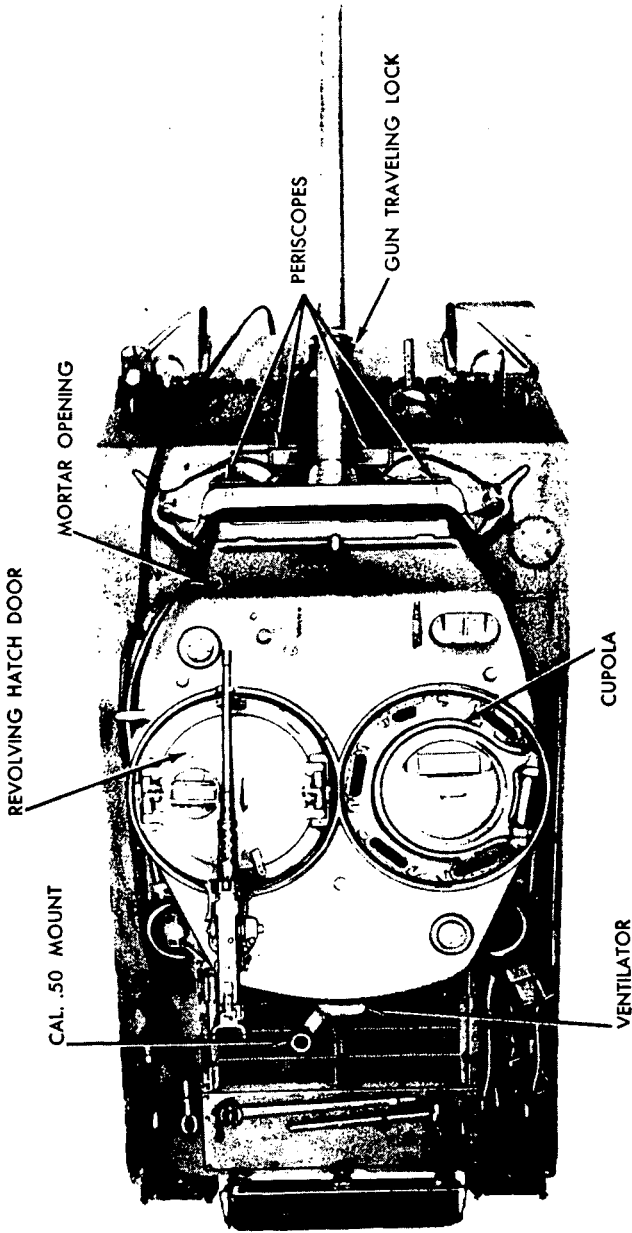
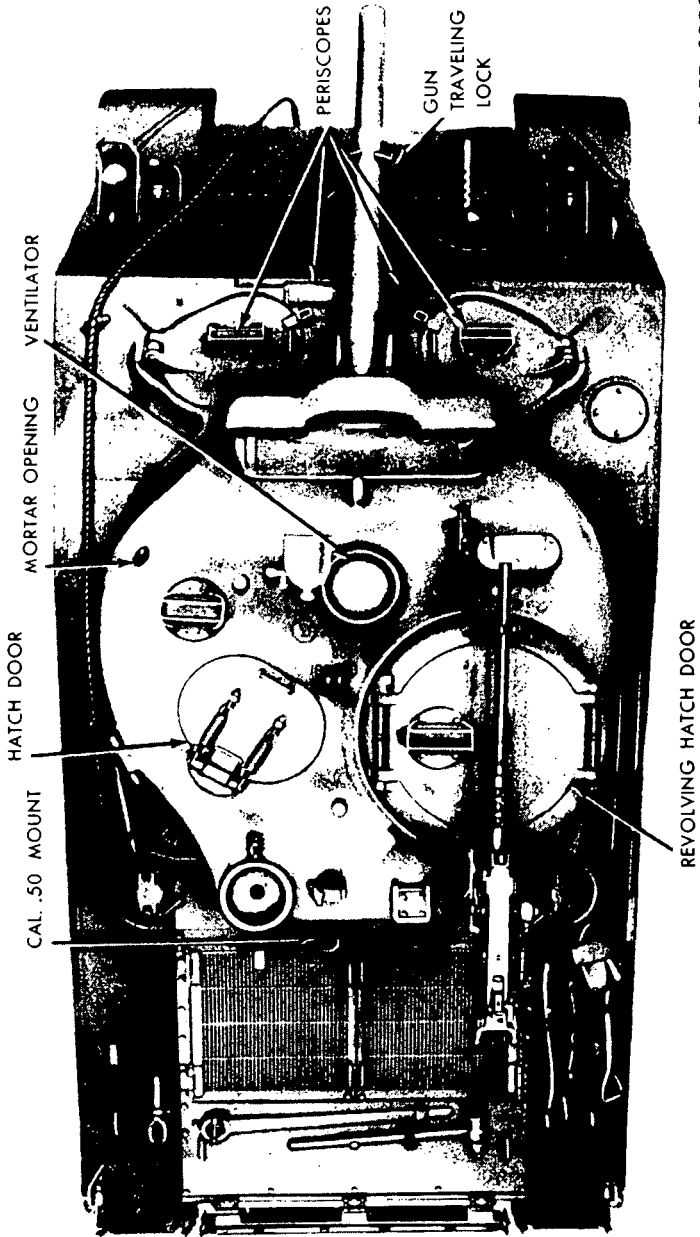

Figure 2—Top View of Medium Tank M4A3 (76-mm Vehicles)

TANK, MEDIUM, M4A3



RA PD 329373

Figure 3—Top View of Medium Tank M4A3 (75-mm Wet Storage Vehicles)

DESCRIPTION AND DATA

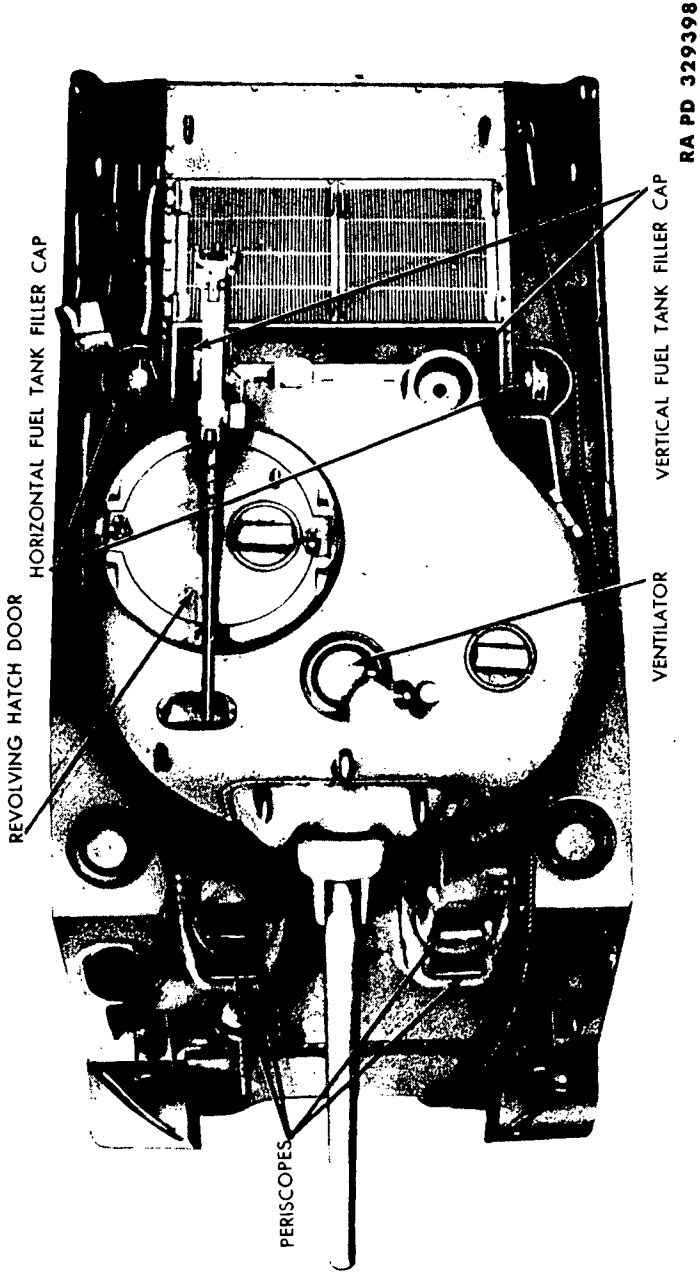
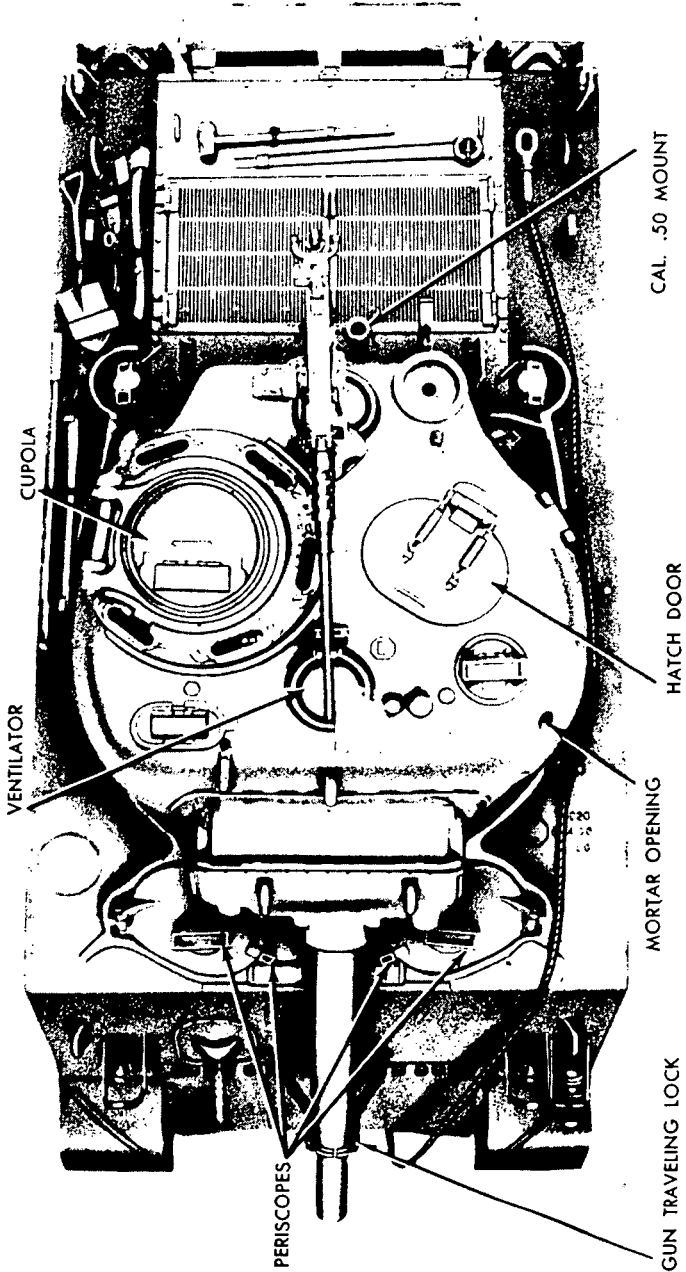

Figure 4—Top View of Medium Tank M4A3 (75-mm Dry Stowage Vehicles)

TANK, MEDIUM, M4A3



RA PD 329405

Figure 5—Top View of Medium Tank M4A3 (105mm Howitzer Vehicles)

DESCRIPTION AND DATA

Vehicle is pierced. This is referred to as wet stowage. This vehicle is equipped with a different style turret than the other M4A3 tanks (fig. 16). The turret is larger, and has only a partial platform for the gunner and commander. The loader stands on a subfloor, which extends across the lower hull level with the sponson.

b. **M4A3 Tank (75-mm Wet Stowage Vehicles)** (fig. 3). The M4A3 tank with wet stowage and a 75-mm gun has a full turret floor which is bracket-mounted to the turret.

c. **M4A3 Tank (75-mm Dry Stowage Vehicles)** (fig. 4). The M4A3 tank, with dry stowage and a 75-mm gun, has a basket and floor that is attached to the turret (fig. 17). Some dry stowage vehicle turrets, however, are identical to the turret in the M4A3 wet stowage vehicles. Engine compartment door shutters or a gun traveling lock are not provided for the early M4A3 dry stowage vehicle.

d. **M4A3 Tank (105-mm Howitzer Vehicles)** (fig. 5). The M4A3 tank with the 105-mm Howitzer is identical to the M4A3 tank with wet stowage and 76-mm gun, with the exception of the gun and turret. The 105-mm gun has a larger bore, and the barrel is considerably shorter than the 76-mm gun. The turret on the 105-mm howitzer vehicle is smaller than the one on the 76-mm gun vehicle, and can be rotated manually only (fig. 19).

5. DATA.

a. Vehicle Specifications.

Length, over-all (with sand shield)	20 ft 7 in.
(76-mm including gun)	24 ft 8 in.
Width, over-all (with sand shield)	8 ft 9 in.
Height, over top of A.A. gun pintle stand:	
76-mm	134 ⁷ / ₈ in.
75-mm	132 ⁷ / ₈ in.
105-mm	132 ⁷ / ₈ in.
Tread (center to center)	83 in.
Crew	5 men
Weight of vehicle—empty (approximate):	
75-mm	63,097 lb
76-mm	65,127 lb
105-mm	63,357 lb
Weight of vehicle—loaded (approximate):	
75-mm	69,565 lb
76-mm	71,175 lb
105-mm	69,915 lb

TANK, MEDIUM, M4A3

Ground pressure:

23 in. wide track 10.3 psi

16⁹/₁₆ in. wide track 14.3 psi

Ground contact area:

16⁹/₁₆ in. wide track 4,870 sq in.

23 in. wide track 6,760 sq in.

Ground clearance 17¹/₈ in.

Octane rating of gasoline 80

Approach angle 38 deg

Departure angle 25 deg

Engine (Ford tank engine) model GAA

Net horsepower 500 at 2,600 rpm

Number of cylinders (60-deg V) 8

Weight of engine with accessories 2,350 lb

Weight of engine without accessories 1,470 lb

Net torque foot pounds 950 at 2,100 rpm

b. Performance.

Maximum sustained speed on hard road 26 mph

Expected cross-country speeds for various
terrains 4 to 26 mph

Maximum allowable engine speed—no load 2,800 rpm

Minimum engine idling speed 500 rpm

Maximum grade ascending ability 60 pct

Maximum grade descending ability 60 pct

Maximum width of ditch tank will cross 90 in.

Maximum vertical obstacle, such as wall, that the
tank will climb over 24 in.

Maximum fording depth (at slowest forward speed) 36 in.

Number of miles without refueling (approximate) 100

Oil consumption (approximate) 50 mi per gal

c. Capacities.

Fuel capacity 168 gal

Power train capacity 164 qt

Cooling system capacity 14 gal

Crankcase capacity 32 qt

d. Communications.

SCR-508, SCR-528 or SCR-538 (FM) sending and receiving. SCR-506 sending and receiving (command tanks only).

Five-place interphone system part of all above radio sets.

Section III

* VEHICLE STOWAGE AND SPECIAL TOOLS

6. VEHICLE TOOLS.

a. Pioneer Tools.

Tool	Number Carried	Where Carried
AX, chopping, 4 lb	1	Rear deck
BAR, crow, pinch point, 5 ft long	1	Rear deck
CUTTERS, wire	1	In tool box
HANDLE, mattock	1	Rear deck
MATTOCK, pick, M1 (without handle)	1	Rear deck
SHOVEL, short-handled	1	Rear deck
SLEDGE, blacksmith, double face, 10 lb	1	Rear deck

b. Vehicular Tools.

BAR, cross	1	In bag, tool D71860
CHISEL, cold, 3/4-in.	1	In bag, tool D71860
EXTENSION, handy grip, 1/2-in. sq drive, 5 in. long	1	In bag, tool D71860
EXTENSION, 1/2-in. sq drive, 10 in. long	1	In bag, tool D71860
FILE, hand, smooth, 8 in.	1	In bag, tool D71860
FILE, 3-sq smooth, 6 in.	1	In bag, tool D71860
FIXTURE, set, track connecting and connector pulling	1	Right rear compartment floor
HAMMER, machinist's, ball peen, 32 oz	1	In bag, tool D71860
HANDLE, combination tee, 1/2-in. sq drive, 11 in. long	1	In bag, tool D71860
HANDLE, combination tee, 3/4-in. sq drive, 17 in. long	1	In bag, tool D71860
HANDLE, flexible, 1/2-in. sq drive, 12 in. long	1	In bag, tool D71860
HANDLE, speeder, 1/2-in. sq drive, 17 in. long	1	In bag, tool D71860
JOINT, universal, 1/2-in. sq drive	1	In bag, tool D71860
OILER, trigger-type, 1 pt	1	In bracket on floor by assistant driver
PLIERS, combination, slip joint, 8 in.	1	In bag, tool D71860
PLIERS, side-cutting, 8 in.	1	In bag, tool D71860
RATCHET, reversible, 1/2 sq drive, 9 in.	1	In bag, tool D71860

*The lists in this section are for information only. They are not to be used as a basis for requisition.

TM 9-759

6

TANK, MEDIUM, M4A3

Tool	Number Carried	Where Carried
SCREWDRIVER, machinist's, 5-in. blade	1	In bag, tool D71860
SCREWDRIVER, special purpose, 1½-in. blade	1	In bag, tool D71860
SCREWDRIVER, special purpose, 1¾-in. blade	1	In bag, tool D71860
WRENCH, adjustable, single end, 8 in. long	1	In bag, tool D71860
WRENCH, adjustable, single end, 12 in. long	1	In bag, tool D71860
WRENCH, engineer's dble hd alloy steel, 5/16 x 3/8 in.	1	In bag, tool D71860
WRENCH, engineer's, dble hd alloy steel, 7/16 x 1/2 in.	1	In bag, tool D71860
WRENCH, engineer's, dble hd alloy steel, 9/16 x 1 1/16 in.	1	In bag, tool D71860
WRENCH, engineer's, dble hd alloy steel, 5/8 x 3/4 in.	1	In bag, tool D71860
WRENCH, engineer's, dble hd alloy steel, 1 3/16 x 7/8 in.	1	In bag, tool D71860
WRENCH, engineer's, dble hd alloy steel, 1 5/16 x 1 in.	1	In bag, tool D71860
WRENCH, plug 9/16-in. hex (for transmission and oil drain plug)	1	In bag, tool D71860
WRENCH, plug, 3/4-in. hex (for differential filler and drain plug)	1	In bag, tool D71860
WRENCH, safety screw, 3/32-in. hex	1	In bag, tool D71860
WRENCH, safety screw, 1/8-in. hex	1	In bag, tool D71860
WRENCH, safety screw, 3/16-in. hex	1	In bag, tool D71860
WRENCH, safety screw, 1/4-in. hex	1	In bag, tool D71860
WRENCH, safety screw, 5/16-in. hex	1	In bag, tool D71860
WRENCH, safety screw, 3/8-in. hex	1	In bag, tool D71860
WRENCH, safety screw, 5/8-in. hex	1	In bag, tool D71860
WRENCH, socket, 1/2-in. sq drive, 3/8 in. sq	1	In bag, tool D71860
WRENCH, socket, 1/2-in. sq drive, 7/16-in. hex	1	In bag, tool D71860
WRENCH, socket, 1/2-in. sq drive, 1/2-in. hex		In bag, tool D71860
WRENCH, socket, 1/2-in. sq drive, 9/16-in. hex	1	In bag, tool D71860
WRENCH, socket, 1/2-in. sq drive, 5/8-in. hex		In bag, tool D71860

VEHICLE STORAGE AND SPECIAL TOOLS

Item	Number Carried	Where Carried
WRENCH, socket, 1/2-in. sq drive, 3/4-in. hex.....	1	In bag, tool D71860
WRENCH, socket, 1/2-in. sq drive, 7/8-in. hex.....	2	In bag, tool D71860
WRENCH, socket, 1/2-in. sq drive, 1 5/16-in. hex.....	2	In bag, tool D71860
WRENCH, socket, 1/2-in. sq drive, 1-in. hex.....	1	In bag, tool D71860
WRENCH, socket, 1/2-in. sq drive, 1 1/4-in. hex.....	1	In bag, tool D71860
WRENCH, socket, 1/2-in. sq. drive, 1 1/8-in. hex.....	1	In bag, tool D71860
WRENCH, socket, 3/4-in. sq. drive, 1 1/2-in. hex.....	1	In bag, tool D71860
WRENCH, track-adjusting.....	1	On rear deck of tank in bracket

7. VEHICLE EQUIPMENT AND SPARE PARTS.

a. Communication Equipment.

Item	Number Carried	Where Carried
ANTENNA, complete with cover (SCD1241).....	1	Blanket roll rack, rear of tank
Consists of:		
Mast section MS49.....	1	
Mast section MS50.....	1	
Mast section MS51.....	1	
Mast section MS52.....	1	
Mast section MS53.....	1	
FLAG set, M238.....	1	In turret bracket, right side
Composed of:		
Case CS-90.....	1	Mounted in channel
Flag, MC-273 (red).....	1	Mounted in channel
Flag, MC-274 (orange).....	1	Mounted in channel
Flag, MC-275 (green).....	1	Mounted in channel
Flagstaff, MC-270.....	3	
FLARES.....	12	In box—mounted on battery box
White star, parachute, flare, M17.....	3	
White star, cluster, flare, M18.....	3	
Green star, parachute, flare, M19.....	3	
Amber star, parachute, flare, M21.....	3	

TM 9-759

7.

TANK, MEDIUM, M4A3

Item	Number Carried	Where Carried
PANEL set	1	In blanket roll rack, rear of tank
Consists of:		
Cases CS 150	2	
Panel AL 140	1	
Panel AL 141	1	
PROJECTOR, ground signal, M4	1	In flare box
RADIO set, SCR-506	1	
RADIO set, either SCR-508, SCR-528, or SCR-538	1	
b. Fire Fighting Equipment.		
EXTINGUISHER, fire, 4 lb CO ₂	2	1 right side transmission in front hull, 1 rear of turret basket
c. Rations.		
TYPE "K," 2 days' rations for 5 men OR	30 boxes	} Ration box, right rear sponson
TYPE "C," 2 days' rations for 5 men	60 cans	
TYPE "D," 1 days' rations for 5 men	2 boxes	
d. Sighting Equipment.		
BINOCULAR, M13, complete	1	In bracket in turret right wall
Consists of:		
Binocular, M13	1	
Case, carrying M17	1	
BLOCK, direct vision	2	In box in turret to right of radio
BULB, lamp (for elevation quadrant and azimuth indicator)	10	In box C101039 behind driver
CASE, carrying, gunner's quadrant, M1	1	In bracket in right sponson over 5-gal. water can
HEAD (for periscope, M4A1 and M6) (spare)	15	6 in bracket hood hatch holder 3 in each periscope box
HEADREST	1	On gun mount
HOLDER, periscope	1	In periscope box in turret

VEHICLE STOWAGE AND SPECIAL TOOLS

Item	Number Carried	Where Carried
LAMP, electric (for telescope reticle lights)	2	In box C101039 behind driver
LIGHT, instrument, M32 or M39C (for telescope M70F)	1	In clip on gun mount
LIGHT, instrument, M30 (for elev. quadrant periscope M4A1)	1	In clip on gun mount
MOUNT, telescope, M57	1	On gun mount
PERISCOPE, M4A1 (w telescope, M38A2) (spare)	1	In gunner's sighting device D50897
PERISCOPE, M4A1 (w telescope, 38A2) (spare)	1	In box to right of gunner's seat on turret floor
PERISCOPE, M6	6	Mounted in position
PERISCOPE, M6 (spare)	6	4 in hood hatch holder, 2 in turret
QUADRANT, elevation, M9	1	On gun mount
QUADRANT, gunner's, M1	1	In box in right sponson over water can
TELESCOPE, M70F	1	In telescope mount
e. General Equipment.		
ADAPTER, extension, hose, type, lubricating	1	Stowed with lubricating gun
APPARATUS, decontaminating, 1½ qt M2	2	In box D82339
BAG, canvas, field O.D., M1936	5	Right front sponson
BAG (for arm spotlight C100212)	1	On spotlight
BAG, tool	1	Behind driver's seat
BATTERY (6 to be put in flashlight) (6 to be put in instr. lights) (12 spares)	24	In box, C101039
BELT, safety	5	
BOX, flare	1	On side of battery box in hull
BUCKET, canvas folding, 18-qt	1	Right sponson
CABLE, towing, 1½-in. x 20 ft	1	Over left side of vehicle, outside
CANTEEN, M1910, with cup and cover M1910	5	3 mounted on turret, and 2 in hull front

TM 9-759

7

TANK, MEDIUM, M4A3

Item	Number Carried	Where Carried
CATALOG, service parts SNL-G-104	1	Manual compartment
CONTAINER, water, 5-gal (QMC Standard A353)	3	Right sponson
CRANK (for tanks with Wright R975 engine)	1	On outside and rear end of tank
FLASHLIGHT, TL-122 (spec. 17-197)	3	In turret on wall, 1 by commander 1 by gunner 1 by loader
GROUSER (when track D48076 or D48067 is used)	26	In grouser compartment in rear of tank
GUN, lubricating, pressure (hand-operated)	1	Right rear lower hull
HOOD, hatch	1	In bracket between driver and ass't
INSTRUCTION sheet for compass	1	Manual compartment
KIT, first-aid (24-unit) (spec. 1553)	1	Right front sponson
KIT, accessories, Homelite	1	In tool box right front sponson
Consists of:		
Plug, spark	3	
Rope and grip, starting	1	
Screwdriver	1	
Socket, spark plug	1	
Wrench, double-end	1	
LAMP, inspection	1	In lamp, inspection, B209297A
LAMP, inspection	1	In tool box
LAMP (spare for flashlight)	1	In box C101039 behind driver
LIST, organizational spare parts and equipment, SNL G-104	1	Manual box, right rear sponson
MANUAL, field, for cal. .30 MG M1919A4, FM 23-50	1	Manual box, right rear sponson
MANUAL, field, for cal. .50 MG M2, FM 23-65	1	Manual box, right rear sponson

9-759

7-8

TANK, MEDIUM, M4A3

Item	Number Carried	Where Carried
TUBE, flexible, nozzle	2	Right rear sponson next to manual box
WAR DEPT. Lub. Order No. 58A for comb. gun mount M34	1	In bracket in hull
WAR DEPT. Lub. Order No. 104 for M4A3	1	In bracket in hull
WIRE, soft iron, 14 ga, 10 ft	1	Tool bag behind driver's seat

f. Vehicle Spare Parts.

BULB, lamp, 3 cp 24-28V	4	In tool box—right front sponson
CONNECTION, end (furnish in accordance with track)	12	Right rear tool box in hull
PLUG, lubrication, straight $\frac{1}{8}$ in.	3	Stowed with lubricating gun
PLUG, relief— $\frac{1}{8}$ -in. 27 N.P.T.	3	Stowed with lubricating gun
NUT, safety, $\frac{5}{8}$ -18 NF-3 (furnish in accordance with track)	16	Right rear tool box in hull
PIN (used with 23-in., T55 track)	6	In right rear tool box in hull
PIN (used with 23-in., T63 track)	24	In right rear tool box in hull
SHOE assembly (furnish with wide track only)	6	3 mounted in left rear side 3 mounted right rear side
TRACK (shoe) assembly (to match track furnished)	6	In brackets on rear of tank
WEDGE (furnish in accordance with track being used)	12	Right rear tool box on hull

GUN TOOLS.

a. 75-mm Gun.

EYE bolt, breechblock removing	1	Spare parts box
ROD, push (for shaft B163351)	1	Spare parts box

VEHICLE STOWAGE AND SPECIAL TOOLS

Item	Number Carried	Where Carried
MANUAL, technical (for Homelite generator)), TM 9-1731K	1	Manual box, right rear sponson
MANUAL, technical (for hydraulic traverse (Oilgear)), TM 9-1727K	1	Manual box, right rear sponson
MANUAL, technical (for Gyro-stabilizer)	1	Manual box, right rear sponson
MANUAL, (technical for 76-mm gun M1)	1	Manual box, right rear sponson
MANUAL, technical (for operator), TM 9-759, (Med. Tk. M4A3 only)	1	Manual box, right rear sponson
MITTENS, asbestos, prs	2	On oddment tray, in turret
NET, camouflage, cotton, shrimp, 45-ft x 45-ft (spec. T-1669)	1	In bracket on rear of turret
OIL, engine (spec. 2-104) (in container 1-qt, type 1, class D, spec. 100-13)	8	Right rear tool box
OIL, hydraulic (spec. 2-79) (in container 1-qt, type 1, Class D, spec. 100-13)	1	Right rear tool box
PADLOCK, 1½-in., 2 keys	1	In turret
PAULIN, 12 ft x 12 ft	1	In bracket on rear of tank
ROLL, blanket	5	In bracket on rear of tank
STOVE, cooking, gasoline M1941, 1 burner	1	Right rear sponson with rations
Consists of:		
Coleman military burner No. 520 with accessory cups, 8½ in. high 4 ⁷ / ₁₆ in. dia.		
TAPE, adhesive, olive drab, 4 in. wide x 15 yd long (spec. AXS-871)	1	Tool box, right front sponson
TAPE, friction, ¾ in. wide, 30-ft roll	1	Tool box, right hull

VEHICLE STOWAGE AND SPECIAL TOOLS

b. Caliber .30 Machine Gun M1919A4.

Item	Number Carried	Where Carried
SCREWDRIVER, common, 3-in. blade	2	Spare parts box
WRENCH, combination, M6	2	Spare parts box
WRENCH, socket, front barrel bearing plug	1	Spare parts box

c. Caliber .50 Machine Gun M2.

WRENCH, combination, M2	1	Spare parts box
-------------------------	---	-----------------

9. GUN EQUIPMENT.

a. 75-mm Gun.

(1) AMMUNITION.

75-MM rounds	104	4 rounds in box on basket floor 100 rounds in vertical racks on hull floor
--------------	-----	---

(2) EQUIPMENT.

HOOK, Arty. gun, O.O. Form 5825	1	Manual box, right rear sponson
BRUSH, bore, M10, w/staff		In tool box, right front sponson

Consists of:

Brush, bore, M10, B168024	1	
Staff, end, B197239	1	Under blanket roll carrier on rear of tank
Staff, middle, B197240	1	Under blanket roll carrier on rear of tank
Staff, middle, B164039	1	
COVER, bore brush, M516	1	On bore brush
COVER, breech	1	On gun
COVER, muzzle	1	On gun
EXTRACTOR, shell	1	Behind driver's seat
GUN, lubricating oil (2 oz)	1	Spare parts box
HOSE, assembly	1	With gun lub. oil
OIL, recoil, special (spec. AXS-808) (in container 1-qt, type 1, class D, spec. 100-13)	1	In tool box, right rear lower hull
HAMMER, cleaning and unloading, M4	1	In spare parts box

TM 9-759

9

TANK, MEDIUM, M4A3

Item	Number Carried	Where Carried
ROLL, spare parts, M13 (w/o contents)	1	In spare parts box
SETTER, fuze, M14	1	In spare parts box
SIGHT, bore, complete muzzle- RF11CD, breech-RF11HA	1	Tool box, right rear lower hull
TABLE, firing	1	
TARGET, testing (set of 4)	1	Tool box, right rear lower hull
WRENCH, fuze, M7	1	Tool box, right rear lower hull

b. Caliber .30 Machine Gun M1919A4.

(1) AMMUNITION.

CAL. .30, rounds (in box, M1 D44070 and belt C3951)	6250	16 boxes right front sponson 7 boxes in left spon- son over battery 2 boxes on gun
--	------	--

(2) EQUIPMENT.

BAG, empty cartridge, cal. .30 (flex bow gun)	1	On gun
BAG, empty cartridge, cal. .30 (turret)	1	On gun
BELT, ammunition, 250 rounds	25	In box, ammunition, cal. .30 M1 D44070
BOX, ammunition, cal. .30, M1	25	See ammunition stowage
BRUSH, chamber-cleaning, M6	1	Spare parts box right front sponson
BRUSH, cleaning, cal. .30, M2	6	Spare parts box right front sponson
CAN, tubular (w/o contents)	1	Spare parts box right front sponson
CASE, cleaning rod, M1	2	Spare parts box right front sponson
CASE, cover group	1	Spare parts box right front sponson
CASE, spare bolt, M2 (w/o contents)	4	Spare parts box right front sponson
COVER, muzzle, cal. .30 (flex bow gun)	1	On gun
COVER, muzzle, cal. .30 (turret)	1	On gun

VEHICLE STORAGE AND SPECIAL TOOLS

Item	Number Carried	Where Carried
COVER, receiver, cal. .30 (flex bow gun)	1	On gun
COVER, receiver, cal. .30 (turret)	1	On gun
COVER, spare barrel, cal. .30	2	On spare barrel
COVER, tripod mount, M2 (head cover)	1	On tripod, M2
Envelope, spare parts, M1 (w/o contents)	2	Spare parts box right front sponson
EXTRACTOR, ruptured cartridge, Mk IV	2	In small tool box 1 in turret 1 in right sponson
MOUNT, tripod, machine gun, cal. .30, M2	1	On floor next to wall under ass't driver
OILER, rectangular, 12-oz	1	Spare parts box
REFLECTOR, barrel, cal. .30	1	Spare parts box
ROD, cleaning, jointed, cal. .30, M1	2	One in each of two cleaning rod cases, M1-C6573
ROLL, spare parts, M13 (w/o contents)	2	Spare parts box
ROLL, tool, M12 (w/o contents)	2	Spare parts box
c. Caliber .50 Machine Gun M2.		
(1) AMMUNITION.		
CAL. .50 rounds (in box, M2-D73913)	600	6 boxes, right rear sponson
(2) EQUIPMENT.		
BAG, empty cartridge	1	On gun
BAG, metallic, belt link	1	On gun
BOX, ammunition, cal. .50, M2	6	See ammunition stowage
BRUSH, cleaning, cal. .50, M4	4	Spare parts box
CASE, cleaning rod, M15	1	Spare parts box
CHUTE, metallic, belt link, M1	1	On gun
COVER, barrel	2	On barrel
ENVELOPE, spare parts, M1 (w/o contents)	2	Spare parts box
EXTRACTOR, ruptured cartridge	1	Spare parts box
MOUNT, cal. .50 machine gun	1	In brackets on rear of turret

TM 9-759

9-10

TANK, MEDIUM, M4A3

Item	Number Carried	Where Carried
OILER, filling, oil buffer	1	Spare parts box
ROD, jointed, cleaning, M7	1	Spare parts box
d. Caliber .45 Submachine Gun M3.		
(1) AMMUNITION.		
CAL. .45, rounds (in 30 rd. clips D35506)	900	In cases D90242
(2) EQUIPMENT.		
CASE, cal. .45 submachine gun clip	5	2 in turret under radio, 3 in right front spare parts box
e. 2-Inch Mortar M3.		
(1) AMMUNITION.		
BOMB, smoke, 2-in.	12	3 in armored box in turret 9 in armored box in left sponson over battery box
(2) EQUIPMENT.		
BRUSH, bore-cleaning, 2-in. bomb thrower, Mk 1	1	Spare parts box
CATCH, hammer	1	Spare parts box
PIN, firing	1	Spare parts box
PIN, swivel, also catch	1	Spare parts box
SPRING, catch	1	Spare parts box
SPRING, catch, junction nut	1	Spare parts box
SPRING, main	1	Spare parts box
SWIVEL, hammer	1	Spare parts box
f. Hand Grenades.		
FRAGMENTATION, Mk 11	4	In turret
SMOKE, WP M15	4	In turret
SMOKE, colored, M16 or M18	4	In turret

10. GUN SPARE PARTS.**a. 75-mm Gun.**

FORK, firing pin cocking	1	Spare parts box
GASKET, recoil cylinder filling plug	2	Spare parts box
MECHANISM, percussion, assembly	1	Spare parts box
Consists of:		
Guide, (firing pin)	1	
Pin, firing	1	
Pin, straight, $\frac{3}{32}$ x $\frac{5}{8}$, firing pin guide	1	
Spring (firing pin retracting)	1	
Stop (firing spring)	1	

VEHICLE STOWAGE AND SPECIAL TOOLS

Item	Number Carried	Where Carried
PIN, cotter, 1/8 x 1 3/4	3	Spare parts box
PIN, firing	1	Spare parts box
PLUG, filling, recoil cylinder	2	Spare parts box
PLUNGER, cocking fork	1	Spare parts box
RETAINER, sear	1	Spare parts box
SPRING, cocking fork plunger	1	Spare parts box
SPRING, firing	1	Spare parts box
SPRING, (firing pin retracting)	1	Spare parts box
SPRING, sear	1	Spare parts box

b. Caliber .30 Machine Gun M1919A4.

BAND, lock, front barrel bearing	1	Spare parts box
BARREL	2	Lower hull, mounted vertically next to ass't driver
BEARING, barrel, front	1	Spare parts box
BOLT group	2	1 each in small spare parts boxes, located near each .30-cal. gun

Consists of:

Bolt, assembly	1	
Extractor, assembly	1	
Lever, cocking	1	
Pin, cocking lever	1	
Pin, firing, assembly	1	
Rod, driving spring, assembly ..	1	
Sear	1	
Spring, driving	1	
Spring, sear, assembly	1	
COVER group	1	Spare parts box
Consists of:		
Cover, assembly	1	
Lever, feed belt	1	
Pawl, feed belt	1	
Pin, belt feed pawl, assembly	1	
Pivot, belt feed lever, group assembly	1	
Slide, feed belt, assembly	1	
Spring, cover extractor	1	
Spring, feed belt pawl	1	

TM 9-759

10

TANK, MEDIUM, M4A3

Item	Number Carried	Where Carried
EXTENSION, barrel, group	1	Spare parts box
Consists of:		
Extension, barrel, assembly	1	
Lock, breech	1	
Pin, breech, lock, assembly	1	
Spring, locking barrel	1	
FRAME, lock, group	1	Spare parts box
Consists of:		
Accelerator	1	
Frame, lock, assembly	1	
Pin, accelerator, assembly	1	
Pin, trigger	1	
Plunger, barrel, assembly	1	
Spring, barrel plunger	1	
Spring, trigger pin	1	
Trigger	1	
LEVER, cocking	1	Spare parts box
LEVER, feed belt	1	Spare parts box
PAWL, feed belt	1	Spare parts box
PAWL, holding belt	1	Spare parts box
PIN, accelerator, assembly	1	Spare parts box
PIN, belt holding pawl, split	1	Spare parts box
PIN, cocking lever	1	Spare parts box
PIN, firing, assembly	1	Spare parts box
PIN, trigger	1	Spare parts box
SCREW, belt feed lever pivot	1	Spare parts box
SPRING, barrel plunger	1	Spare parts box
SPRING, belt feed pawl	1	Spare parts box
SPRING, belt holding pawl	2	Spare parts box
SPRING, cover extractor	1	Spare parts box
SPRING, locking barrel	1	Spare parts box
SPRING, sear, assembly	2	Spare parts box
SPRING, trigger pin	1	Spare parts box
TRIGGER	1	Spare parts box
WASHER, lock, toothed, S. Reg. No. 6	1	Spare parts box

c. Caliber .50 Machine Gun M3.

BARREL, assembly	1	In bracket on right side plate behind driver
DISK, muffler	1	Spare parts box
EXTENSION, firing pin, assembly	1	Spare parts box
EXTRACTOR, assembly	1	Spare parts box

VEHICLE STOWAGE AND SPECIAL TOOLS

Item	Number Carried	Where Carried
LEVER, cocking	1	Spare parts box
PIN, cotter, belt feed lever pivot stud	1	Spare parts box
PIN, cotter, cover pin	1	Spare parts box
PIN, cotter, switch pivot	2	Spare parts box
PIN, firing	1	Spare parts box
PLUNGER, belt feed lever	1	Spare parts box
ROD, driving spring, w spring assembly	1	Spare parts box
SLIDE, belt feed, group	1	Spare parts box
Consists of:		
Arm, belt feed pawl, B8914	1	
Pawl, feed belt, ass'y B8961	1	
Pin, belt feed pawl, ass'y B8962	1	
Slide, belt feed, ass'y B261110	1	
Spring, belt feed pawl, A9351	1	
SLIDE, sear	1	Spare parts box
SPRING, belt feed lever plunger	1	Spare parts box
SPRING, belt-holding pawl	1	Spare parts box
SPRING, cover extractor	1	Spare parts box
SPRING, locking barrel	1	Spare parts box
ING. sear	1	Spare parts box
OD, bolt	1	Spare parts box

11. SPECIAL TOOLS.

Name	Federal Stock Number	Mfr. Tool Number
Adapter, volute spring, removing	41-A-30-650	
Block, riser, bogie wheels	41-B-1411-200	
Compressor, suspension volute spring	41-C-2556	MTM-M3-3
Fixture, removing and replacing, power train assembly	41-F-2997-220	MTM-M3-165
Guide, bogie wheel gudgeon, installing (formerly 41-G-2500)	41-G-1235-505	MTM-M3-5
Indicator, top dead center, and timer	41-I-115	KRW-T-77
Lift, bogie wheel	41-L-1375	MTM-M3-813
Pin, alining, tapered, bolt-holes-to-power-train and hull points	41-P-555-600	MTM-M3-164
Pin, holding, tapered, power train assembly	41-P-647	
Puller, idler wheel	41-P-2940-800	MTM-M3-8
Puller, slide hammer type, bogie gudgeon	41-P-2957-27	

TM 9-759

11

TANK, MEDIUM, M4A3

Name	Federal Stock Number	Mfr. Tool Number
Replacer, bearing cups, inner bogie and 13-in. idler wheels, inner and outer 10-in. idler wheels		
Replacer, bearing cups, track rollers (inner and outer)	41-R-2385-350	
Screwdriver, special, adjusting	41-S-1652-500	KRW-T-59
Sling, radiator lifting	41-S-3332-86	TEC-50-63
Tool, idler wheel installing	41-T-3216-150	MTM-M3-9
Wrench, box, double offset, long, double hex, $\frac{9}{16}$ x $\frac{5}{8}$ in.	41-W-601-543	BF-2806L
Wrench, box special offset, carburetor heatbox nuts	41-W-639-850	KRW-T-40
Wrench, cylinder head nut, long	41-W-866-200	KRW-T-9
Wrench, cylinder head nut, short	41-W-866-250	KRW-T-29
Wrench, engineer's, 45- and 90-deg angle, dble hd, open end, $\frac{9}{16}$ -in. opening both ends (formerly 41-W-1465)	41-W-1059	
Wrench, pipe, chain, flat link, pipe capacity $\frac{5}{8}$ - to $4\frac{1}{2}$ -in., $1\frac{7}{8}$ in. long	41-W-1781-100	TEC-50-54
Wrench, set, socket, 1-in. sq drive, extra heavy duty, consisting of:	41-W-2622	TM-M3-16A
Bar, socket wrench, extension, 8 in. long, 1-in. sq drive (formerly 41-B-310-100)	41-B-310	SN-L-63
Bar, socket, wrench, sliding, 22 in.	41-B-312-200	MTM-M3-16L
Handle, tubular, 36-in. long, $1\frac{1}{8}$ in. inside diameter, $1\frac{7}{16}$ in. outside diameter	41-H-1408-50	MTM-M3-160
Head, ratchet, socket wrench, 1-in. sq drive	41-H-1838	MTM-M3-16M
Head, square, 1 in. male	41-H-1779-50	MTM-M3-16E
Wrench, socket, hex, 1-in. sq drive, $1\frac{1}{2}$ in.	41-W-3058-200	MTM-M3-16J
Wrench, socket, hex, 1-in. sq drive, $1\frac{3}{16}$ in.	41-W-3058-300	MTM-M3-16K
Wrench, socket, hex, 1-in. sq drive, $2\frac{1}{4}$ in.	41-W-3058-430	MTM-M3-16F
Wrench, socket, hex, 1-in. sq drive, $2\frac{3}{8}$ in.	41-W-3058-450	MTM-M3-16H

VEHICLE STOWAGE AND SPECIAL TOOLS

Name	Federal Stock Number	Mfr. Tool Number
Wrench, socket, hex, 1-in. sq drive, 2 $\frac{5}{8}$ in.	41-W-3058-480	MTM-M3-16K
Wrench, socket, splined, turning camshaft	41-W-2964-300	KRW-T-80
Wrench, socket, (detachable) 1-in. sq drive, 12-point dble hex opening 2 $\frac{1}{8}$ -in.	41-W-3059-40	SN-LDH-683
Wrench, spanner, track support roller retainer	41-W-3261	MTM-M3-11

TANK, MEDIUM, M4A3

PART TWO—OPERATING INSTRUCTIONS

Section IV

DRIVING CONTROLS AND INSTRUMENTS

12. DOORS.

a. **Driver's and Assistant Driver's Doors** (fig. 174). The doors provided for the driver and assistant driver on some vehicles are held open by means of a spring-loaded latch. On other vehicles the doors are held open or closed by a locking-type handle. To close the doors on the spring-loaded latch type doors, pull down on the latch lever, and at the same time pull the door closed. The doors may be secured from the inside by means of a sliding bolt latch.

b. **Escape Hatch** (fig. 175). The emergency escape hatch is located in the hull floor directly behind the assistant driver's seat. To open the hatch, lift the ratchet release, and kick the locking lever forward.

13. DRIVING CONTROLS.

a. **Brakes** (fig. 6).

(1) **SERVICE BRAKES.** Pulling back simultaneously on both steering levers slows down or stops the vehicle, depending on the effort applied.

(2) **PARKING BRAKES.**

(a) **Steering Lever Type.** The steering-lever type parking brake (fig. 7) is controlled by means of a foot pedal which operates a quadrant in conjunction with the steering brake control levers. To set the brakes, kick the pedal toward the rear (this will raise the quadrant into position to contact the pawls on the steering brake control levers), then pull hard on both levers. To release the brakes, pull back on both levers and push the pedal forward and down, then release the levers slowly. The brakes must be released before attempting to move the vehicle.

(b) **Transmission Type.** On some vehicles the parking brake is located at the rear of the transmission to the right of the driver. This design is a transmission-type brake, and must never be used for any purpose other than parking. To apply the parking brake, pull back on the lever. To release the brake, push the lever forward as far possible.

b. **Steering Levers** (figs. 6 and 7). Two steering levers are mounted on the floor of the vehicle in front of the driver's seat. To steer the vehicle, pull the steering lever on the side toward which it

DRIVING CONTROLS AND INSTRUMENTS

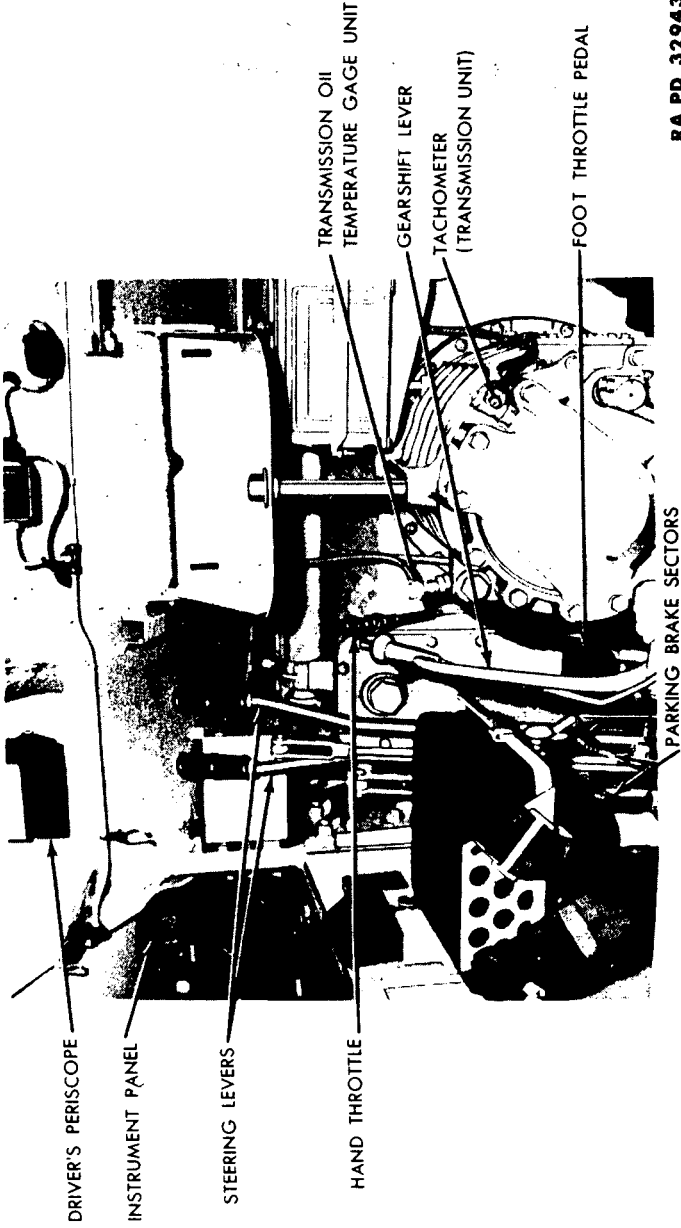

RA PD 329433

Figure 6—Typical Driver's Compartment (175-mm Dry Stowage Vehicles)

TANK, MEDIUM, M4A3

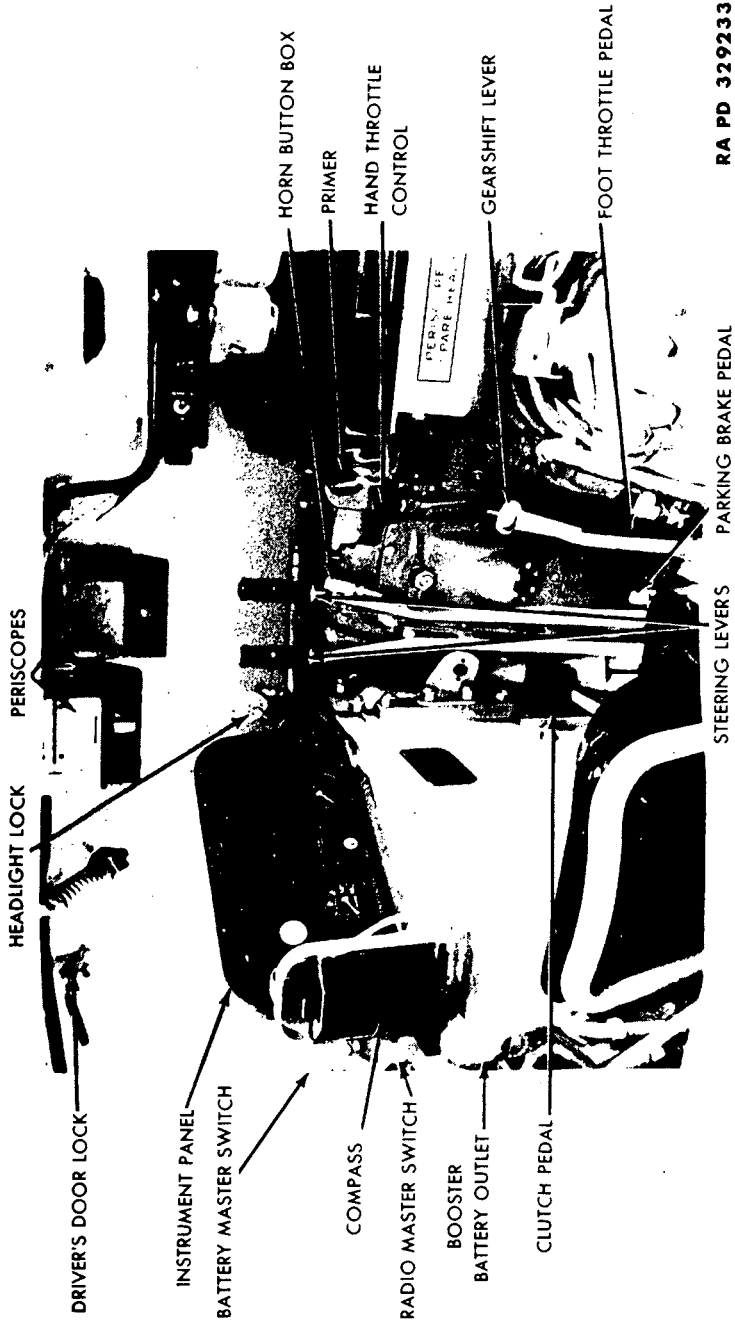

RA PD 329233

Figure 7—Typical Driver's Compartment (75-mm Wet Stowage, 76-mm, and 105-mm Howitzer Vehicles)

DRIVING CONTROLS AND INSTRUMENTS

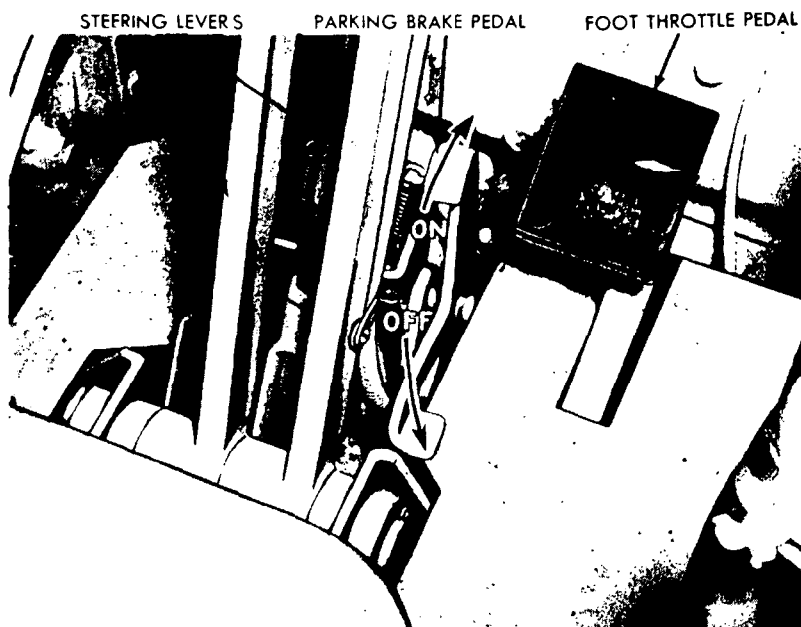

RA PD 329245

Figure 8—Parking Brake Controls (Later Vehicles)

is desired to turn. Pulling back either one of the levers slows down the track on that side, while the speed of the other track is increased.

c. **Throttle Controls** (figs. 7 and 8). A foot throttle pedal is located on the floor in front of the driver's seat, convenient to the driver's right foot. In conjunction with the foot pedal, a hand-operated throttle is provided, which is bracket-mounted to the differential case above the foot throttle. A lock button is located in the center of the hand throttle button. This lock button holds the hand throttle at the desired setting. To close the hand throttle, press the lock button. On 75-mm and 105-mm howitzer vehicles there is a two-speed idle mechanism connected to the throttle sleeve on the clutch cross shaft assembly at the rear of the driver's subfloor. When the clutch pedal is depressed, the stop screw on the engine carburetors should be adjusted (par. 72 c) so that the engine idles at 375 revolutions per minute. When the clutch pedal is in the engaged (fully back) position, the linkage of the two-speed idle mechanism should be adjusted to idle the engine at 800 revolutions per minute. This mechanism is incorporated so that the propeller shaft driven generator will charge the batteries when the vehicle is standing with the engine idling at

TANK, MEDIUM, M4A3

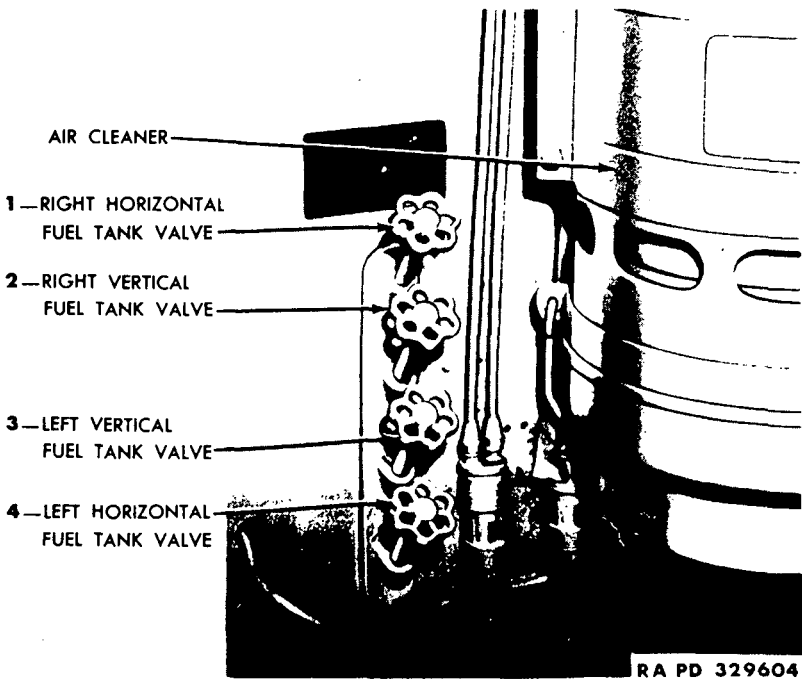

Figure 9—Fuel Shut-off Valves (75-mm Dry Stowage Vehicles)

800 revolutions per minute, and the gear shifting will be easier when engine idle drops to 375 revolutions per minute.

d. **Clutch** (fig 7). The clutch pedal is located on the floor in front of the driver's seat, convenient to the driver's left foot. To permit shifting of gears, the clutch is disengaged by depressing the clutch pedal. At any time that the clutch pedal free play becomes less than 2½ inches, the clutch pedal must be adjusted. **CAUTION: Do not ride the clutch pedal.**

e. **Fuel Shut-off Valves** (figs. 9 and 10). On wet stowage and 105-mm howitzer vehicles, two shut-off valves, one for each set of fuel tanks, are located on the right and left side of the bulkhead at the rear of the fighting compartment. On 75-mm dry stowage vehicles four fuel shut-off valves are provided (one for each tank) located on the fighting compartment bulkhead to the right of the transmission oil cooler (fig. 9).

f. **Primer** (fig. 7). A priming pump is located either to the right of the steering lever above the hand throttle or on the instrument

DRIVING CONTROLS AND INSTRUMENTS

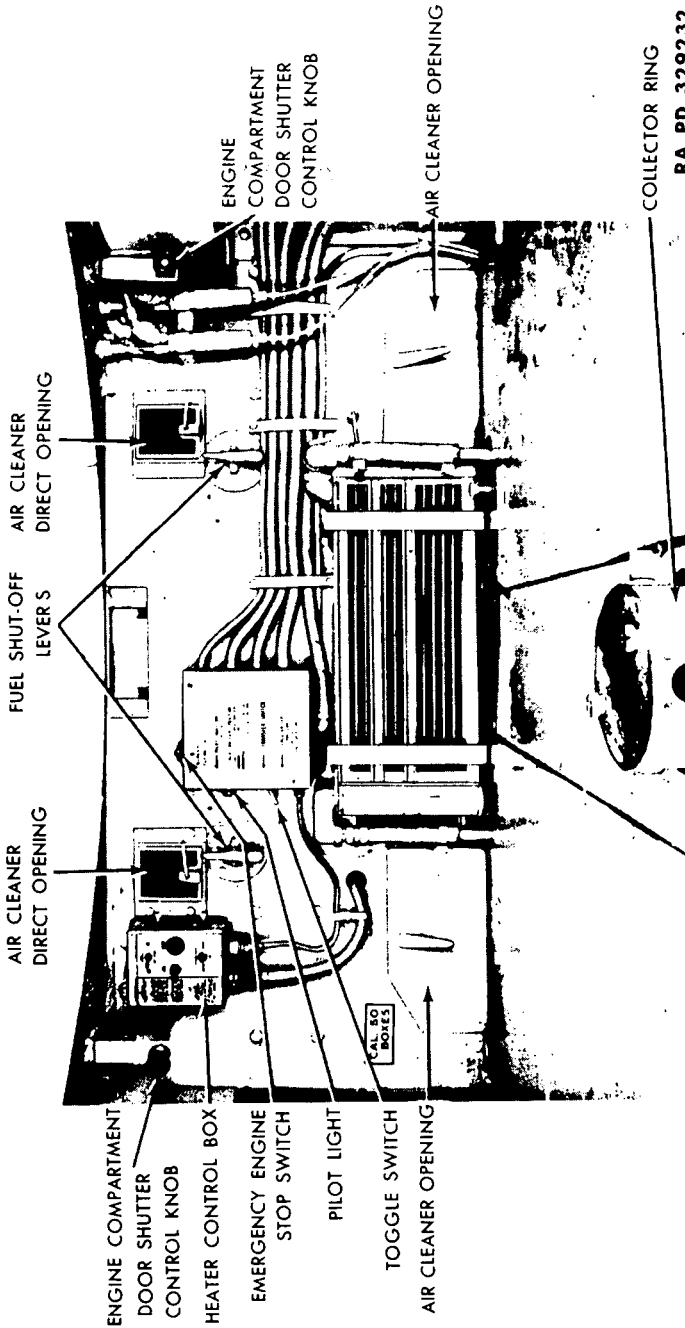
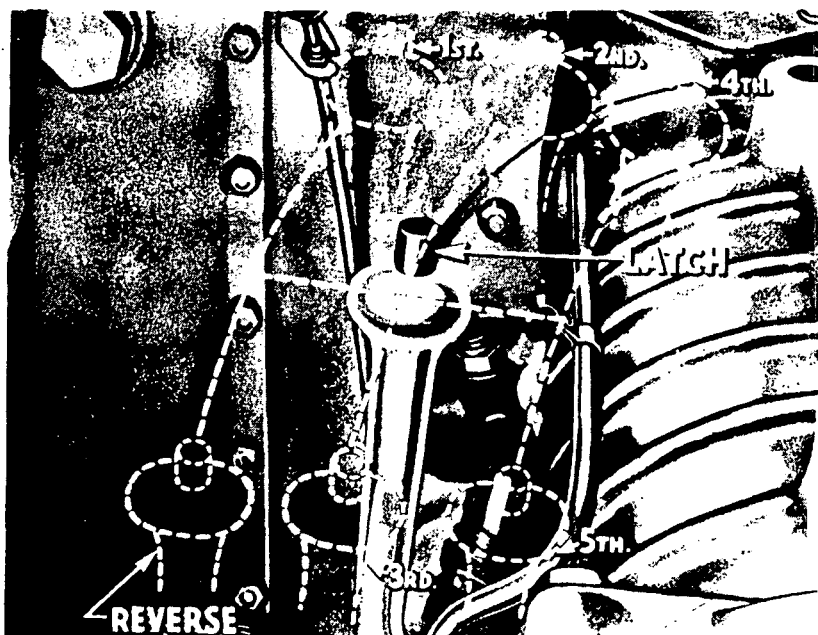

Figure 10—Typical Bulkhead, Fighting Compartment Side (75-mm Wet Stowage, 76-mm, and 105-mm Howitzer Vehicles)

TANK, MEDIUM, M4A3



RA PD 27493

Figure 11—Gearshift Lever Positions

panel on earlier models. To operate the primer, the knob is pulled out and pushed back in. This causes a quantity of gasoline to be forced directly into the intake manifold for cold weather starting. The priming pump is used in place of the conventional choke. Ordinarily it will not be necessary to use the primer except during cold weather. Excessive priming of the engine will cause flooding and failure to start, and the excess gasoline will wash the oil from the cylinder walls, with the result that the cylinders will not be properly lubricated until the engine oil starts circulating.

g. Gearshift Lever. Shifting of gears in the transmission is accomplished by means of the gearshift lever, located on the left side of the transmission, to the right of the driver. The positions of the gearshift lever for the various speeds are shown in figure 11. The gearshift lever is equipped with a latch which prevents accidental shifting into first speed or reverse. The latch must be released by pressing down the button on top of the lever before shifting into first speed or reverse.

h. Engine Compartment Door Shutter Controls. The engine compartment doors on some of the vehicles are provided with shutters

DRIVING CONTROLS AND INSTRUMENTS

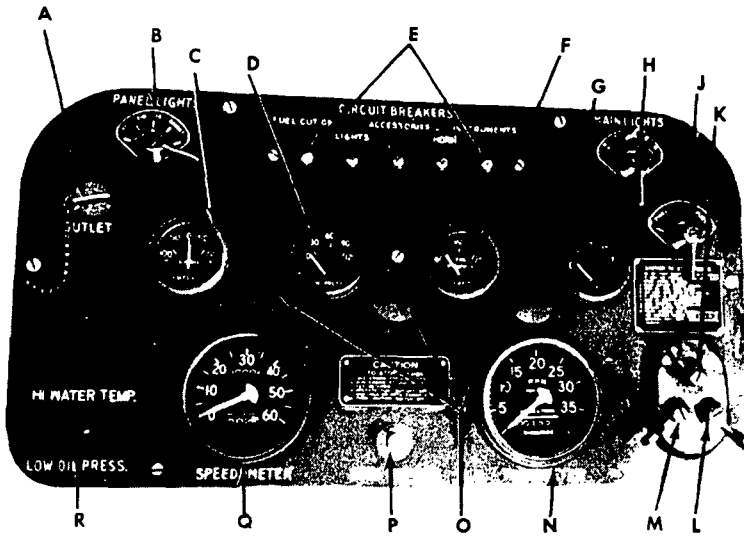

- A—UTILITY OUTLET
- B—PANEL LIGHT SWITCH
- C—AMMETER
- D—OIL PRESSURE GAGE
- E—CIRCUIT BREAKER RESET BUTTONS
- F—TEMPERATURE GAGE
- G—FUEL GAGE
- H—LIGHT SWITCH
- J—FUEL GAGE SELECTOR SWITCH
- K—IGNITION SWITCH
- L—STARTER SWITCH
- M—BOOSTER SWITCH (NOT USED)
- N—TACHOMETER
- O—PANEL LIGHT COVERS
- P—FUEL CUT-OFF
- Q—SPEEDOMETER
- R—HI WATER TEMPERATURE AND LOW OIL PRESSURE SIGNAL LIGHT

RA PD 329471

Figure 12—Typical Instrument Panel (75-mm Wet Stowage, 76-mm, and 105-mm Howitzer Vehicles)

controlled by cables, mounted on the rear bulkhead in the fighting compartment (fig. 10). These shutters should be closed only when operating the engine in cold weather. To open the shutters, push in on the control cable knob with the palm of the hand. To close the shutters, press in on the lock button with the thumb, and at the same time pull out on the knob.

TANK, MEDIUM, M4A3

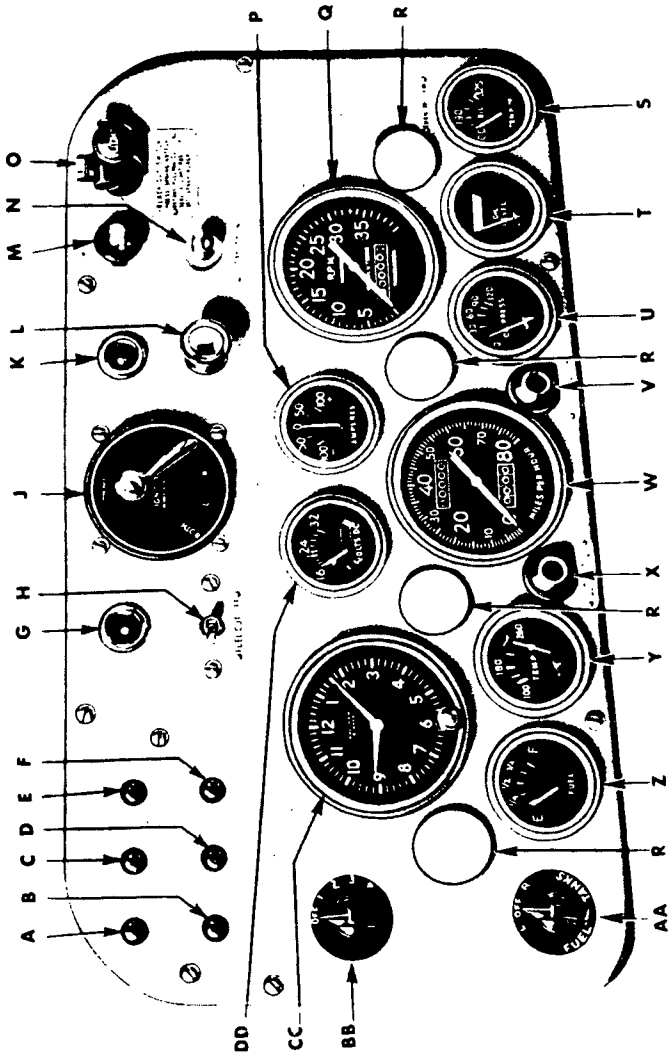

RA PD 27535

Figure 13—Typical Instrument Panel (Early 75mm Dry Storage Vehicles)

DRIVING CONTROLS AND INSTRUMENTS

- A — RIGHT-HAND UTILITY OUTLET CIRCUIT BREAKER
BUTTON
- B — SIREN CIRCUIT BREAKER BUTTON
- C — LEFT-HAND UTILITY OUTLET CIRCUIT BREAKER
BUTTON
- D — FUEL CUT-OFF AND HULL LAMPS CIRCUITS
BREAKER BUTTON
- E — BLACKOUT DRIVE SWITCH CIRCUIT BREAKER
BUTTON
- F — CIRCUIT BREAKER BUTTON FOR PANEL LIGHTS,
FUEL GAGE, WATER TEMPERATURE GAGE, LOW
OIL PRESSURE LIGHT, WATER BOIL SIGNAL
LIGHT, OIL LEVEL GAGE, VOLTMETER AND TRANS-
MISSION OIL TEMPERATURE GAGES
- G — UTILITY OUTLET
- H — FUEL CUT-OUT SWITCH
- J — IGNITION SWITCH
- K — UTILITY OUTLET
- L — ENGINE PRIMING PUMP
- M — BLACKOUT DRIVING LIGHT SWITCH
- N — STARTER SWITCH
- O — LIGHT CONTROL SWITCH
- P — AMMETER
- Q — TACHOMETER
- R — INSTRUMENT PANEL LIGHT COVER
- S — TRANSMISSION OIL TEMPERATURE GAGE
- T — OIL LEVEL GAGE
- U — OIL PRESSURE GAGE
- V — LOW OIL PRESSURE SIGNAL
- W — SPEEDOMETER
- X — ENGINE BOIL SIGNAL
- Y — ENGINE TEMPERATURE GAGE
- Z — FUEL LEVEL GAGE
- AA — FUEL SELECTOR SWITCH
- BB — PANEL LIGHT RHEOSTAT SWITCH
- CC — CLOCK
- DD — VOLTMETER

RA PD 27535A

Legend for Figure 13

TANK, MEDIUM, M4A3**14. INSTRUMENTS.**

a. **Ammeter** (figs. 12 and 13). An ammeter (B199959) is provided with a range of 100-ampere discharge to 100-ampere charge. If, during normal operation, when little current is being used, the ammeter consistently indicates discharge, refer to paragraph 43.

b. **Tachometer** (figs. 12 and 13). A tachometer is provided on the instrument panel. On the 75-mm dry stowage vehicles, the throttle stop screw on the carburetor should be so adjusted that the engine will idle at 500 revolutions per minute after warming up, and on the wet stowage and 105-mm howitzer vehicles, the throttle stop screw must be adjusted so the engine will idle at 800 revolutions per minute with the clutch pedal in a fully returned position (par. 72 c). If, during operation under full load, it is possible to run the engine at speeds above 2,600 revolutions per minute, or if the governor limits the speed at some point below 2,600 revolutions per minute, notify higher authority.

c. **Oil Pressure Gage** (figs. 12 and 13). An engine oil pressure gage (6208795) is provided on the instrument panel, and at normal temperatures the oil pressure should be between 60 and 110 pounds. If, during operation, the oil pressure suddenly drops off, immediately stop the engine. This fault may be due to low oil level. If oil pressure drops off slowly, it may be due to a change in the viscosity of the oil caused by overheating. Check the engine temperature.

d. **Engine Boil and Low Oil Pressure Signal** (figs. 12 and 13). A red jewel-type light on the panel signals the driver when the oil pressure drops below 8 pounds, or when the water temperature is higher than 235°F. On some earlier vehicles, two separate units are provided (fig. 13).

e. **Speedometer** (figs. 12 and 13). The speedometer is equipped with a trip mileage reset, located at the rear of the instrument panel.

f. **Engine Temperature Gage** (figs. 12 and 13). The engine temperature gage is calibrated either from 60°F to 260°F or from 100°F to 260°F. The cooling system is sealed, with the result that the boiling point of the coolant is raised, and overheating does not occur until a temperature of approximately 235°F is reached. In normal operation, under maximum power on a level, hard surface the engine temperature should not be greater than 90°F above atmospheric temperature.

g. **Fuel Level Gage and Selector Switch** (figs. 12 and 13). A selector switch and fuel level gage permit the checking of the fuel

DRIVING CONTROLS AND INSTRUMENTS

level in the fuel tanks. The selector switch has two "ON" positions, "R" and "L." With the selector switch in the "OFF" position, the fuel level gage (6209888) will read "E" (empty).

h. Engine Oil Level Gage (fig. 13). An engine oil level gage is provided on some earlier vehicles. It indicates whether sufficient oil is carried in the engine oil pan sump. As long as the oil level gage is in the green sector with the engine idling, the oil level is satisfactory. When the reading drops to the red sector, oil should be added to bring the oil level up to the 32-quart or "FULL" mark on the engine bayonet gage. Oil level gages are not supplied on vehicles of current production and are removed, when they become inoperative, from vehicles of early production (par. 92 b (6)).

i. Transmission Oil Temperature Gage (fig. 13). An oil temperature gage (6208797) having a range of from 100°F to 325°F is provided on some vehicles. It indicates the temperature of the oil in the transmission. In normal operation the temperature of the transmission oil should not exceed 200°F. The most common cause of overheating is too much oil in the transmission. Check the level of the transmission oil.

j. Compass (fig. 7). The driver's compass is mounted either on the front hull plate over the instrument panel or on the center of the front hull plate.

15. SWITCHES, CIRCUIT BREAKERS, AND UTILITY OUTLETS.**a. Light Switch.**

(1) **ROTARY TYPE** (fig. 12). On some vehicles a rotary-type switch (C136186) is provided, which includes the blackout driving light control. The switch is equipped with a safety button to prevent the switch being accidentally turned to other than blackout position. To release the safety button, push it with the thumb and at the same time turn the switch. The switch has four positions (besides "OFF") controlling the lights as marked on the switch.

(2) **PULL TYPE** (fig. 13). On other models the knob on the instrument panel marked "LIGHTS" controls the service lights and the blackout driving lights. A spring-operated safety button prevents the knob from being accidentally pulled out beyond the blackout position. To release the safety button, push the button in with thumb, at the same time continuing the outward pull on the knob with the

TANK, MEDIUM, M4A3

first and second fingers. The switch has three positions (besides "OFF") controlling the lights as follows:

Light Switch Position	Lights Operating	Location
Blackout— 1st position	Blackout marker lights	Top of right and left headlights
	Blackout taillights	Lower section right and left taillights
	Blackout stop light (when steering lever is pulled back)	Upper section right-hand taillight
Service— 2nd position	Service headlights	Right and left headlight
	Service taillight	Upper section left-hand taillight
	Service stop light (when steering lever is pulled back)	Upper section left-hand taillight
Stop light— 3rd position	Service stop light	Upper section left-hand taillight

(3) **BLACKOUT DRIVING LIGHT SWITCH** (fig. 13). The blackout driving light may be used to supply illumination for driving when the service driving lights might reveal the position of the vehicle. First, remove both service head lamps from their sockets at the front of the vehicle. Then insert the blackout driving lamp in the left front lamp socket. With the master light switch pulled out to first position, pull out on blackout driving light switch button to turn on driving light. The blackout headlight, marker lights, taillights and stop light will also be on with switches in this position. **CAUTION:** *Under battle conditions the blackout driving light should be used intermittently and only when absolutely necessary for safe vision.*

b. Instrument Panel Light Switch (figs. 12 and 13). A five-position rheostat switch C-102763 is provided which controls the brilliance of the panel lights.

c. Battery Master Switch (figs. 7 and 14). The battery master switch is located to the left of the driver on most vehicles; however, on some early vehicles the switch is located approximately 30 inches to the rear of the driver's seat. The switch is "ON" when the knob is all the way in. To turn the switch off, raise the knob and turn it so that the knob stays in the "OUT" position. When this switch is "OFF," all electrical power is shut off at the battery (with the exception of the power used by the radio, which is controlled by a separate radio master switch).

DRIVING CONTROLS AND INSTRUMENTS

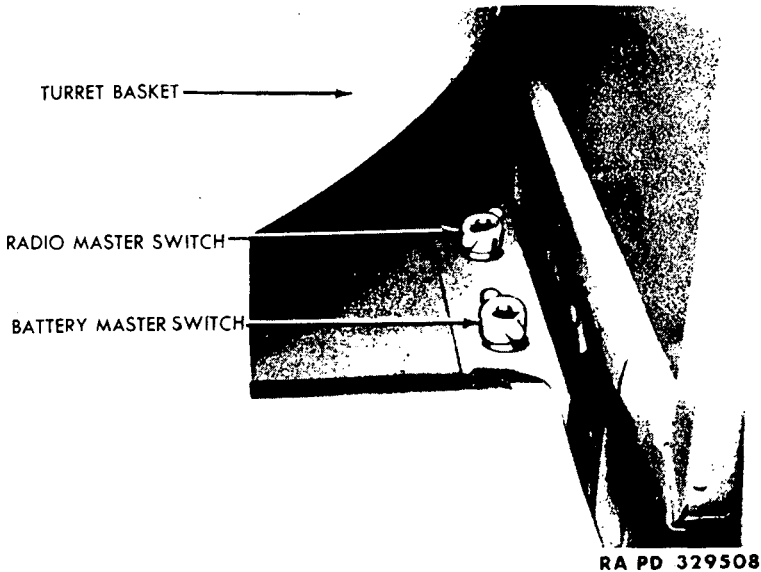

RA PD 329508

Figure 14—Battery and Radio Master Switches (Early 75-mm Dry Stowage Vehicles)

d. **Radio Master Switch** (figs. 7 and 14). The radio master switch is located next to, and is turned "ON" or "OFF" in the same manner as the battery master switch (subpar. c above).

e. **Ignition Switch** (figs. 12 and 13). The two 4-cylinder Bosch magnetos are controlled by a four-position rotary switch on the instrument panel. When the switch lever is turned to the "BOTH" position, both magnetos are "ON." When the switch lever is at the position marked "L," only the left-hand magneto is "ON," and the engine will run only on the left-hand four-cylinders (left or right is as viewed from the rear of the vehicle when facing in the direction the vehicle is headed). When the ignition switch lever is at the position marked "R," the right-hand magneto is "ON," and the engine will run only on the right-hand four cylinders.

f. **Starter Switch** (figs. 12 and 13). Either a starter switch or button is provided on the instrument panel. With the battery master switch "ON," turn the lever to the left (on early models push the starter button "IN"), this completes the circuit through the cranking motor relay closing the cranking motor circuit, causing the cranking motor to crank the engine.

TM 9-759

15-16

TANK, MEDIUM, M4A3

g. Fuel Cut-off (figs. 12 and 13). On the instrument panel a push button or a spring-located toggle switch marked "FUEL CUT-OFF" (G 103-17-93650) operates the carburetor degasser electrically. This shuts off the fuel from the idle fuel supply wells in the carburetor. When stopping the engine, always press this button in (on early models push the toggle switch to the right) and hold it in this position until the engine stops, before turning off the ignition.

h. Horn or Siren Button (fig. 7). A push button for sounding the horn or siren is provided and is located either on the right-hand steering lever, or is bracket-mounted directly above the clutch pedal.

i. Circuit Breakers. Circuit breakers are used in most of the various circuits, as shown in the different circuit drawings in section XIII, to protect the circuit from overload. When an overload occurs, the circuit breaker opens the circuit automatically. To again close the circuit, press the particular circuit breaker button. If the circuit breaker continues to open, refer to the paragraph and symptom that applies in section XIII (Trouble Shooting).

j. Utility Outlets (figs. 12 and 13). Utility outlets are provided on the instrument panel that permit plugging in a trouble light, a hatch hood windshield wiper power plug, etc.

Section V

OPERATION UNDER ORDINARY CONDITIONS

16. USE OF INSTRUMENTS AND CONTROLS IN VEHICULAR OPERATION.

a. New Vehicle Run-in Test. Before a new or reconditioned vehicle is placed in service, be sure that the new vehicle run-in test described in paragraphs 31, 32, and 33 has been performed.

b. Before-operation Service. Perform the services in items (1) through (6) in paragraph 35 b before attempting to start the engine. Start and warm up the engine (subpar. c (2) below), and complete the before-operation services.

c. Starting the Engine.

(1) **PRELIMINARY INSTRUCTIONS.** Before attempting to start the engine, familiarize yourself with all the various instruments and controls as outlined in paragraphs 13, 14, and 15. Make sure that the function of each instrument and control is thoroughly understood, and that the significance of the readings on the various instruments is appreciated.

OPERATION UNDER ORDINARY CONDITIONS

(2) **WARM WEATHER STARTING.** If the vehicle is equipped with engine compartment door shutters, make sure they are open. If the fuel tanks are full, open all fuel shut-off valves, and run the vehicle for 30 minutes to provide expansion space for the fuel. After 30 minutes of operation, all but one fuel valve may be closed and the vehicle can be operated off any one fuel tank. Turn the battery master switch to the "ON" position. Put the gearshift lever in neutral. Press the foot throttle pedal, and pull the hand throttle out about $\frac{1}{4}$ -inch. Turn the ignition switch to the "BOTH" position. If the engine is cold, prime it with one to three quick strokes of the primer. Turn the starter switch lever to the left (press the starter button on early models). The engine should start readily. If it does not continue to run, repeat the priming.

(3) **COLD WEATHER STARTING.** If the temperature is lower than 10°F , and the vehicle is equipped with engine compartment door shutters, make sure the shutters are closed. If the temperature is below 0°F , see paragraph 25. Close the battery master switch. Put the gearshift lever in neutral. Press the foot throttle pedal, and pull the hand throttle out about $\frac{1}{4}$ inch. Turn the ignition switch to the "BOTH" position. Prime the engine with five or six quick strokes of the primer. Turn the starter switch lever to the left (or press the starter button on early models). Hold the clutch pedal all the way down while the cranking motor is cranking the engine. As the engine starts, two or three quick strokes of the foot throttle pedal will assist in keeping the engine running by supplying additional fuel.

d. Operation of the Vehicle.

(1) **PRELIMINARY INSTRUCTIONS.** Before attempting to drive the vehicle, the prospective driver should be thoroughly familiar with all the instruments and the significance of their readings. He must also know the function and operation of all the controls in his compartment. Review of paragraphs 13, 14, and 15 will be helpful. The limitations of the vehicle and engine are covered under paragraph 5 a.

(2) **SETTING THE VEHICLE IN MOTION.** With the engine at idling speed, and all instruments showing normal readings, the driver may now operate the vehicle. Disengage the clutch by pressing the clutch pedal down to the floor and holding it down. Move the gearshift lever into second gear position (fig. 11) for normal operation (first gear will be used only when shifting vehicle in buildings or over obstacles). Gradually release the clutch pedal, at the same time depressing the foot throttle. When the vehicle has started, and is moving with an engine speed of 1,200 revolutions per minute, release the foot throttle, depress the clutch again, and move the gearshift lever into the third gear position. Release the clutch and

TM 9-759

16-17

TANK, MEDIUM, M4A3

again depress the throttle to pick up the load of the vehicle. Repeat the above procedure until the highest gear is reached, which will enable the vehicle to proceed at the desired speed without causing the engine to labor. Do not ride the clutch. The driver's left foot must be completely removed from the clutch pedal while driving, to avoid unnecessary wear, and burning out the clutch. **NOTE:** *Do not move the vehicle in or out of close quarters without the aid of personnel outside of the vehicle to serve as a guide.*

(3) **STEERING THE VEHICLE.** To steer the vehicle, pull back the right-hand steering lever to make a right turn, or the left-hand lever for a left turn. This action applies the brake to the track on the inside of the turn, and speeds up the outside track. The driver should anticipate each turn, and be ready to apply more power as it is needed to compensate the braking effort. The hands should be free of the steering levers when not actually steering the vehicle.

(4) **BACKING THE VEHICLE.** Backing the vehicle should never be attempted unless an observer is stationed in front to guide the driver. To place the vehicle in reverse gear, a complete stop must be made. The throttle must be closed until the tachometer reads 500 revolutions per minute (lowest idling speed). Depress the clutch pedal, and move the gearshift lever to the reverse position (fig. 11).

(5) **USE OF GAGES ON THE INSTRUMENT PANEL.** The tachometer and the oil pressure gage give the most satisfactory indications of the engine's performance. Should the indications of these instruments appear to be irregular, the engine should be stopped and the cause investigated.

(6) **STOPPING THE VEHICLE.** To stop the vehicle, release the throttle and pull back on both steering levers at the same time. Depress the clutch pedal when the vehicle has slowed down to approximately 2 to 5 miles per hour, depending upon which gear is being employed before stopping.

(7) **STOPPING THE ENGINE.** After completing a run, the engine must be allowed to operate at 500 revolutions per minute for 2 minutes to assure a gradual and uniform cooling of the valves and other engine parts. To stop the engine, press the fuel cut-off button until the engine stops (on early models push the fuel cut-off toggle switch and hold it in this position), then turn the ignition switch to the "OFF" position.

17. TOWING THE VEHICLE.

a. **Equipment.** A towing shackle is mounted on each corner of the hull. Two of these shackles are mounted in front, and two in the rear. These shackles provide a quick method of attaching either a towing bar or cables.

OPERATION UNDER ORDINARY CONDITIONS

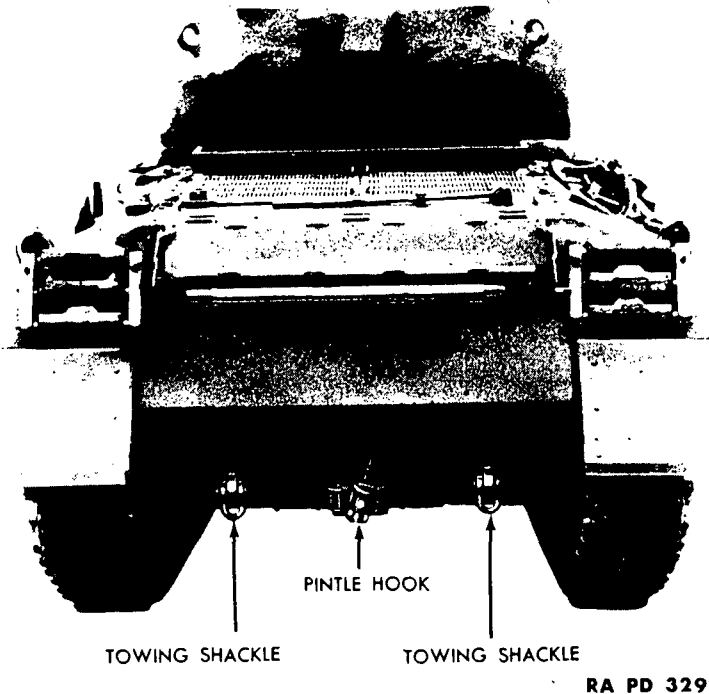

RA PD 329250

Figure 15—Towing Shackles and Pintle Hook (Later Vehicles)

b. Towing a Disabled Vehicle.

(1) **PRECAUTIONS.** If there are tracks on the vehicle to be towed, always disconnect the propeller shaft at the transmission companion flange, and leave the vehicle in fifth gear. The procedure insures adequate circulation of the transmission oil while the vehicle is in motion. If the tracks are removed before towing the vehicle, this precaution is not necessary. In towing, there are several precautions that the driver must take to avoid trouble or unnecessary delay. Changes of direction are always to be made by a series of slight turns so that the vehicle being towed is, as nearly as possible, directly behind the one doing the towing, or "tracking." **NOTE:** *This will prevent the cable from contacting the track, which might ruin both the cable and the track blocks.* The maximum speed when towing should be not more than 12 miles per hour, and then only with an operator for steering and braking the towed vehicle. If no operator is available to steer the disabled vehicle, one cable will facilitate tracking of the towed vehicle. **NOTE:** *When turning, take care not to get the cable tangled up with the track of either vehicle. Except in cases where a "short hitch" is absolutely necessary, a towing cable will not be coupled to another vehicle by other than the thimble*

TM 9-759

17-18

TANK, MEDIUM, M4A3

eyes provided at both ends. Doubling the cable causes sharp bends in the wire rope which will cause rapid failure of the strands, and will leave the cable extremely dangerous to handle. When a "short hitch" is desired, the two eyes of the cable are attached to the towing vehicle. The cable, with leads crossed, is then passed through both shackles of the towed vehicle. This provides an arrangement having a minimum of bending action and movement at the shackles, and furnishes clearance between cable and tracks.

(2) **TOWING ON MUDDY OR IRREGULAR TERRAIN.** Soft, muddy ground is to be avoided, since the tracks may slip on such a surface. If it is necessary to cross a muddy area, the driver should be careful to straighten out both vehicles before entering it, as it is more difficult to pull a vehicle at an angle than when following in tow. On vehicles equipped with rubber block tracks, grousers may be installed as required.

c. **Towing to Start.** If the engine is forced to turn over while there is water or antifreeze in the cylinder above the pistons (as a result of condensation or leakage), breakage of internal parts of the engine will result. Turn the engine over two complete revolutions by hand (fig. 81) prior to towing. Never use other than fifth gear when towing the vehicle to start the engine.

(1) **TURN ENGINE OVER.** Turn the ignition switch off. Tow the vehicle several feet with the transmission in neutral (fig. 11) to remove the slack from the towing line, and to break the track loose from the ground. Depress the clutch, and place the gearshift lever in fifth gear (fig. 11). Tow the vehicle at 1 mile per hour, and engage the clutch gradually (permitting it to slip) until two complete revolutions of the engine have been made. If the engine will not turn over with the clutch slipping, discontinue attempting to start, and notify higher authority.

(2) **START THE ENGINE.** After the engine has been turned over as outlined above, turn the ignition switch on and engage the clutch. Increase towing speed to from 3 to 5 miles per hour (in fifth gear, fig. 11) and make from three to five strokes with the priming pump. If the engine does not start, see paragraph 41 b. (1).

Section VI

TURRET CONTROLS AND OPERATION

18. CONTROLS.

a. Turret Locks.

(1) **WHEEL TYPE** (fig. 17). To unlock the turret, turn the wheel on the turret lock counterclockwise as far as it will go. To lock the turret, turn the wheel clockwise as far as it will go. The turret

TURRET CONTROLS AND OPERATION



RA PD 329503

Figure 16—Turret Controls (76-mm Vehicles)

TANK, MEDIUM, M4A3

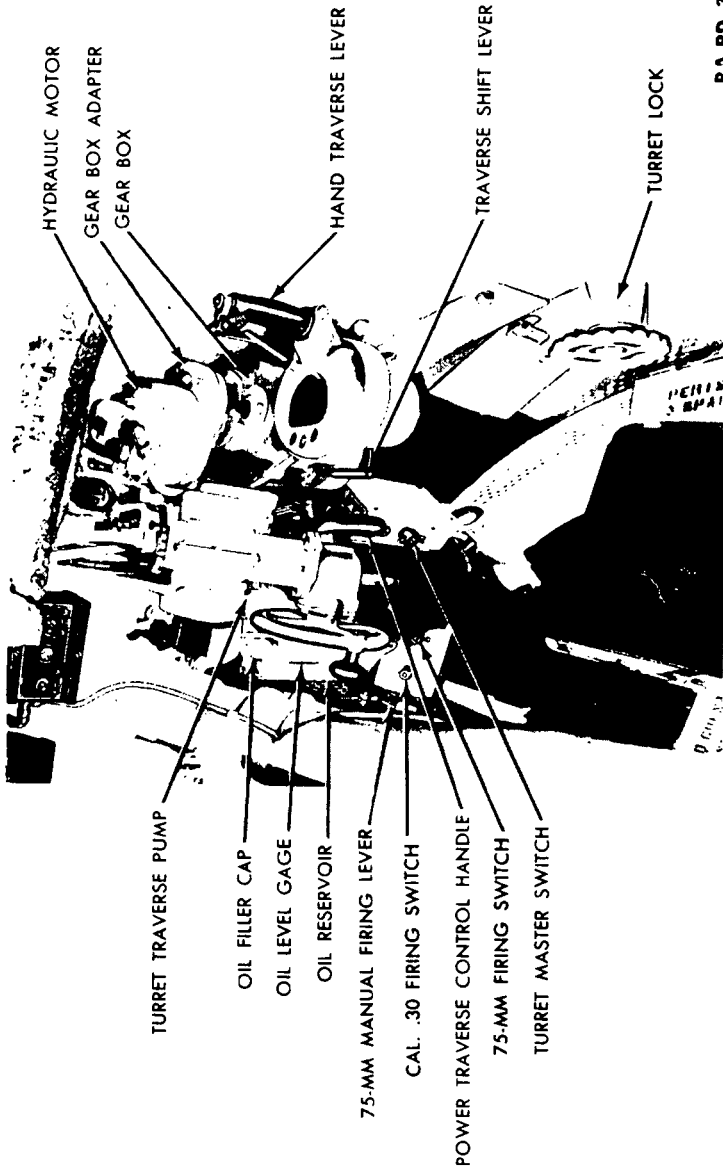

RA PD 329530

Figure 17—Turret Controls (75mm) Dry Storage Vehicles

TURRET CONTROLS AND OPERATION

RA PD 329510



Figure 18—Turret Controls (75-mm Wet Stowage Vehicles)

TANK, MEDIUM, M4A3

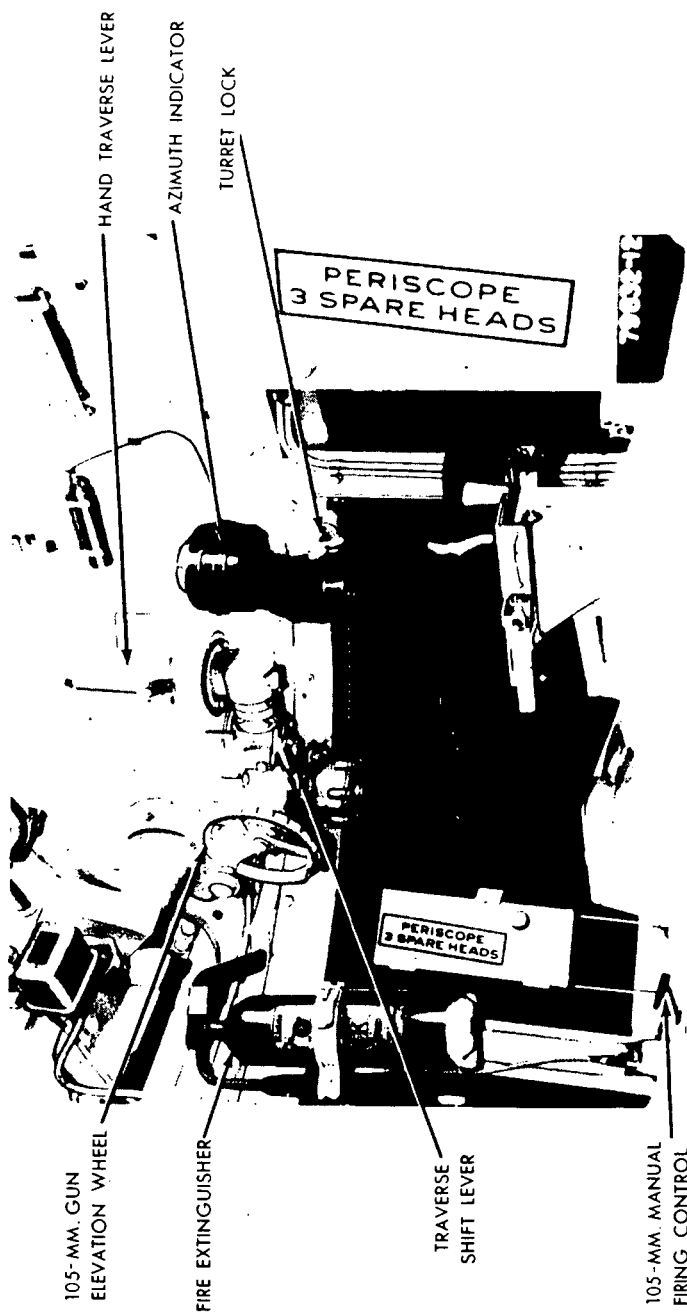

RA PD 329404

Figure 19—Turret Controls (105-mm Howitzer Vehicles)

TURRET CONTROLS AND OPERATION

They have to be rotated slightly by hand to engage the turret lock into the ring gear.

(2) **LEVER TYPE** (fig. 18). Disengage the turret lock by turning the lever one-quarter turn clockwise and at the same time pulling the lever outward so that the lugs on the lever shaft come through the lock bracket, then turn the lever one-quarter turn counterclockwise. To lock the turret, turn the lever one-quarter turn clockwise so that the lugs on the lever shaft go through the lock bracket, then turn the lever one-quarter turn counterclockwise.

b. **Shift Lever** (fig. 17). All M4A3 vehicles with the exception of the 105-mm howitzer are equipped with power traversing mechanism. To engage the shift lever to the power position, disengage the turret lock (subpar. a (1) and (2) above). Rotate the hand traverse lever (subpar. c below) slightly and at the same time push the shift lever upward until the manual traverse mechanism is disengaged. This places the shift lever in the power position. To shift into manual traverse, rotate the hand traverse lever slightly and at the same time push down on the shift lever until it is engaged into manual traverse. The M4A3 medium tank with the 105-mm howitzer is also equipped with a shift lever (fig. 19); however, when this lever is in the up position, the traversing mechanism will be in neutral position.

c. **Hand Traverse Lever** (fig. 17). To operate the hand traverse lever, squeeze the lever and at the same time rotate it in the direction desired. The turret rotates in the same direction as the lever. Releasing the hand lever applies a brake in the hand traverse drive.

19. OPERATION.

a. **Manual.** Before traversing the turret, if the vehicle is equipped with a gun traveling lock, be sure the gun is free of the lock, and that the driver's and assistant driver's doors are closed. Make sure personnel are clear of rotating parts. Disengage the turret lock. Engage the shift lever into manual position (par. 18 b). Rotate the hand traverse lever.

b. Power.

(1) **POWER ROTATION OF TURRET BY GUNNER** (figs. 16, 17, and 18). Refill the reservoir with hydraulic oil if the oil is below one-half inch from the top of the gage. Disengage the turret lock (par. 18 a (1) and (2)). Turn the battery master switch and the traversing switch to the "ON" position. This will start the electric motor and the hydraulic pump. Place the shift lever on the gear box to the power operating position (par. 18 b). Grasp the valve

TANK, MEDIUM, M4A3

control handle and turn it in the direction the turret is to be traversed. The farther the valve control handle is turned, the faster the turret will traverse. Release the valve control handle to stop the turret from traversing. When the turret traversing mechanism is not in use, lock the turret (par. 18 a (1) and (2)) and turn off the traversing switch.

(2) **POWER ROTATION OF TURRET BY COMMANDER.** Some vehicles are equipped with a commander's turret control (figs. 16 and 18). To traverse the turret using the commander's control, grasp the control handle and press the release button down, at the same time push the lever forward to rotate the turret counterclockwise, or pull the lever back to rotate the turret clockwise. The farther the handle is moved, the faster the turret will be traversed. Set the handle back to vertical position to stop the turret from rotating.

Section VII**OPERATION OF AUXILIARY EQUIPMENT****20. AUXILIARY GENERATOR.**

a. **Description** (figs. 20 and 21). The auxiliary generator, mounted at the rear end of the left sponson in the fighting compartment, is a self-contained generating unit. It is used to charge the vehicle batteries at such times as the use of the stabilizer unit, traversing motor, gun firing solenoids, radio and interphone installations impose too heavy a load on the electrical system. The control panel on the auxiliary generator contains a starting button, for starting the unit electrically, a circuit breaker reset button, and an ammeter. The button for stopping the engine is on the magneto cover. The normal charging rate with discharged batteries is 50 amperes. With fully charged batteries and no current being used, the rate should be from 3 to 5 amperes. A separate fuel tank for the unit has a capacity of 5 gallons, and is filled through a filler hole in the hull above the generator (subpar. c below).

b. **When to Use Auxiliary Generator.** The auxiliary generator should be kept in operation when any of the turret electrical units, such as the traversing or stabilizing mechanisms, are in use. On some vehicles the unit may also be used to preheat the engine compartment or the batteries in cold weather.

c. **Fuel Mixture.** Use a mixture of $\frac{3}{8}$ -pint of engine oil to 1 gallon of gasoline, and mix thoroughly before pouring it into the fuel tank. Thorough mixing of the oil and gasoline is essential to

OPERATION OF AUXILIARY EQUIPMENT

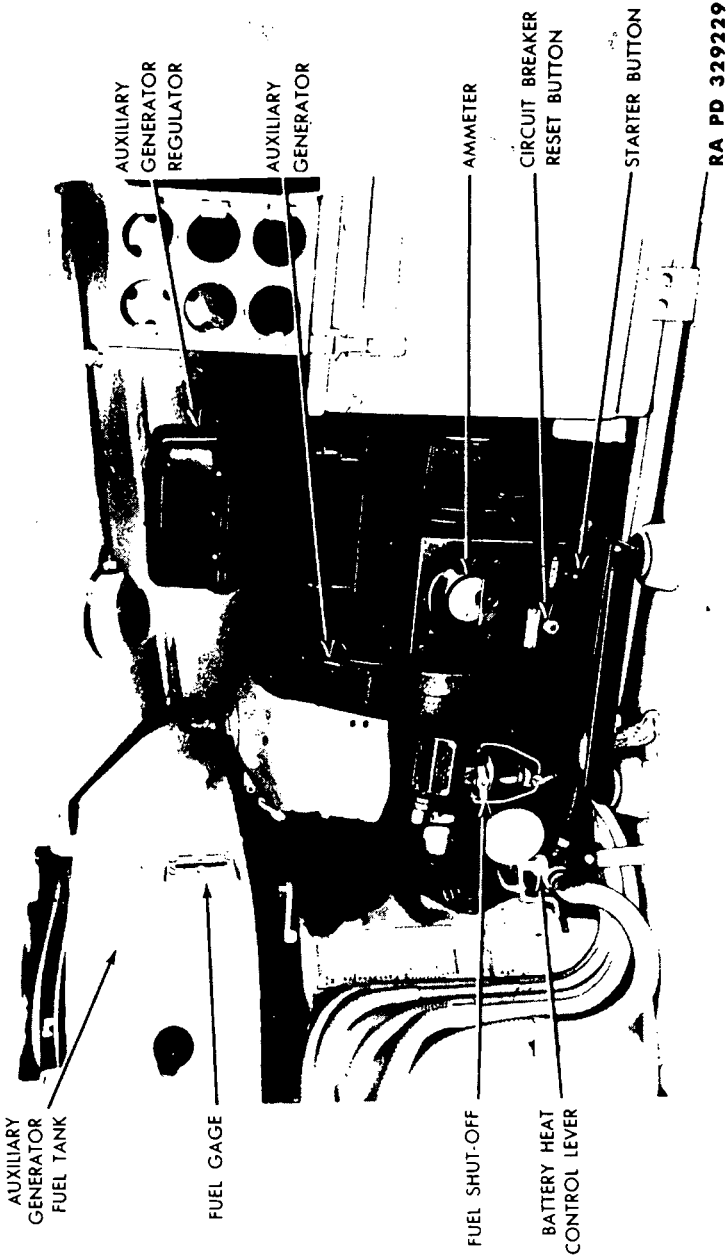
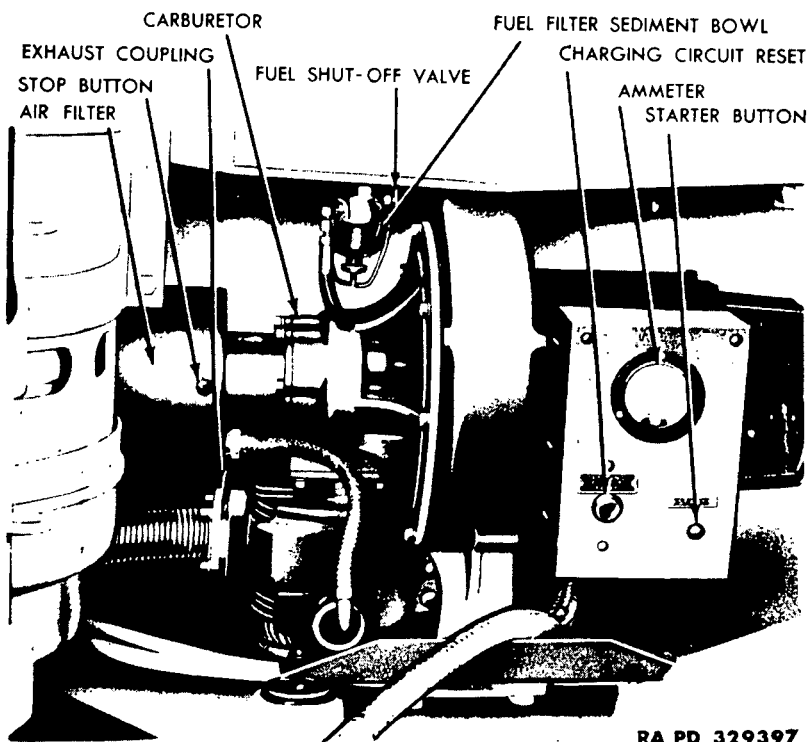

Figure 20—Auxiliary Generator and Regulator (Later Vehicles)

TANK, MEDIUM, M4A3



RA PD 329397

Figure 21—Auxiliary Generator (Early Vehicles)

prevent fouling of the spark plug, and for proper lubrication of the engine.

d. **Cold Weather (below 10°F) and Cold Engine Starting.** Close the battery master switch. Turn the shut-off cock at the fuel outlet in the bottom of the fuel tank counterclockwise to open it. Turn the shut-off cock on the fuel filter (fig. 20) counterclockwise to open it. Pull the choke on top of the carburetor away from the stop pin. Press the starting button on the control panel. Release the starting button as soon as the engine starts, and open the choke partially, easing it to fully opened position as the engine warms up.

e. **Warm Weather (above 50°F) or Warm Engine Starting.** Close the battery master switch. Turn the shut-off cock on the fuel tank (fig. 20) counterclockwise to open it. Turn the shut-off cock on the fuel filter counterclockwise to open it. Press the starting button on the control panel. Release the starting button

OPERATION OF AUXILIARY EQUIPMENT

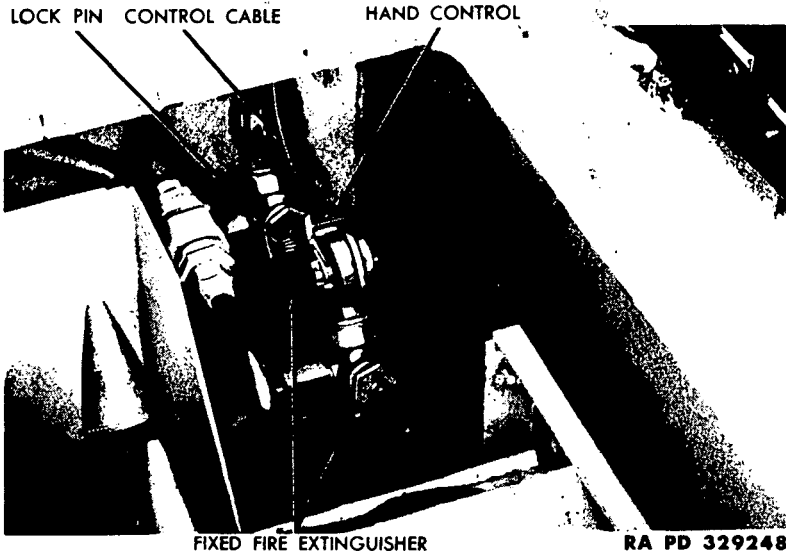

Figure 22—Typical Fixed Fire Extinguishers

as soon as the engine starts. Do not use the choke unless the engine does not start within 5 seconds.

f. **Emergency Manual Starting.** Wind the starting rope on the starting plate and, with the choke closed, give the rope a quick, hard pull to spin the engine. If the engine fails to start, repeat the procedure.

g. **Stopping the Generator Engine.** Press the stop button on the magneto, and hold it in firmly until the engine stops. Turn off the fuel shut-off cock.

21. FIRE EXTINGUISHERS.

a. Fixed Fire Extinguisher.

(1) **DESCRIPTION** (fig. 22). The fixed fire extinguisher system consists of two 10-pound cylinders charged with carbon dioxide (CO_2). The cylinders are bracket-mounted to the hull floor at the left rear corner of the fighting compartment. These cylinders are connected by tubing to the six discharge nozzles in the engine compartment. The system is controlled from the outside or inside of the vehicle by means of control cables.

TANK, MEDIUM, M4A3

FIXED FIRE EXTINGUISHER CONTROL HANDLES



RA PD 329247

Figure 23—Typical Driver's Fixed Fire Extinguisher Controls

(2) OPERATION.

(a) *Outside Controls* (fig. 24). Pull the handles marked "FIRE PULL" located outside and to the rear of the turret, and adjacent to the left fuel tank filler cap.

(b) *Inside Controls*. Pull the control handles marked "FIRE PULL" located on the hull ceiling above and to the rear of the driver's seat (fig. 23), or by removing the lock pin in the control head and rotating the lever marked "PUSH" on one side and "PULL" on the other (fig. 22).

b. **Portable Fire Extinguishers.**

(1) **DESCRIPTION.** One portable 4-pound fire extinguisher is installed in the vehicle just forward of the assistant driver's seat, or to the left of the driver on the left sponson, and another is installed on the turret platform wall.

(2) **OPERATION OF PORTABLE FIRE EXTINGUISHERS.** Remove the extinguisher from the bracket. With the cylinder in an upright position, squeeze the trigger and direct the discharge at the base of the flame, working upward. Continue the discharge after the flames

OPERATION OF AUXILIARY EQUIPMENT

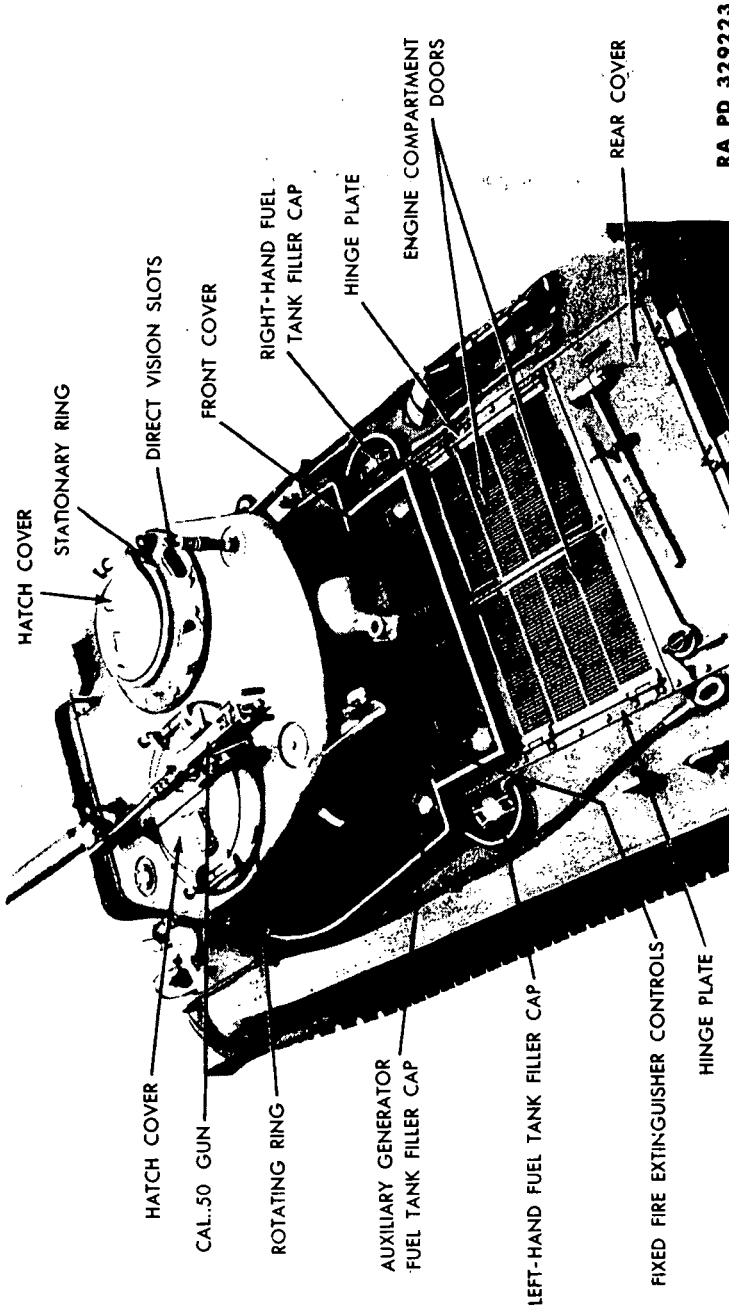

RA PD 329223

Figure 24—Typical M4A3 Vehicle As Viewed From Above Left Rear Corner

TANK, MEDIUM, M4A3

are out, to coat the hot material with carbon dioxide snow. Repl used extinguishers with fully charged ones at once. **CAUTION** *A cylinder containing gas under high pressure is as dangerous as a loaded shell; therefore, do not drop, strike, or expose to unnecessary heat.*

22. WINDSHIELD.

a. A detachable windshield and hood, equipped with an electric wiper and defroster (fig. 123), is provided for the driver's use during bad weather. The plug on the electric cord is to be inserted in the utility outlet in the instrument panel.

23. VENTILATING FANS.

a. **Description.** A ventilating fan is provided in the hull and in the turret on some of the M4A3 vehicles (fig. 116).

b. **Operation.** The battery master switch must be in the "ON" position. Push the toggle switch lever, located on the fan motor, to the "ON" position. The flow of air can be directed as desired by turning the air horns. To turn the fan off, push the toggle switch lever to the "OFF" position.

24. PERISCOPES.

a. **Description.** The driver and the assistant driver each have two periscopes, one in each of the hatch doors above them, and one adjacent to each door (figs. 2, 3, 4, and 5). Periscopes that are mounted in hatch doors on all M4A3 vehicles can be rotated through 360 degrees, and can be tilted approximately 30 degrees up or down. Housings may also be tilted to provide observation vertically. Periscopes are equipped with forehead rest which permit movement of the housing by means of the driver's head.

b. **Operation.** The rubber weather-seal, fastened around the inside top edge of the housing, may be used as a wiper. This is done by releasing the knurled nut on the back of the housing and the safety catch, and then moving periscope up and down in the housing by means of the handles. All periscopes are interchangeable, and, in the event of damage, the periscope heads are quickly replaceable (par. 140 b) from the spares carried in the vehicle.

Section VIII**OPERATION UNDER UNUSUAL CONDITIONS****25. EXTREME COLD.**

a. **General.** Operation of this equipment at subzero temperatures presents problems which do not exist at moderate temperatures. Consequently, operating and maintenance personnel m

OPERATION UNDER UNUSUAL CONDITIONS

Provide special precautions and extra careful servicing to avoid functional failure. Systems most likely to suffer from extreme cold are lubrication, fuel, cooling, and electrical (battery). In addition, the strength of metals is seriously lowered at extremely low temperatures. Inspect vehicle frequently for broken screws, bolts, or other metal parts, and for loosened nuts. Shock resistance of metals is greatly impaired by extremely cold temperature; stress and strain, due to jolting on frozen ground, is increased. Exercise care in moving the vehicle from a warm place into subzero temperature. Moisture will immediately condense and freeze on all exposed surfaces.

b. Deep Mud, Snow, and Ice. When operating in deep mud, snow and ice, clean caked mud or ice from the vehicle frequently. Do not allow mud, snow, or ice to cake on the tracks and bogies. Keep these substances off all electrical connections.

c. Cold Weather Accessories. Cold weather kits are furnished with some of the vehicles. Use of kit components will simplify cold weather operation and maintenance. Complete instructions for the use of this equipment accompany the kit.

d. Cold Weather Preparation. Prepare the vehicle for cold weather operation by following the instructions in subparagraphs **e**, **g**, **h**, and **i**, which follow.

e. Engine Lubrication System.

(1) Methods for keeping crankcase oil sufficiently fluid for proper lubrication are listed below in order of preference:

(a) Keep vehicle in a heated enclosure when not in use.

(b) When engine is stopped, drain crankcase oil while still hot. Tag vehicle in a conspicuous place in the driver's compartment to warn personnel that crankcase is empty. Store oil in a warm place if possible. Otherwise heat oil before reinstalling. **CAUTION: Do not overheat oil; heat only to a point where bare hand can be inserted without burning.**

(c) Dilute crankcase oil with gasoline, or, in an emergency, with Diesel fuel. If gasoline is used as a diluent, fill engine crankcase to the "FULL" mark with the grade of engine oil prescribed for use at temperatures from +32°F to 0°F (par. 29 d). Add 9½ quarts of gasoline to the crankcase. Run the engine 5 to 10 minutes to mix the lubricant and diluent thoroughly. Stop the engine and note that the level of the diluted oil is above the normal "FULL" mark on the oil gage. This level should be marked on the gage for future reference. The presence of a large percentage of gasoline will increase oil consumption and, for that reason, the oil level should be checked fre-

TANK, MEDIUM, M4A3

quently. Use the grade of engine oil prescribed for use between $+32^{\circ}\text{F}$ to 0°F to maintain the oil level to the "FULL" mark on the gage during operation. If the vehicle is operated 4 hours or more at operating temperature, redilution will be necessary if it is anticipated that the vehicle will be left standing unprotected for 5 hours or more. This can be accomplished by adding engine oil prescribed for use between $+32^{\circ}\text{F}$ to 0°F to the "FULL" mark; then adding gasoline to the dilution mark on the gage as described above. If Diesel fuel is used as diluent, drain the crankcase while the engine is still warm and refill, using engine oil prescribed for temperatures between $+32^{\circ}\text{F}$ to 0°F diluted with $9\frac{1}{2}$ quarts of grade X Diesel fuel oil. The presence of a large percentage of Diesel fuel will increase oil consumption and, therefore, the oil level should be checked frequently during operation and maintained to manufacturer's "FULL" mark on gage with engine oil diluted with Diesel fuel as described above. **CAUTION:** *When Diesel fuel is used as a diluent, the quantity of diluent necessary for starting is added when the crankcase is refilled and maintained by the addition of diluted make-up oil. Further additions of diluent prior to overnight shut down are unnecessary.*

(d) If the vehicle is to be kept outdoors, and if the crankcase cannot be drained, shelter the engine compartment with a tarpaulin. About 3 hours before engine is to be started, place fire pots under the tarpaulin. A Van Prag, Primus-type, or other type blowtorch or ordinary kerosene lanterns may be used. With due consideration for the fire hazard involved, the flame may be applied directly to the oil pan below the oil level.

f. Fuel System.

(1) If possible, use a winter grade gasoline. When within continental limits of the United States, a winter grade of gasoline meeting U. S. Army Specification 2-114 must be used. Regardless of the fuel used, a certain amount of condensation from moisture in the air can be expected. At low temperatures the water thus formed will form ice crystals which will clog fuel lines and carburetor jets. To overcome this difficulty, observe the following precautions:

(a) Strain fuel through a chamois skin, or other type of strainer, to prevent passage of water. **WARNING:** *Provide a metallic contact between container and tank to "ground" static electricity.*

(b) Keep fuel storage tanks full at all times if possible. The more fuel there is in a tank, the smaller will be the volume of air from which moisture can condense.

(c) Keep all containers clean and rust free.

(d) If possible, after filling or moving a container, allow fuel to settle before filling vehicle from it.

OPERATION UNDER UNUSUAL CONDITIONS

(1) Keep all containers tight to prevent entrance of snow, ice, dirt, or other foreign matter.

(2) Carburetion trouble suddenly encountered with lowered temperatures may be due to a faulty carburetor. A carburetor which gives no appreciable trouble at normal temperatures may not operate satisfactorily at low temperatures. Replace suspected carburetor.

(3) A fuel pump which delivers enough gasoline for normal starting at 500 revolutions per minute may have leaky valves or a faulty diaphragm. Either would prevent it from delivering sufficient fuel for cold weather starting. Replace suspected fuel pump.

(4) Follow the directions in paragraph 29 d to prepare carburetor air cleaners for cold weather operation.

g. Cooling System.

(1) Only antifreeze compound is prescribed for protection of cooling system during operation below +32°F. Permissible materials and quantities to be used for various temperatures follow:

Temperature	Pints of Antifreeze Compound per Gallon of System Capacity
30°F	1
20°F	1½
10°F	2
0°F	2½
-10°F	3
-20°F	3½
-30°F	4
-40°F	4½
-50°F	5
-60°F	5
-70°F	5

(2) Observe the following precautions before installing anti-freeze solution:

(a) Drain and flush entire cooling system with fresh water (par. 83). Flush radiator and engine separately in order to prevent transfer of residue from one to the other. To accomplish this, disconnect hose connections. Use a flushing gun if available.

(b) Inspect entire system. Replace checked, rotted, or damaged hose and connections. Tighten all connections.

(3) In an emergency, the vehicle can be operated without anti-freeze solution in moderate freezing temperature by partially covering the engine compartment doors. Drain system upon stopping engine, and refill upon starting.

TANK, MEDIUM, M4A3**h. Vehicle Lubrication.**

(1) **TRANSMISSION DIFFERENTIAL AND FINAL DRIVE.** Use SAE 30 engine oil, below +32°F. When temperatures below 0°F are immediately anticipated and transmission, differential and final drive do not contain the specified grade of engine oil, drain immediately after use and while lubricant is still warm. Refill to proper level with SAE 30 engine oil. After standing overnight in sub-zero temperatures, warm up transmission after the engine has been warmed up by engaging clutch and maintaining engine speed for 2 minutes, or until gears can be engaged. Put transmission in low gear and drive vehicle 100 yards, being careful not to stall engine. This will heat up gear lubricants to the point where normal operation can be expected.

(2) **OTHER LUBRICATION POINTS.**

(a) If vehicle has been operated 1000 miles using general purpose grease No. 0, for lubrication, no special precautions are necessary for the bogie wheels and track roller bearings. If general purpose grease No. 1 is in these bearings, it will be necessary to disassemble and wash them in dry-cleaning solvent, dry and then relubricate with general purpose grease No. 0, for satisfactory operation (par. 29 d).

(b) All other places where No. 0 general purpose grease is prescribed for temperatures of +32°F to 0°F shall be lubricated with the same lubricant below 0°F (par. 29 d).

(c) When extremely low temperatures are encountered and No. 0 general purpose grease is not satisfactory where specified above No. 00, O.D. grease, Ordnance Department Tentative Specifications AXS 1169 may be used.

(d) For oilcan points where engine oil is specified above 0°F, use special preservative lubricating oil.

i. Electrical System. Battery efficiency decreases sharply with decreasing temperatures and becomes practically nil at -40°F. To overcome this obstacle, observe the following precautions:

(1) Keep batteries fully charged (hydrometer reading between 1.275 and 1.300) at all times. A fully charged battery will not freeze at temperatures likely to be encountered even in arctic climates, but a fully discharged battery will freeze and break at 5°F.

(2) Do not add water to batteries in subzero weather, unless they are to be charged immediately.

(3) At temperatures of -30°F and below, heat the batteries before trying to start engine with them.

(4) Keep all wiring connections and battery terminals clean and tight.

OPERATION UNDER UNUSUAL CONDITIONS

(5) Check generator and cranking motor brushes, commutator and bearings. Replace brushes if worn. Keep commutator clean. Replace assembly if bearings "drag." If cranking motor fails to engage flywheel, remove cranking motor and clean grease and dirt from throw-out mechanism.

(6) Keep spark plugs clean and check adjustment. Replace spark plugs when gap increases to 0.030 inch (par. 68).

(7) Check timing carefully and adjust, if unduly advanced or retarded (par. 58 c (8)).

(8) Inspect lights carefully for short circuits or presence of moisture around sockets. Perform needed repairs.

(9) Before every start, see that spark plugs, wiring, and other electrical equipment are free from ice.

26. OPERATION UNDER DUSTY, SANDY CONDITIONS, OR UNDERBRUSH.

a. **Operation on Dusty, Sandy Terrain.** In operating the vehicle cross-country on dry, dusty or sandy terrain along with other vehicles, avoid running in the dust cloud of the other vehicles as much as possible. When operating in sand deep enough to force the use of lower gear ratios, do not exceed the speed specified for the particular gear ratios. Even when the above precautions are taken, it may be necessary to clean the carburetor air cleaners and the air cleaner on the filter pipe as often as every two hours. If the air cleaners are kept clean and their oil level is maintained, little damage to the engine will result. It is possible to wear out the engine in one hour or less if the air cleaners are neglected.

b. **Underbrush.** Keep the air intake grilles on the engine compartment bulkhead open and free from all obstructions or covers, particularly if the vehicle is camouflaged.

27. FLOOD OR SUBMERSION.

a. Report to higher authority immediately the flooding or submersion of the vehicle. Dirt and abrasives and particularly salt water will cause serious damage to such units as the engine, clutch, etc. Salt water will damage aluminum parts beyond repair.

TANK, MEDIUM, M4A3

PART THREE—MAINTENANCE INSTRUCTIONS¹

**Section IX
LUBRICATION**

28. LUBRICATION ORDER.

a. War Department Lubrication Order No. 104 (figs. 25 and 26) prescribes lubrication maintenance for M4A3 tanks.

b. A Lubrication Order is placed on or is issued with each vehicle and is to be carried with it at all times. In the event the vehicle is received without a Lubrication Order, the using arm shall immediately requisition a replacement from the Commanding Officer, Fort Wayne Ordnance Depot, Detroit 32, Michigan.

c. Instructions on the Lubrication Order are binding on all echelons of maintenance and there shall be no deviations from these instructions.

d. Service intervals specified on the Lubrication Order are for normal operation conditions. Reduce these intervals under extreme conditions such as excessively high or low temperature, prolonged periods of high speed, continued operation in sand and dust, immersion in water, or exposure to moisture, any one of which may quickly destroy the protective qualities of the lubricant and require servicing in order to prevent malfunctioning or damage to the materiel.

e. Lubricants are prescribed in the "Key" in accordance with three temperature ranges: above +32°F, +32°F to 0°F, and below 0°F. Determine the time to change grades of lubricants by maintaining a close check on operation of the vehicle during the approach to changeover periods. Be particularly observant when starting the engine. Sluggish starting is an indication of thickened lubricants and is also the signal to change to grades prescribed for the next lower temperature range. Ordinarily it will be necessary to change grades of lubricants *only when air temperatures are consistently in the next higher or lower range*, unless malfunctioning occurs sooner due to lubricants being too thin or too heavy.

29. DETAILED LUBRICATION INSTRUCTIONS.

a. Lubrication Equipment.

(1) Each tank is supplied with lubrication equipment adequate to maintain the materiel. Be sure to clean the equipment

LUBRICATION

both before and after use. Operate lubricating guns carefully and in such a manner as to insure a proper distribution of the lubricant. If lubrication fitting valves stick and prevent the entrance of lubricant, remove the fitting and determine cause. Replace broken or damaged lubricators. If lubricator cannot be replaced immediately, cover hole as a temporary expedient with tape to prevent the entrance of dirt. If oil lines become clogged, disassemble the line and remove the obstruction.

(2) Wipe lubricators and surrounding surfaces clean before applying lubricant. Where relief valves are provided, apply new lubricant until the old lubricant is forced from the vent. Exceptions are specified in notes or on the Lubrication Order. Always wipe clean metal surfaces on which a film of lubricant must be maintained by manual application, before the film is renewed.

b. Points of Application.

(1) Lubrication fittings, grease cups, oilers and oil holes are readily identifiable on the vehicle. Wipe clean such lubricators and the surrounding surface before lubricant is applied.

(2) Where relief valves are provided, apply new lubricant until the old lubricant is forced from the vent.

c. **Cleaning.** Use SOLVENT, dry-cleaning, or OIL, fuel, Diesel, to clean or wash all parts. Use of gasoline for this purpose is prohibited. After washing, dry all parts thoroughly before applying lubricant.

d. **Lubrication Notes on Individual Units and Parts.** The following instructions supplement and repeat for clarity those notes on the Lubrication Order which pertain to lubrication and service of individual units and parts.

(1) **AIR CLEANERS.** The instructions regarding air cleaners which appear on WDLO No. 104, 18 March 1944, will be revised in a later edition to agree with the following instructions.

(a) *Oil Bath Type.* Daily, check lever and refill engine air cleaner oil reservoir to bead level with used crankcase oil or OIL, engine, SAE 50 above +32°F, and SAE 30 from +32°F to 0°F. Below 0°F, use OIL, engine, SAE 10. Every 500 miles, daily under extreme dust conditions, remove air cleaners and wash all parts.

(b) *Mesh Type.* Every 50 hours or more often if required, remove auxiliary generator air cleaner, clean and oil filter element with used crankcase oil or OIL, engine, SAE 50 above +32°F,

TANK, MEDIUM, M4A3

WAR DEPARTMENT LUBRICATION ORDER
ORDNANCE DEPARTMENT

No. 104

TANK, MEDIUM, M4A3

SHL G-104.

Per detailed instructions, refer to TM 9-759, TM 9-224.

Lubricate & inspect

inspect & lubricate

NOTE— See Reverse Side for lubrication of SUSPENSION SYSTEM, additional TURRET points, TANK ARMAMENT and additional AGITS

3 Final Drive Drain (1-piece unit) (1-piece unit) Cap. 16 qt. each Chest level
3 Final Drive and Differential Drain (Single unit) Drain and refill (See Gear Case Note) (Located under hull)

Final Drive Fill and Levels (1-piece unit) Cap. 16 qt. each Chest level
Diff. Drain (1-piece unit) Drain and refill (See Gear Case Note) (Located under hull)

Serviced From Driver's Compartment

Three Piece Unit Breather OE 1/2 (See AG Cleaner Note)

Single Unit Breather OE 1/2 (See AG Cleaner Note)

Transmission Drain (3-piece unit and single-unit) Drain and refill (See Note) (Located under hull)

Tachometer Adapter CG 1 (Some models)

Gear Shift Shaft CG 1/2

Parking Brake Lever Shaft CG 1/2 (Some models)

Universal Joint and Slip Joints CG 1 (To reach, remove barrel shield)

Serviced From Turret

Turret Support Bearing CG W (Traverse while lubricating)

Hatch Ring Support Brg. CG W (Some models) (Traverse while lubricating)

Turret Support Bearing CG W (Traverse while lubricating)

Auxiliary Generator Fill (See Note) (Reached from top of hull)

Auxiliary Generator Air Cleaner (See Note)

Serviced From Driver's Compartment

1/2 CG Brake Shaft Bearings

3 CG Speedometer and Tachometer Cables Remove core, clean and coat lightly with No. 0

W OE Trans. Diff. and Final Drives Fill and Level (Single unit) Cap. 152 qt. (round case, 164 qt. sharp nose)

Trans. and Diff. Fill and Level (1-piece unit) Cap. 44 qt. Chest level

1 CG Speedometer Adapter

1/2 OE Parking Brake (Some models)

Serviced From Turret

W CG Turret Traversing Ring

W OH Traversing Gear Box Adapter (On gear models only)

M OG Traversing Gear Box

W CG Turret Support Bearing (Traverse while lubricating)

M OG Traversing Gear Shaft Bearing (Some models)

1 CG Bell Housing Clutch Shaft Bearing (To reach, lift door to turret floor and pick over fitting to remove turret shield)

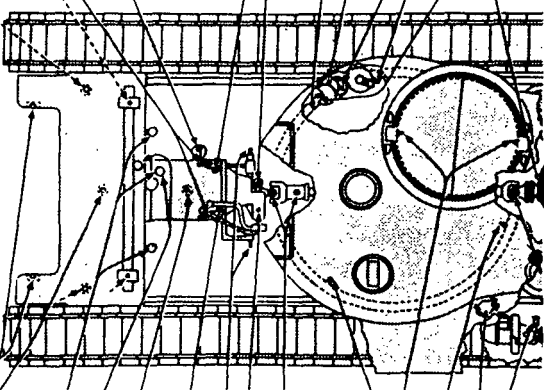
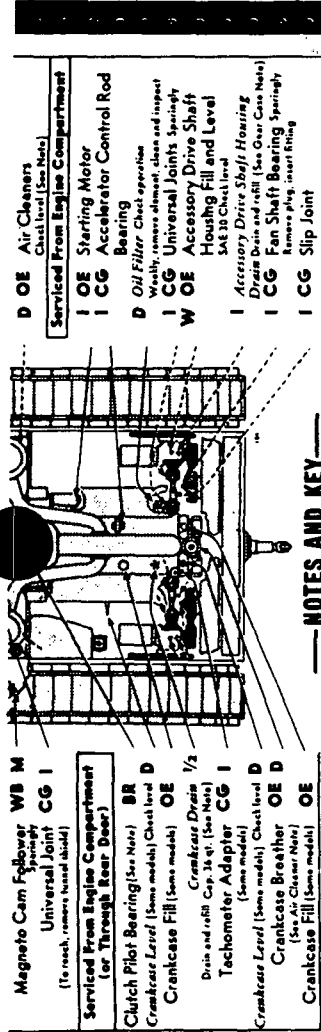

Figure 25—Lubrication—Engine

LUBRICATION

RA PD 3294968



NOTES AND KEY

- Magneto Cam Follower WB M
- Springy (To reach, remove head shield)
- Universal Joint CG I
- Serviced From Engine Compartment (For Through Rear Door)
- Clutch Pilot Bearing (See Note) BR
- Crankcase Level (Some models) Chest level D
- Crankcase Fill (Some models) OE $\frac{1}{2}$
- Drain and refill Cap. 15 qt. (See Note)
- Tachometer Adapter CG I
- (Some models)
- Crankcase Level (Some models) Chest level D
- Crankcase Breather OE D
- (See Closest Note)
- Crankcase Fill (Some models) OE

LUBRICANTS		LOWEST ANTICIPATED AIR TEMPERATURE	ALL TEMPERATURES
OE—Oil engine		above +32°F. to 0°F.	BR—GREASE, ball and roller bearing
Crankcase	SAE 50	+32°F. to 0°F.	OH—OIL, hydraulic
Frost Diff. and Fuel Drives	SAE 30	See OPSB 6-1	RS—OIL, recast, special
Other Points	SAE 50	SAE 30	WB—GREASE, general purpose, No. 2
CG—GREASE, O.D.	SAE 30	SAE 10	PS—OIL, lubricating, preservative, special
CG—GREASE, general purpose	No. 0	No. 00	
	No. 1	No. 0	

No. 104 [NOT TO BE REPRODUCED OR TRANSMITTED IN ANY FORM OR BY ANY MEANS WITHOUT THE WRITTEN PERMISSION OF THE SECRETARY OF THE ARMY]
(For permission of the Chief of Ordnance) CHIEF-CHART

COLD WEATHER: For lubricants and Service below 0°F., refer to TM 9-136, TM 9-757, OPSB 6-11 and OPSB 6-1.

AIR CLEANERS—(Oil Bath Type) Before engine air cleaner with used crankcase oil or OE from 0°F. to -40°F., use OH, below -40°F., remove oil and operate at 1000 rpm. Every 500 miles, disassemble, wash all parts and reassemble with clean oil. For oil bath type, use clean breathing air cleaner, transmittance and differential crankcase grade oil with used crankcase oil or OE. Crankcase grade oil intervals indicated on lubrication chart.—40°F., use OH; below -40°F., use PS.

AUXILIARY GENERATOR—Mix thoroughly $\frac{1}{2}$ pt. of OE SAE 30 with each gallon of gasoline before pouring.

CLUTCH PILOT BEARING—Before relubricating engine after inspection or overhaul, clean and lubricate with BR.

CRANKCASE—Drain only when engine is hot. Every 500 miles or 50 hours, drain and refill. Refill to FULL

mark on gage.—Drain only after operation. Fill through transmission filler to mark on beyond gage with fill cap resting on top of oil pipe. Fill final drives (1-piece unit) with oil to level of dipstick. When dipstick is full, remove oil when hot. Fill accessory drive shaft bearing to FULL mark on beyond gage.

OIL CUP POINTS—Every 350 miles, lubricate packing rings on the following points: Piston Pin, Connecting Rod Pin, Slides, Door and Shield Hinges, Prop Shaft Protrusion, Thrusts and Gear Linkage Ball Joint, Pinion Mating Gear on Drive Shaft, Auxiliary Generator, Clutch Housing, Ring Bolts, Spring Lever Link, Machine Gun Ball Socket and other rubbing parts with OE.

DO NOT LUBRICATE—Water Pump, Regio Wheel Sur-

RELIEF VALVES, Fuel Drive, Special Bearings, Clutch Release Bearing, Axle Bearings, Drive Shaft Bearings, Governor, (Gas Mount) Exhaust Control Arm, Water Pump, Hydraulic Oil Pump, Main Bearings.

SOON TO BE REPLICATED BY ORDNANCE PER-SONNEL. REPLICATED PERIODICALLY BY ORDNANCE PERSONNEL.

CRANKCASE BEARINGS, Elevating Wind (Gas Mount), Elevating Barrel Gear Cases, Turst Traveling Gear Housing, Brake Clutch Spring, Cylinder Assembly (1-1780), Elevating Drive Shaft Housing, Gear Case, Turret Traversing Gear Housing, Bracket Clutch Spring, Cylinder Assembly (1-1780).

Caps of this Lubrication Order will be varied with the material at all times. These lubrication instructions are binding on all orders of maintenance.

By Order of the Secretary of War,
G. C. Marshall, Chief of Staff.

INTERVALS	
D—Daily	$\frac{1}{2}$ —200 miles
W—Weekly	$\frac{1}{2}$ —500 miles
M—Monthly	1—1,000 miles
60—60 hours	2—3,000 miles

10 Mar 44
Supersedes all previous limits.

Hull, and Certain Turret Point.

TANK, MEDIUM, M4A3

No. 104
WAR DEPARTMENT LUBRICATION ORDER
 ORDNANCE DEPARTMENT

TANK, MEDIUM, M4A3

For detailed instructions, refer to TM 9-758, TM 9-324

Requisition replacement Lubrication Orders from the Commanding Officer, Fort Wayne Ordnance Depot, Detroit 32, Michigan.

See Reverse Side for lubrication of ENGINE and DRIVER'S COMPARTMENT, FINAL DRIVE, OIL TYPE and LUBRICATING MECHANISM and SHOT TURRET POINTS.

NOTE

Clean fittings before lubricating. Lubricate after washing.
 Reduce interval under severe operating conditions.
 Lubricate dotted arrow points on both sides. Opposite points are shown by short arrows.

To clean parts use SOLVENT, dry-cleaning or OIL, fuel, Diesel. Dry before lubricating. (See Notes below for cleaning Gun Bore and Machine Gun Bore)

- D, FIG. 27 — Stabilizer Reservoir Level **W**
- E, FIG. 27 — Chest level, keep $\frac{1}{2}$ full (Some models) **OG M**
- F, FIG. 27 — Stabilizer Cylinder **OG M**
- Pivot Pin (Some models) **OG M**
- Stabilizer Piston Rod **OE M**
- Bearing (Some models) **OG M**
- Commanders Traversing Control Cable **OG M**
- Hydraulic Oil Reservoir Fill **OH W**
 Chest level, keep $\frac{1}{2}$ full
- Firing Cable Conduit **OG M**
- **OH** Stabilizer Reservoir Fill (Some models)
- **M OG** Firing Cable Conduit
- **M OG** Commanders Traversing Control Cable
- **D OE** Firing Mechanism
 Only use after firing, clean and oil
- $\frac{1}{4}$ **CG** Tract Support Rollers

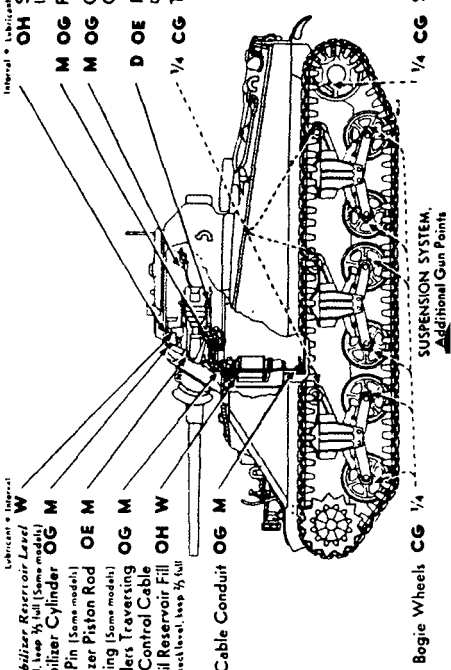

Bogie Wheels **CG** $\frac{1}{4}$ **CG** Suspension System Idler
 SUSPENSION SYSTEM, Additional Gun Points

Figure 26—Lubrication—Turret,

LUBRICATION

HOWITZER, 105-mm, M4
MOUNT, COMBINATION, M52

Lubricant • Interval

D	OE	Gun Bore (See Note)	OE	D
D	PS	Machine Gun Bore (See Note)	OG	M
D	OG	Gun Tube Clean and coat, wipe off excess before firing	PS	D
M	OE	Gyro Control Gear Box	OG	M
W	OG	Periscope Parallel Linkage Control Arm	OE	D
D	OE	Cradle Liner	OG	W
D	OE	Elevating Ract and Pinion Clean and oil	OE	D
M	OG	Firing Cable Conduit	OG	M
D	PS	Elevating Bevel Gear Case (For disassembly, see ORD. Note)	PS	D
D	PS	Machine Gun Breech, Recoil and Firing Mechanism Daily and after firing, clean and oil	RS	D
D	RS	Recoil Mechanism Check daily and before firing Cap. 1/2 pt. 75-mm and 76-mm; 1 1/2 pt. 105-mm, each cylinder.	OE	D
W	OG	Firing Mechanism Daily and after firing, clean and oil	OE	D
D	OE	Breech Closing Spring Chain	OE	D
D	OE	Keyway	OE	D
D	OE	Breech Ejector Cam	OE	D
D	OE	Breech Mechanism Daily and after firing, clean and oil	OG	M

MACHINE GUN BORE—After firing, and for 3 days thereafter, scrub bore with a solution of 1/2 pound SODA ash to each gallon of warm water. Rinse with clear water and dry thoroughly all time daily. Every 3 days, scrub with SOLVENT, dry, cleaning, dry and reoil.

18 Mar 44
Supersedes all previous issues.

See Reverse Side for Additional Notes and Key

No. 104 (NOT TO BE REPRODUCED IN WHOLE OR IN PART) WITH
OUT PERMISSION OF THE OFFICE OF THE CHIEF OF ORDNANCE. CHECK-CHART

GUN 75-mm, M3; 76-mm,
M1A1; M1A2; MOUNT, COMBINATION
GUN, M3A, M33A1; M62

Interval • Lubricant

M, FIG. 28	D	OE	Gun Bore (See Note)	OE	D
I, FIG. 28	D	PS	Machine Gun Bore (See Note)	OG	M
A, FIG. 27	D	OG	Gun Tube Clean and coat, wipe off excess before firing	PS	D
B, FIG. 27	M	OE	Gyro Control Gear Box	OG	M
C, FIG. 27	W	OG	Periscope Parallel Linkage Control Arm	OE	D
G, FIG. 28	D	OE	Cradle Liner	OG	W
	D	OE	Elevating Ract and Pinion Clean and oil	OE	D
	M	OG	Firing Cable Conduit	OG	M
	D	PS	Elevating Bevel Gear Case (For disassembly, see ORD. Note)	PS	D
	D	PS	Machine Gun Breech, Recoil and Firing Mechanism Daily and after firing, clean and oil	RS	D
	D	RS	Recoil Mechanism Check daily and before firing Cap. 1/2 pt. 75-mm and 76-mm; 1 1/2 pt. 105-mm, each cylinder.	OE	D
	W	OG	Firing Mechanism Daily and after firing, clean and oil	OE	D
	D	OE	Breech Closing Spring Chain	OE	D
	D	OE	Keyway	OE	D
	D	OE	Breech Ejector Cam	OE	D
	D	OE	Breech Mechanism Daily and after firing, clean and oil	OG	M

GUN BORE—After firing, and for 3 consecutive days thereafter, scrub bore with a solution of 1/2 pound SODA ash to each gallon of warm water. Rinse with clear water and dry thoroughly all time daily. Every 3 days, scrub with SOLVENT, dry, cleaning, dry and reoil.

18 Mar 44
Supersedes all previous issues.

See Reverse Side for Additional Notes and Key

No. 104 (NOT TO BE REPRODUCED IN WHOLE OR IN PART) WITH
OUT PERMISSION OF THE OFFICE OF THE CHIEF OF ORDNANCE. CHECK-CHART

Tracks, Suspension, and Gun

TANK, MEDIUM, M4A3

and SAE 30 from +32°F to 0°F. Below 0°F, use OIL, engine, SAE 10.

(2) ACCESSORY DRIVE SHAFT HOUSINGS, UNIVERSAL JOINTS AND SLIP JOINTS. Weekly, check level. Filler plug in housing is fitted with bayonet gage; fill to FULL mark on gage. Drain and refill at intervals indicated on Lubrication Order. Lubricate universal joints through fittings with GREASE, general purpose, No. 1, above +32°F, or No. 0 below +32°F. There is no relief valve in these joints; do not use excessive pressure. To lubricate slip joint, apply GREASE, general purpose, No. 1 above +32°F, or No. 0 below +32°F, to fitting until lubricant is forced from end of spline.

(3) AUXILIARY GENERATOR. The two-cycle air-cooled engine mounted on the sponson in left side of fighting compartment, is lubricated with oil mixed with the fuel. Mix thoroughly $\frac{3}{8}$ pint of OIL, engine, SAE 30, with each gallon of gasoline before pouring into tank. CAUTION: *Do not pour gasoline and oil separately into tank.* Keep fuel strainer clean. Monthly, lubricate magneto cam follower sparingly with GREASE, general purpose, No. 2.

(4) BELL HOUSING CLUTCH SHAFT BEARING. To lubricate, open door in turret basket floor and remove plate over fitting or remove tunnel shield to expose fitting.

(5) BREATHER. Every 500 miles, remove filtering medium from transmission and differential breathers, wash thoroughly, dry and recoil with used crankcase oil or OIL, engine, SAE 50 above +32°F, or SAE 30 from +32°F to 0°F. From 0°F to -40°F, use OIL, hydraulic. Below -40°F, wash and replace dry.

(6) BREECH AND FIRING MECHANISM. Daily and before and after firing, clean and oil all moving parts and exposed metal surfaces with OIL, engine, SAE 30 above +32°F, SAE 10 from +32°F to 0°F, or OIL, lubricating, preservative, special, below 0°F. CAUTION: *To insure easy breech operation and to avoid misfiring in cold weather, clean, dry and lubricate with OIL, lubricating, preservative, special.* To clean firing mechanism, remove and operate pin in SOLVENT, dry-cleaning. Use OIL, lubricating, preservative, special, for machine guns.

(7) CLUTCH PILOT BEARING. Before replacing engine after inspection or overhaul, clean and lubricate with GREASE, ball and roller bearing.

(8) CRANKCASE. Daily, check oil level, add oil if necessary. Every 500 miles or 50 hours, drain and refill. Drain only when engine is hot. Refill to FULL mark on gage. CAUTION: *Be sure pressure gage indicates oil is circulating.*

LUBRICATION

(9) **GEAR CASES.** Transmission, differentials and final drive. On some assemblies, the transmission, differential and final drives are combined in one unit. Fill through transmission filler to mark on bayonet gage with fill cap resting on top of fill pipe. Drain through transmission and final drive drain plug holes. Other assemblies use 3-piece units. Fill through transmission filler to mark on bayonet gage with fill cap resting on top of fill pipe, and through each final drive filler to 1 inch below fill plug hole when cold, or to plug level when hot. Drain through transmission, differential and final drive drain plug holes. Weekly, check level with tank on level ground, and if necessary, add lubricant. Every 3,000 miles, drain and refill. Drain only after operation when oil is warm. Refill with OIL, engine, SAE 50 above +32°F, or SAE 30 below +32°F.

(10) **OIL FILTER.** The oil filter is of the self-turning type and is located in the engine crankcase. Daily, check operation of self-turning mechanism. Weekly, remove filter element from housing, clean and inspect.

(11) **OILCAN POINTS.**

(a) Every 250 miles, lubricate parking brake shaft (some models), machine gun mount ball socket, door and shield hinges, step hole protector slides, door latches, lever bushings, control rod pins, throttle and gear linkage ball joints, pintle hook, escape hatch mechanism, seat supports and clevises with OIL, engine, SAE 30 above +32°F; SAE 10 from +32°F to 0°F; OIL, lubricating, preservative, special, below 0°F.

(b) **Gun Mounts.** Weekly, lubricate handwheel handles, firing button, firing lever link, machine gun ball socket and other rubbing parts with OIL, engine, SAE 30 above +32°F; SAE 10 +32°F to 0°F; OIL, lubricating, preservative, special.

(12) **GUN BORE.** After firing, and for 3 consecutive days thereafter, swab bore with a solution of ½ pound SODA, ash, to each gallon of warm water. Rinse with clear water and dry thoroughly before oiling. When gun is not being fired, renew oil film daily. Every 5 days, swab with SOLVENT, dry-cleaning, dry and reoil.

(13) **MACHINE GUN BORE.** After firing, and for 3 consecutive days thereafter, clean with CLEANER, rifle bore, dry and reoil. When machine gun is not being fired, renew oil film daily. Every 5 days, clean with SOLVENT, dry-cleaning, dry and reoil.

(14) **POINTS NOT NEEDING LUBRICATION.** Water pump, bogie wheel suspension linkage, final drive sprocket bearings, clutch re-

TANK, MEDIUM, M4A3

lease bearing, auxiliary generator bearings, engine governor; (Mounts) elevating control arm bearings, hydraulic oil pump motor bearings.

e. Reports and Records.

(1) Report unsatisfactory performance of materiel to the Ordnance Officer responsible for maintenance in accordance with TM 38-250.

(2) A record of lubrication may be maintained in the Duty Roster (W.D., A.G.O. Form No. 6) and in the Artillery Gun Book.

30. POINTS TO BE LUBRICATED BY ORDNANCE PERSONNEL ONLY.

a. Generators. Once each year, remove generators, clean and repack bearings with **GREASE**, ball and roller bearing.

b. Engine Magnetos. At time of inspection or general overhaul, clean and repack bearings with **GREASE**, ball and roller bearing. Lubricate cam wick with 1 or 2 drops of **OIL**, engine, **SAE 10**.

c. Cradle Trunnion Bearings. Every 6 months, disassemble trunnions, clean and lubricate with **GREASE**, general purpose No. 2.

d. Elevating Worm Gear Case (75-mm and 76-mm only). Every 6 months, disassemble gear case, wash all parts, fill case $\frac{2}{3}$ full with **GREASE**, O.D., No. 0 above +32°F, or No. 00 below +32°F, and reassemble.

e. Elevating Bevel Gear Cases; Elevating Worm Gear Case (105-mm only). Every 6 months, disassemble case, wash all parts and lubricate gears and bearings with **GREASE**, O.D., No. 0 above +32°F, or No. 00 below +32°F.

f. Turret Traversing Gear Housing. Every 6 months, disassemble, clean and repack gears with **GREASE**, O.D., No. 0 above +32°F, or No. 00 below +32°F.

g. Breech Closing Spring Cylinder Assembly (75-mm and 76-mm only). Every 6 months, or whenever the breech block is disassembled, disassemble the breech block closing spring cylinder assembly, clean and coat the inside and breech ring end of the closing spring cylinder assembly with **GREASE**, O.D., No. 0 above +32°F, and No. 00 below +32°F.

LUBRICATION

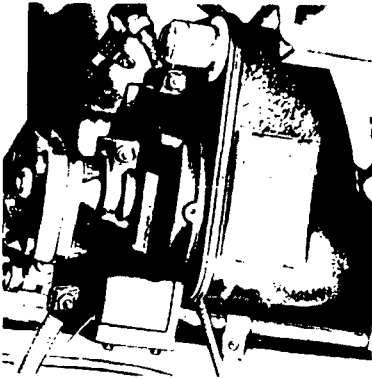

A STABILIZER GEAR BOX—OE
ONE FITTING

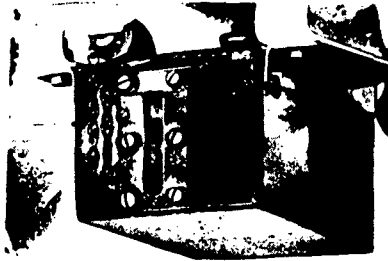

D STABILIZER OIL RESERVOIR—OH
CHECK LEVEL—KEEP $\frac{3}{4}$ FULL

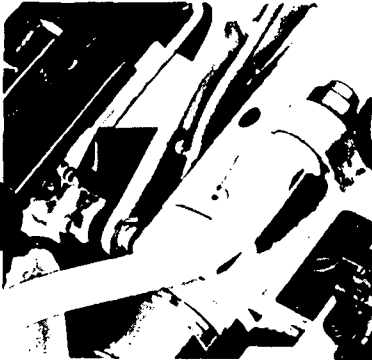

B RECOIL MECHANISM—RS
2 PLUGS, ONE FOR EACH CYLINDER
FILL TO BOTTOM OF HOLE
WITH GUN DEPRESSED 5 DEGREES

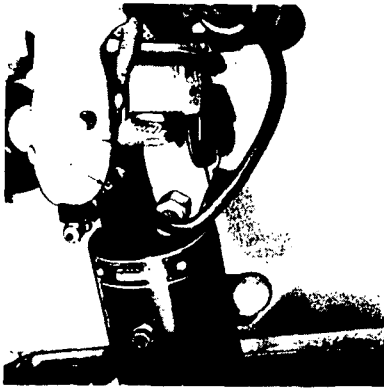

E STABILIZER CYLINDER PIVOT PIN—OG

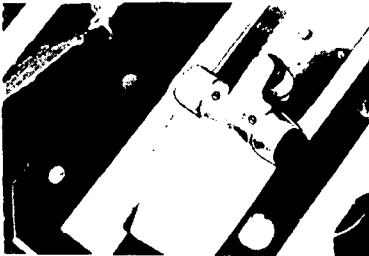

C BREECH MECHANISM—OE OIL DAILY



F STABILIZER PISTON ROD BEARING—OE

RA PD 337123

**Figure 27—Localized Views of Armament Lubrication Points
(75-mm and 76-mm Guns)**

TANK, MEDIUM, M4A3

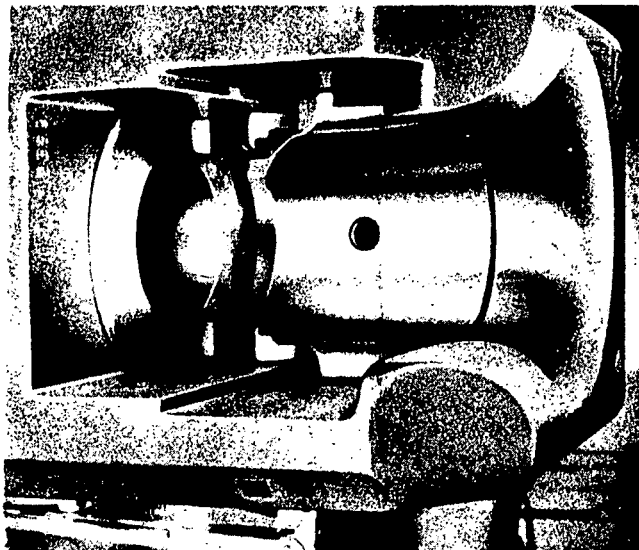

G BREECH MECHANISM—OE
CLEAN AND OIL



H ELEVATING BEVEL GEAR CASE—OG
USE PRESSURE GUN

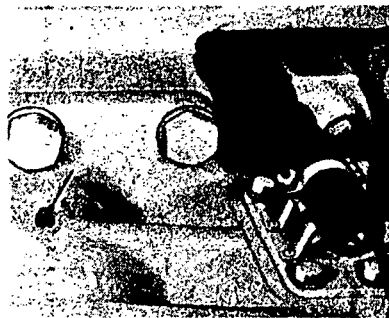

I CRADLE LINER—OG
ONE FITTING. USE PRESSURE GUN

RA PD 337124

Figure 28—Localized Views of Armament Lubrication Points
(75-mm and 76-mm Guns)

LUBRICATION

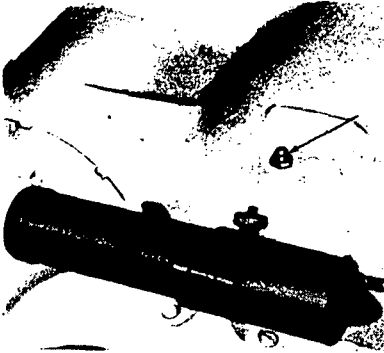

A CRADLE LINER—OG
ONE FITTING. USE PRESSURE GUN

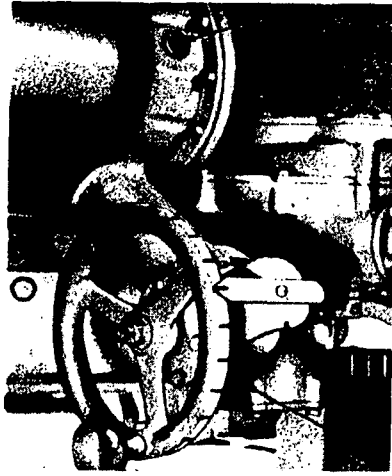

C ELEVATING MECHANISM—OG
TWO FITTINGS. USE PRESSURE GUN

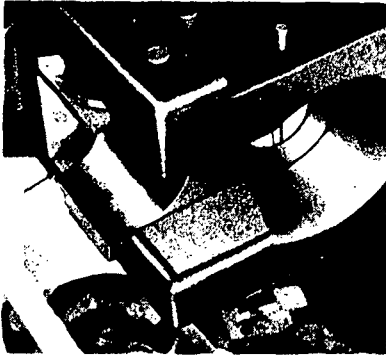

B BREECH MECHANISM—OE
CLEAN AND OIL

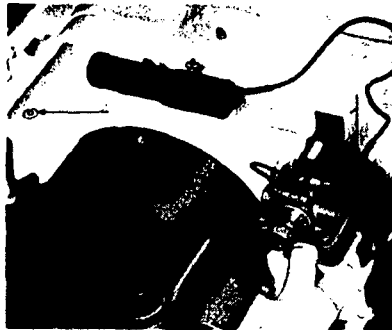

D RECOIL MECHANISM—RS
2 PLUGS, ONE FOR EACH CYLINDER.
REMOVE PLUGS—FILL UP TO BOTTOM
OF HOLE WITH GUN DEPRESSED
5 DEGREES

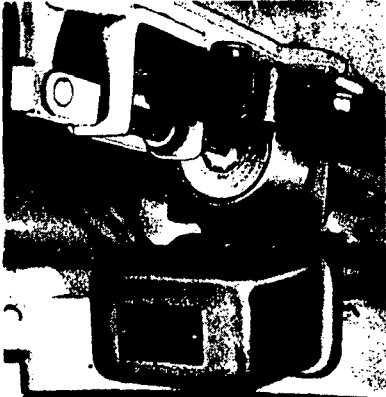

E FIRING MECHANISM—OE
CLEAN AND OIL

RA PD 337125

Figure 29—Localized Views of Armament Lubrication Points (105-mm Howitzer)

TANK, MEDIUM, M4A3

Section X

NEW VEHICLE RUN-IN TEST

31. PURPOSE.

a. When a new or reconditioned vehicle is first received at the using organization, it is necessary for second echelon personnel to determine whether or not the vehicle will operate satisfactorily when placed in service. For this purpose, inspect all accessories, sub-assemblies, assemblies, tools, and equipment to see that they are in place and correctly adjusted. In addition, they will perform a run-in test of at least 50 miles as directed in AR 850-15, paragraph 25, table III, according to procedures in paragraph 33 below.

32. CORRECTION OF DEFICIENCIES.

a. Deficiencies disclosed during the course of the run-in test will be treated as follows:

(1) Correct any deficiencies within the scope of the maintenance echelon of the using organization before the vehicle is placed in service.

(2) Refer deficiencies beyond the scope of the maintenance echelon of the using organization to a higher echelon for correction.

(3) Bring deficiencies of serious nature to the attention of the supplying organization.

33. RUN-IN TEST PROCEDURES.

a. **Preliminary Service.**

(1) **FIRE EXTINGUISHERS.** See that portable and fixed system cylinders are fully charged, securely stowed, and inspect the operating valves. If valves appear to have been opened or are damaged, report to proper authority for exchange or refill. Examine lines and controls of fixed system to see if they are in good condition and that nozzles are properly aimed and not clogged.

(2) **FUEL, OIL, AND WATER.** Fill main and auxiliary fuel tank, also see that engine oil is at the proper level. **CAUTION:** *Mix $\frac{3}{8}$ pint SAE No. 30 engine oil with each gallon of gas to be used in Homelite engine unit.* If there is a tag attached to engine oil tank filler cap concerning contents, follow the instructions on the tag before starting the engine when item 21 is reached. Check coolant level at water level petcock (fig. 41) and replenish as needed. During period when antifreeze is used, have value of antifreeze checked and add as needed.

NEW VEHICLE RUN-IN TEST

(3) **FUEL FILTER, ON HOMELITE AUXILIARY GENERATOR UNIT ONLY.** Remove plug and allow water and sediment to drain out. If any appreciable amount of water is present, remove bowl, wash bowl and screen in cleaning solvent and reassemble. Wash the carburetor air cleaner screen and replace.

(4) **BATTERIES.** Make hydrometer test, and add clean water to $\frac{1}{2}$ inch above the plates if needed. Inspect terminal connections and bolts, to be sure they are clean and secure. On vehicles so equipped, read voltmeter to see that normal voltage is indicated.

(5) **AIR CLEANERS AND BREATHER CAP.** Examine carburetor and auxiliary generator air cleaners and crankcase ventilator breather cap, to see if they are in good condition and secure. Remove elements and wash in dry-cleaning solvent. Fill reservoirs to correct level with fresh or clean used engine oil and reinstall securely. Make sure all gaskets are in good condition, and that ducts and air horn connections are tight.

(6) **ACCESSORIES AND BELTS.** See that all accessories, such as carburetors, main and auxiliary generators, regulators, cranking motor, water pump, fans, radiator cores and oil coolers are in good condition, clean and secure. Inspect fan and generator drive belts for good condition and that they are adjusted to have $\frac{1}{2}$ to $\frac{3}{4}$ -inch finger-pressure deflection. Inspect fan accessory drive shafts and universal joints for looseness and damage. Test auxiliary generator to see that it operates properly.

(7) **ELECTRIC WIRING.** Examine all accessible wiring and conduits to see if they are in good condition, securely connected, shielded and supported.

(8) **TRACKS.** Clean all foreign material from tracks and suspension units. Examine track blocks for damage, loose wedges, nuts or connectors. See that tracks are correctly assembled and adjusted. Vehicles equipped with vertical volute springs should not have more than $\frac{3}{4}$ -inch sag at inspection hole in sand shield. Vehicles equipped with horizontal volute springs should not have any sag between the drive sprockets and the forward suspension wheels, and between the idler wheels and the rear suspension wheels. Be sure spare blocks are present and securely mounted or stowed.

(9) **BOGIE ASSEMBLY AND FLANGE NUTS.** See that sprocket, idler, bogie wheel and support roller, assembly, mounting and flange nuts are present and secure.

(10) **FENDERS AND SAND SHIELDS.** Examine fenders, sand shields, lamp and brush guards for good condition and secure mounting.

TANK, MEDIUM, M4A3

(11) **TOWING CONNECTIONS.** Inspect pintle hook, cables and all connections for good condition and proper operation of latch and lock.

(12) **HULL, TARPAULIN AND CAMOUFLAGE NET.** See that all hull attachments, hardware, lift loops, doors, hatches, their releases and locking mechanism are in good condition, secure and operating properly. See that tarpaulin or camouflage net is in good condition and properly stowed. **CAUTION:** *Do not fully release bottom escape hatch latch during operation.* See that hull drains open and close freely, that there are no bright spots on hull to cause glare or rust, and be sure markings are legible.

(13) **VISION DEVICES.** Inspect periscope prisms and windows, mounted or spares, to see that they are in good condition and clean. See that mounted units are secure in holders, and that holders are properly mounted. Test each periscope to see that it will elevate, traverse and depress through full range. **CAUTION:** *Clean periscopes and windows only with a soft cloth or brush.*

(14) **LUBRICATE.** Perform a complete lubrication of the vehicle, covering all intervals according to instructions on Lubrication Order, paragraph 28, except gear cases, and units lubricated or serviced in item (1) to (13). Check all gear case oil levels, and add oil as necessary to bring to correct levels. Change only if condition of oil indicates the necessity, or if oil is not of proper grade for existing atmospheric temperature. **NOTE:** *Perform items (15) to (17) during lubrication.*

(15) **VOLUTE SPRINGS AND SUSPENSION.** Inspect all suspension brackets, arms, springs, links and guides to see if they are in good condition, correctly assembled, secure, and not leaking excessively at seals. Inspect rollers and suspension wheel tires for damage or separation from wheels. On vehicles so equipped, see that shock absorbers are not excessively worn and not leaking.

(16) **STEERING LINKAGE.** Inspect all shafts, arms, rods, connections, levers and grips to see that they are in good condition, correctly assembled and adjusted. Check released position of steering levers. Levers are correctly positioned when horizontal distance from face of brake drum housing cover to front edge of lever is 7 to 7½ inches.

(17) **PROPELLER SHAFT AND UNIVERSAL JOINTS.** Inspect propeller shaft and universal joints to see that they are properly aligned, securely mounted and not leaking excessively at seals.

(18) **VENTS.** Examine breathers in transmission and final drives to be sure they are in good condition, secure and not clogged.

NEW VEHICLE RUN-IN TEST

(19) **PRIMER.** As engine is being started in item 20, observe if primer action is satisfactory, and look for fuel leaks at primer pump and connections.

(20) **ENGINE WARM-UP.** Operate primer, if necessary, and start engine, observing if cranking motor has satisfactory speed, and if it engages and disengages properly without unusual noise. Set hand throttle to run engine at a fast idle. Start and test Homelite auxiliary generator engine to see if it operates properly.

(21) **INSTRUMENTS.**

(a) *Oil Pressure Gage.* Normal oil pressure idling (500 revolutions per minute) is 30 pounds minimum; at operating speed, 60 to 110 pounds. Stop engine if minimum oil pressure is not indicated in 30 seconds after starting engine.

(b) *Ammeter.* After starting, ammeter may show high charging rate until current used in starting is restored to batteries. When batteries are fully charged and lights and electrical accessories turned off, the ammeter will remain at zero.

(c) *Engine Temperature Gage.* Reading should rise gradually during warm-up period to about 90°F above atmospheric temperature. Highest safe operating temperature is 235°F. **CAUTION:** *Do not move vehicle until a temperature of 100°F is indicated.*

(d) *High Water Temperature and Low Oil Pressure Signal.* Signal light or lights will come on if oil pressure is low (below 8 pounds), or if water temperature exceeds 235°F.

(e) *Tachometer.* Tachometer should register engine speed in revolutions per minute, and record accumulating revolutions.

(f) *Fuel Gage.* Operate selector switch; gage should indicate approximate amount of fuel in each main tank. Ordinarily tanks will have been filled and gage should register **FULL**.

(g) *Transmission Oil Temperature Gage.* On vehicles so equipped, gage should indicate temperature of transmission oil. Under normal operation, temperature should not exceed 200°F.

(h) *Oil Level Gage.* On vehicle so equipped, gage should indicate level of oil in engine oil pan sump.

(i) *Clock.* On vehicles so equipped, clock should be wound and set correctly.

(j) *Voltmeter.* On vehicles so equipped, voltmeter should indicate voltage of batteries approximately 24 volts when master switch is on.

(22) **ENGINE CONTROLS.** Observe whether engine responds to hand throttle and accelerator promptly and properly, and if there is excessive looseness or binding in controls.

(23) **HORN AND WINDSHIELD WIPERS.** Test horn for tone and operation and when windshield wipers are in use, operate to see that blades press windshield firmly through full stroke.

TANK, MEDIUM, M4A3

(24) **LAMPS (LIGHTS).** Observe whether all lamps including blackout and stop lights respond to the switches in both the OFF and ON positions.

(25) **LEAKS, GENERAL.** Examine in engine, driver's and fighting compartments and under vehicle for fuel, oil, and water leaks.

(26) **TOOLS AND EQUIPMENT.** Check tools and On Vehicle Stowage List (paragraphs 6 through 11), to be sure all items are present, and see that they are serviceable and properly mounted or stowed.

b. Run-in Test. Perform the following procedures (1) to (11) inclusive during the road test of the vehicle. On vehicles which have been driven 50 miles or more in the course of the delivery from the supply to the using organization, reduce the length of the road test to the least mileage necessary to make observation listed below. **CAUTION:** *Continuous operation of the engine at speeds approaching the maximum indicated on the caution plate should be avoided during the test.*

(1) **DASH INSTRUMENTS AND GAGES.** Do not move vehicle until engine temperature is above 100° F. Observe readings of oil pressure gage, ammeter, fuel gage, and tachometer, and on vehicles so equipped, voltmeter, oil level gage and transmission temperature gage, to see if they register the proper function of the units to which they apply. With the vehicle in motion, the speedometer should register vehicle speed, and the odometer register accumulating mileage.

(2) **BRAKES (STEERING AND PARKING).** Pull back on both steering brake levers and observe whether they stop the vehicle effectively and meet resistance slightly before the vertical position. With vehicle on an incline, apply the parking brakes and observe whether they hold the vehicle securely and the levers will lock securely in the applied position. Apply the steering brakes independently, and notice whether they steer the vehicle properly.

(3) **CLUTCH.** Clutch must not drag, and should engage without unusual noise, grab or chatter. Test clutch for slippage under full load. Pedal-free travel must be maintained at $2\frac{7}{8}$ inches on vehicles equipped with a clutch booster, and at 3 inches when a clutch booster is not provided. Inspect clutch booster linkage, spring and connections, to see that they are correctly assembled and operate properly. **CAUTION:** *Do not ride clutch pedal, and do not engage or disengage new clutch severely until clutch plates have become properly worn in.*

(4) **TRANSMISSION.** Gearshift mechanism should operate easily without unusual noise and not slip out of mesh during operation.

NEW VEHICLE RUN-IN TEST

(5) **ENGINE.** The engine must respond to controls and have a maximum pulling power without unusual noise, stalling, overheating or exhaust smoke.

(6) **UNUSUAL NOISES.** Be on the alert continually for unusual noises that would indicate looseness of tracks, bogies, sprockets or idler wheels.

(7) Halt vehicle at 10-mile intervals or less for services (8) and (9) below.

(8) **TEMPERATURES.** Place hand cautiously on each track wheel and track support roller hub to see whether they are abnormally hot. If wheel hubs are too hot to touch with the hand, bearings may be inadequately lubricated, damaged or improperly adjusted. Check transmission and final drives for overheating or excessive oil leaks. On vehicles equipped with horizontal volute springs, shock absorbers should feel warm while vehicle is being operated.

(9) **LEAKS.** Inspect within engine, driver's and fighting compartments, also under vehicle for fuel, oil, and water leaks. Trace all leaks to their source and correct or report same.

(10) **GUN ELEVATING AND TRAVERSING MECHANISM.** Place vehicle on a 10-degree lateral incline (tilted sideways). Traverse the turret through its full 360-degree range by both the hand and power controls, and observe whether there is any indication of binding. With the gun pointed forward or rearward, elevate it through its entire range with the hand controls to see if there is any binding, excessive lash or erratic action.

(11) **TRACK TENSION.** Recheck track tension to see if it is within specified limits. On vehicles equipped with vertical volute springs, track should have $\frac{1}{2}$ to $\frac{3}{4}$ -inch sag between center and rear roller at inspection window in sand shield. On vehicles equipped with horizontal volute springs there should be no sag between the drive sprockets and forward suspension wheels, and between the idler wheels and the rear suspension wheels. Be sure adjustment locking devices are secure.

c. Vehicle Publication and Reports.

(1) **PUBLICATIONS.** See that the vehicle Operator's Manual, Lubrication Order, Standard Form No. 26 (Driver's Report—Accident, Motor Transportation), and W.D., A.G.O. Form No. 478 (MWO and Major Unit Assembly Replacement Record), are in the vehicle, legible, and properly stowed. *NOTE: U.S.A. registration number and vehicle nomenclature must be filled in on Form No. 478, for new vehicles.*

(2) **REPORTS.** Upon completion of the run-in test, correct or report any deficiencies noted. Report general condition of the vehicle to designated individual in authority.

TANK, MEDIUM, M4A3

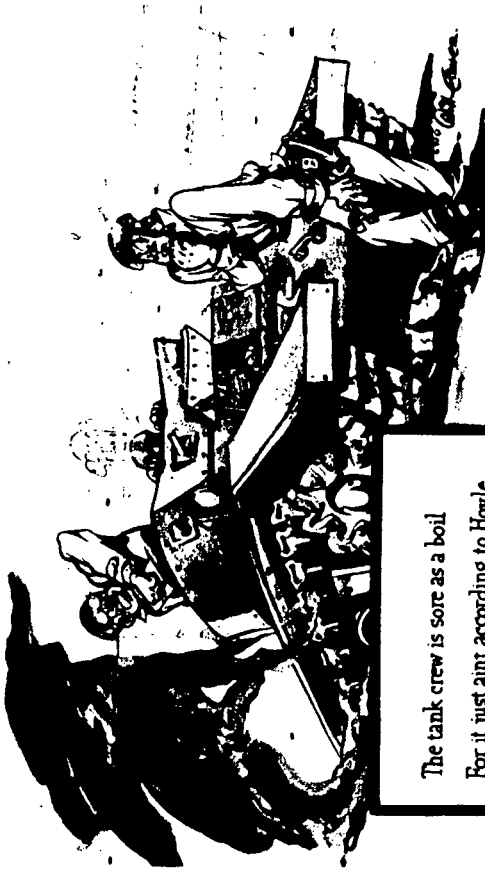

The tank crew is sore as a boil
For it just aint according to Hoyle
To get caught in a spot
So exceedingly hot —
Joe Dope had checked all...but the oil!

Don't be a dope!
**HANDLE
EQUIPMENT RIGHT!**

Section XI

FIRST ECHELON PREVENTIVE MAINTENANCE SERVICE**34. PURPOSE.**

a. To insure mechanical efficiency it is necessary that the vehicle be systematically inspected at intervals each day it is operated, and weekly, so defects may be discovered and corrected before they result in serious damage or failure. Certain scheduled maintenance services will be performed at these designated intervals. The services set forth in this section are those performed by the driver or crew before-operation, during-operation, at-halt and after-operation, also weekly.

b. Driver preventive maintenance services are listed on the back of "Driver's Trip Ticket and Preventive Maintenance Service Record" W.D., Form No. 48, to cover vehicles of all types and models. Items peculiar to specific vehicles, but not listed on W.D., Form No. 48, are covered in manual procedures under the items with which they are related. Certain items listed on the form that do not pertain to the vehicle involved are eliminated from the procedures as written into the manual. Every organization must thoroughly school each driver in performing the maintenance procedure set forth in manuals, whether or not they are listed specifically on W.D., Form No. 48.

c. The items listed on W.D., Form No. 48, that apply to this vehicle are expanded in this manual to provide specific procedures for accomplishment of the inspections and services. These services are arranged to facilitate inspection and conserve the time of the driver, and are not necessarily in the same numerical order as shown on W.D., Form No. 48. The item numbers, however, are identical with those shown on that form.

d. The general inspection of each item applies also to any supporting member or connection, and generally include a check to see whether the item is in good condition, correctly assembled, secure, or excessively worn.

e. The inspection for "good condition" is usually an external visual inspection to determine whether the unit is damaged beyond safe or serviceable limits. The term good condition is explained further by the following: Not bent or twisted, not chafed or burned, not broken or cracked, not bare or frayed, not dented or collapsed, not torn or cut, not deteriorated.

f. The inspection of a unit to see that it is "correctly assembled" usually an external visual inspection to see whether it is in its normal assembled position in the vehicle.

TANK, MEDIUM, M4A3

g. The inspection of a unit to determine if it is "secure" is usually an external visual examination, a wrench, hand-feel, or a pry-bar check for looseness. Such an inspection should include any brackets, lock washers, lock nuts, locking wires, or cotter pins used in assembly.

h. "Excessively worn" will be understood to mean worn close to, or beyond serviceable limits, and likely to result in a failure if not replaced before the next scheduled inspection.

i. Any defects or unsatisfactory operating characteristics beyond the scope of first echelon to correct must be reported at the earliest opportunity to the designated individual in authority.

35. BEFORE-OPERATION SERVICE.

a. This inspection schedule is designed primarily as a check to see that the vehicle has not been damaged, tampered with, or sabotaged since the "After-operation Service" was performed. Various combat conditions may have rendered the vehicle unsafe for operation, and it is the duty of the driver to determine whether or not the vehicle is in condition to carry out any mission to which it is assigned. This operation will not be entirely omitted, even in extreme tactical situations.

b. **Procedures.** Before-operation Service consists of inspecting items listed below according to the procedure described, and correcting or reporting any deficiencies. Upon completion of the service, results should be reported promptly to the designated individual in authority.

(1) **ITEM 1, TAMPERING AND DAMAGE.** Examine entire vehicle, armament and special equipment for injury caused by tampering, sabotage, collision, falling debris or shell fire, since parking. Look within engine compartment for evidence of these conditions, and for loose or damaged engine accessories or drive belts, loose fuel, oil or coolant lines or disconnected control linkage. If wet, dry ignition parts.

(2) **ITEM 2, FIRE EXTINGUISHERS.** Examine visible fixed extinguisher lines and nozzles in engine compartment for security, damage, and correct aiming. Check portable and fixed extinguisher cylinders for good condition, security and full charge. See that nozzles are not clogged.

(3) **ITEM 3, FUEL, OIL AND WATER.** Check supply of fuel, oil and coolant, and add as necessary to bring to proper levels. **NOTE:** Investigate, correct, or report any unusual drop in level since After-operation Service. During freezing weather when and

FIRST ECHELON PREVENTIVE MAINTENANCE SERVICE

Antifreeze solution is in use, if an appreciable addition of water is needed, have antifreeze value checked and added as necessary to protect cooling system against freezing.

(4) **ITEM 4, ACCESSORIES AND DRIVES.** Inspect accessible accessories such as carburetor, generator, magnetos, fans, fan shrouds, air cleaners and Homelite heater-generator unit, and its accessories for good condition and secure mounting. Be sure that fan and generator belts have $\frac{1}{2}$ to $\frac{3}{4}$ -inch deflection under finger pressure, halfway between pulleys.

(5) **ITEM 6, LEAKS.** Check under vehicle, in fighting and engine compartment, for fuel, oil or coolant leaks. Inspect engine oil pan, filters, oil cooler, oil lines, radiator and water hose for leaks. Trace any leaks to their source and correct or report them.

(6) **ITEM 8, PRIMER.** While starting engine, in item 7, observe if primer functions satisfactorily and inspect for loose lines or brackets and traces of leaks.

(7) **ITEM 7, ENGINE WARM-UP.** Start engine and note if action of starting motor is satisfactory, particularly whether it has adequate cranking speed, and engages and disengages without unusual noise. **CAUTION:** *If oil pressure gage does not indicate satisfactory pressure immediately, engine should be stopped and trouble corrected or reported.* Allow engine to run at idling speed 800 to 1000 revolutions per minute during warm-up period, and proceed with the following Before-operation Services.

(8) **ITEM 9, INSTRUMENTS.**

(a) *Oil Pressure Gage and "Low Oil" Light.* Oil pressure gage should register 60 to 110 pounds at 2600 revolutions per minute. Stop engine and investigate if "Low Oil" light comes on.

(b) *Ammeter.* The ammeter may show high charge until the generator has restored to battery the current used in starting the engine; it will continue to register slight charge or zero with lights and accessories turned off if battery is fully charged. Any unusual drop or rise in readings should be investigated.

(c) *Tachometer.* Tachometer should register engine revolutions per minute and revolution counter should register accumulating revolutions.

(d) *Engine Temperature Gage.* Reading should be approximately 90°F above atmospheric temperature. "Water Temp" light or lights come on at maximum operating temperature, 235°F. **CAUTION:** *Vehicle should not be moved until temperature is above 100°F.*

(e) *Fuel Gage.* Fuel gage should register amount of fuel in tanks. Use selector switch to check amount in each tank. Normally, tanks should be full before operation and gage should register "FULL."

TANK, MEDIUM, M4A3

(f) *Transmission Oil Temperature Gage.* On vehicles so equipped, gage should indicate transmission oil temperature; under normal operation, temperature should not exceed 200°F.

(g) *Voltmeter.* On vehicles so equipped, when master switch is on, the voltmeter should indicate battery voltage approximately 24 volts but not to exceed 30 volts.

(h) *Clock.* On vehicles so equipped, clock should be wound and set correctly.

(i) *Oil Level Gage.* On vehicles so equipped, gage should indicate amount of oil in engine oil pan sump.

(9) **ITEM 10, HORN AND WINDSHIELD WIPER.** If tactical situation permits, test horn for proper operation and tone. When used, inspect wipers, blades and arms to see that they are in good condition and secure. Start wiper motors and observe if blades operate through their full stroke and contact windshield surface evenly.

(10) **ITEM 11, GLASS.** Clean all vision device glass and inspect for damage.

(11) **ITEM 12, LIGHTS.** Clean all lights and examine for looseness and damage. If tactical situation permits, operate all switches and observe if lamps respond satisfactorily.

(12) **ITEM 13, WHEEL AND FLANGE NUTS.** See that all drive sprocket, idler wheel, bogie wheel, and support roller assembly and mounting nuts are present and secure.

(13) **ITEM 14, TRACKS.** Inspect tracks for damage, loose connectors, wedge nuts or lock pins. Track tension, on vehicles equipped with vertical volute springs, should allow $\frac{1}{2}$ to $\frac{3}{4}$ inch sag half-way between center and rear support wheels at inspection openings in sand shields. On vehicles equipped with horizontal volute springs, there should be no sag between the drive sprockets and forward suspension wheels and between the idler wheels and the rear suspension wheels.

(14) **ITEM 15, SPRINGS AND SUSPENSIONS.** Inspect volute springs, arms and all bogie suspension units to see that they are in good condition and securely mounted. On vehicles equipped with horizontal volute springs and shock absorbers, see that shock absorbers are secure and not leaking.

(15) **ITEM 16, STEERING LINKAGE.** Inspect all steering brake lever linkage to see that it is in condition for safe operation. Check released position of steering levers. Levers are correctly positioned when the horizontal distance from face of brake drum housing cover to front edge of lever is 7 to 7½ inches. Pull back on both steering levers, observe whether they both meet firm resistance just before

FIRST ECHELON PREVENTIVE MAINTENANCE SERVICE

holding a vertical position and remain in applied position with lever locking device on.

(16) **ITEM 17, FENDERS AND SAND SHIELDS.** Inspect to see that fenders are in good condition and secure. When equipped with sand shields, see that they are securely mounted, not damaged, and do not interfere with tracks.

(17) **ITEM 18, TOWING CONNECTIONS.** See that tow loops are in good condition and securely shackled. Examine pintle hook for good condition and proper operation of latch and lock.

(18) **ITEM 19, HULL AND TARPAULIN OR CAMOUFLAGE NET.** Inspect doors, deck hatches, bottom escape hatch and hull to be sure these items are in good condition. See that doors and hatches open and close properly and that all locks work freely. **CAUTION: Do not fully open bottom escape hatch latch during this inspection.** Inspect tarpaulin or camouflage net for good condition and proper stowage.

(19) **ITEM 20, DECONTAMINATOR.** Examine decontaminator for secure mounting and closed valve. Remove filler plug and see that it is fully charged.

(20) **ITEM 21, TOOLS AND EQUIPMENT.** Check tools and equipment to see that all items are present, in good condition, and properly mounted or stowed.

(21) **ITEM 22, ENGINE OPERATION.** Engine should idle smoothly between 500 and 800 revolutions per minute. Accelerate engine several times momentarily and note any unusual noises, unsatisfactory operating characteristics, vibrations or excessive smoke.

(22) **ITEM 23, DRIVER'S PERMIT AND FORM NO. 26.** Driver must have Operator's permit on his person. Accident-Report Form No 26, vehicle manual, Lubrication Order and W.D., A.G.O. Form No. 478 must be present, legible and safely stowed.

(23) **ITEM 25, DURING-OPERATION CHECK.** The During-operation inspections and observations should start immediately after the vehicle is put in motion, in the nature of a road test.

36. DURING-OPERATION SERVICE.

a. While vehicle is in motion, listen for any sounds, such as rattles, knocks, squeals or hums, that may indicate trouble. Look for indications of trouble in cooling system and for smoke from any part of the vehicle. Be on the alert to detect any odor of overheated components or units such as generator or clutch, fuel vapor from a leak in fuel system, exhaust gas or other signs of trouble. Any time the brakes are used, gears shifted or vehicle turned, consider this a check and notice any unsatisfactory or unusual performance. Notice

TANK, MEDIUM, M4A3

promptly any unusually different instrument indications that may signify possible trouble in the system to which the instrument applies.

h. Procedures. During-operation Services consist of observing items listed below according to the procedures following each item and investigating any indications of serious trouble. Notice minor deficiencies to be corrected or reported at earliest opportunity, usually at the next scheduled halt.

(1) **ITEM 26, STEERING BRAKES.** With vehicle in motion, apply each brake independently, and observe if there is normal response without excessive pull or lever travel. Disengage clutch, apply both levers, and observe if brakes stop vehicle effectively, meeting resistance slightly before vertical position. Stop vehicle on a reasonable incline and apply parking brake lock to see if brakes hold satisfactorily and lock holds levers securely in the applied position.

(2) **ITEM 28, CLUTCH.** Clutch release mechanism should operate freely without excessive noise. Clutch should not grab, chatter or squeal upon engagement and should not slip under load when fully engaged. Pedal free travel should be maintained at $2\frac{7}{8}$ inches on vehicles that are equipped with clutch booster and at approximately 3 inches if not equipped with a clutch booster.

(3) **ITEM 29, TRANSMISSION.** Transmission should shift into all gear ranges easily without unusual noise and should not slip out of mesh during operation.

(4) **ITEM 31, ENGINE AND CONTROLS.** Driver should be on the alert for deficiencies in engine performance such as lack of power and acceleration, misfiring, backfiring, unusual noise, or indication of overheating or excessive smoke. Observe whether or not engine accelerates satisfactorily and controls operate without excessive looseness or binding. If radio noise during operation of vehicle is reported, driver will cooperate with radio operator in locating the interference (par. 54).

(5) **ITEM 32, INSTRUMENTS.** Observe the readings of all pertinent instruments frequently during operation, to see whether they are indicating proper function of units to which they apply, and that speedometer registers vehicle speed and odometer records accumulating mileage.

(6) **ITEM 34, RUNNING GEAR.** Listen for any unusual noise from tracks, wheels, and rollers.

(7) **ITEM 36, GUNS (MOUNTINGS, ELEVATING, TRAVERSING, FIRING CONTROLS AND STABILIZER).** While the vehicle is in motion but before guns are used in combat, test both manual and hydraulic controls to be sure that all mechanisms respond satisfactorily and that all mountings are secure. Test stabilizer action by pressing gun

FIRST ECHELON PREVENTIVE MAINTENANCE SERVICE

Check to see that gun returns to aimed position without "hunting." Adjust stiffness control, as necessary. NOTE: *Recoil tests and adjustments must be made while firing.*

37. AT-HALT SERVICE.

a. At-halt Services may be regarded as minimum maintenance procedures and should be performed under all tactical conditions, even though more extensive maintenance services must be slighted or omitted altogether

b. **Procedures.** At-halt Services consist of investigating any deficiencies noted during operation, inspecting items listed below according to the procedures following the items and correcting any deficiencies found. Deficiencies not corrected should be reported promptly to the designated individual in authority.

(1) **ITEM 38, FUEL, OIL, AND WATER SUPPLY.** Make sure that there is adequate fuel, oil and coolant to operate vehicle to next scheduled stop; replenish as supply and tactical situation permits. In freezing weather, antifreeze of proper strength should be added if considerable coolant is needed.

(2) **ITEM 39, TEMPERATURES, HUBS, TRANSMISSION AND FINAL DRIVE.** Place hand cautiously on each track wheel and track support roller hub to see whether they are abnormally hot. If wheel hubs are too hot to touch with the hand, bearings may be inadequately lubricated, damaged or improperly adjusted. Check transmission and final drives for overheating or excessive oil leaks. On vehicles equipped with horizontal volute springs and shock absorbers, the shock absorbers should be warm after vehicle has been in operation.

(3) **ITEM 40, VENTS.** Examine vents of transmission and final drives to see that they are present, and not damaged or clogged.

(4) **ITEM 42, SPRINGS AND SUSPENSIONS.** Inspect all springs and bogie suspension units for looseness or damage. Remove stones and other foreign objects embedded in suspension system or between tracks. Inspect support roller bracket bolts, wedge nuts and bushing pin lock pins to see that they are present and secure.

(5) **ITEM 43, STEERING BRAKE LINKAGE.** Inspect linkage for looseness or damage and investigate any irregularities noted during operation.

(6) **ITEM 44, WHEEL AND FLANGE NUTS.** See that all sprocket, idler and bogie wheel and support roller assembly and mounting nuts are present and secure.

(7) **ITEM 45, TRACKS.** Examine tracks to see that they are present and not damaged. Make sure that track tension is satis-

TM 9-759

37-38

TANK, MEDIUM, M4A3

factory. Remove stones and trash from tracks and suspension systems.

(8) **ITEM 46, LEAKS—GENERAL.** Inspect vehicle generally for indications of fuel, oil and water leaks. Trace any leaks found to source and correct or report them.

(9) **ITEM 47, ACCESSORIES AND BELTS.** Examine accessible engine accessories, auxiliary and main generators and attachments to be sure they are secure, properly aligned and that drive belts are in good condition and properly adjusted. Belts should have $\frac{1}{2}$ to $\frac{3}{4}$ -inch finger-pressure deflection. If radio noise caused by operation of the main or auxiliary engine was observed, examine all wiring harness and coupling rings and nuts; engine, regulator and master switch bonding straps; regulator filters, auxiliary engine spark plug resistor-suppressor, and condensers across auxiliary generator brushes, for damage and loose connections and mountings.

(10) **ITEM 48, AIR CLEANERS AND BREATHER CAP.** When operating under extremely dusty or sandy conditions, inspect cleaners and breather cap at each halt to see that they are in condition to deliver clean air properly; service as required.

(11) **ITEM 49, FENDERS, SAND SHIELDS, AND GUARDS.** Inspect these items for good condition and secure mounting.

(12) **ITEM 50, TOWING CONNECTIONS.** See that connections are properly fastened and securely shackled. Examine for frayed or broken cable. Examine pintle hook for secure mounting and proper operation.

(13) **ITEM 61, HULL, TARPAULIN AND/OR CAMOUFLAGE NET.** Inspect for damage to hull or attachments. See that entrance and escape hatches operate freely and that camouflage net is in good condition and secure. **CAUTION:** *Do not fully open bottom escape hatch latch during inspection.* See that camouflage net is properly stowed.

(14) **ITEM 52, GLASS.** Clean all vision devices and light lenses; inspect these items for damage and security.

38. AFTER-OPERATION AND WEEKLY SERVICE.

a. After-operation servicing is particularly important because at this time the driver inspects his vehicle to detect any deficiencies that may have developed, and corrects those he is permitted to handle. He should report promptly to the designated individual in authority the results of his inspection. If this schedule is performed thoroughly, the vehicle should be ready to roll again on a moment's notice. The Before-operation Service, with a few exceptions, is then necessary only to ascertain whether the vehicle

FIRST ECHELON PREVENTIVE MAINTENANCE SERVICE

the same condition in which it was left upon completion of the After-operation Service. The After-operation Service should never be entirely omitted, even in extreme tactical situations, but may be reduced to the bare fundamental services outlined for the At-halt Service, if necessary.

b. Procedures. When performing the After-operation Service, the driver must remember and consider any irregularities noticed during the day in the Before-operation, During-operation and At-halt Services. The After-operation Service consists of inspecting and servicing the following items. Those items of the After-operation that are marked by an asterisk (*) require additional weekly services, the procedures for which are indicated in step (b) of each applicable item.

(1) **ITEM 56, INSTRUMENTS.** Check all pertinent instruments to be sure they are operating properly, and continue to register or indicate correct performance of units to which they apply. Inspect them for looseness and damage. See that all condensers and bonding straps are securely connected and mounted.

(2) **ITEM 55, ENGINE OPERATION.** Before stopping engine, accelerate and decelerate, noting any unusual noise or irregular performance; investigate any deficiencies noted during operation.

CAUTION: Allow engine to run at idle speed 2 to 3 minutes before stopping the engine. Open master battery switch and close fuel valves.

(3) **ITEM 54, FUEL, OIL, AND WATER.** Fill fuel tanks. Check coolant level and replenish as necessary. If appreciable amount of coolant is required, have value of antifreeze checked and add anti-freeze solution as needed. Bring engine oil to proper level. Replenish spare fuel, oil and water supply.

(4) **ITEM 57, HORN AND WINDSHIELD WIPERS.** If tactical situation permits, test horn for proper operation and tone. If in use, see that windshield and wipers are in good condition, that wipers operate properly and inspect blades and arms for good condition and security.

(5) **ITEM 58, GLASS.** Clean all vision devices and inspect for damage.

(6) **ITEM 59, LIGHTS.** Clean all light lenses and examine for broken parts and security of mounting. Turn on switches to see that all lamps operate.

(7) **ITEM 60, FIRE EXTINGUISHER.** See if portable extinguisher is in good condition and securely mounted. Inspect fixed system, cylinders, valves, lines and nozzles for looseness or damage. Be sure nozzles are not clogged. If extinguishers have been used, or valves opened or damaged, report for exchange or refill.

TANK, MEDIUM, M4A3

(8) **ITEM 61, DECONTAMINATOR.** Inspect decontaminator for damage and security of mounting. If decontaminator has been used, report for exchange or refill.

(9) **ITEM 62, *BATTERIES AND VOLTMETER.**

(a) Inspect battery for leaks or damage and security of mounting and connections.

(b) *Weekly.* Clean batteries and carrier, and inspect for loose or corroded terminals. If terminals are corroded, remove, clean and apply a thin film of grease. Add clean water to bring level to $\frac{1}{2}$ inch above plates. **NOTE:** *In freezing temperatures, do not add water until just before vehicle is to be operated.* On vehicles so equipped, when master switch is on, voltmeter should indicate voltage of batteries (approximately 24 volts).

(10) **ITEM 63, *ACCESSORIES AND BELTS.**

(a) Examine generator and fan belts for condition and proper adjustment. Inspect accessible vehicle accessories, auxiliary Homelite generator and oil cooler for good condition and secure mounting. Belts should have $\frac{1}{2}$ to $\frac{3}{4}$ -inch deflection under finger pressure halfway between pulleys.

(b) *Weekly.* Clean all trash from in and around oil cooler air core passages. Inspect Homelite unit for good condition and test for proper operation.

(11) **ITEM 64, *ELECTRIC WIRING.**

(a) Examine conduits for looseness or damage, tighten all loose connections and clean all accessible wiring.

(b) *Weekly.* Be sure all radio noise suppression bond straps, filters, condensers and suppressors on main and auxiliary units are securely connected or mounted (par. 152). Tighten wiring conduit coupling rings and nuts.

(12) **ITEM 65, AIR CLEANERS AND BREATHER CAP.** Examine carburetor air cleaners and breather cap, including auxiliary generator, to see that they are in good condition and securely connected. See that oil is at correct level and not excessively dirty. If excessive dirt is present, clean and service as necessary, according to Lubrication Order, paragraph 29 d (1).

(13) **ITEM 66, *FUEL, AND OIL FILTER.**

(a) Inspect fuel filter on Homelite unit and service as required. Test operation of engine oil filter at manual turning nut. See paragraph 61 b.

(b) *Weekly.* Remove and clean engine oil filter and Homelite fuel filter element in dry-cleaning solvent.

(14) **ITEM 67, ENGINE CONTROLS.** Inspect accelerator, hand throttle and all controls for worn or disconnected linkage.

FIRST ECHELON PREVENTIVE MAINTENANCE SERVICE**(15) ITEM 68, *TRACKS.**

(a) While inspecting tracks for damage and loose connections, remove all stones and foreign objects from between blocks and tracks and wheels and rollers. Check track tension. On vehicles equipped with vertical volute springs, track sag should be not less than $\frac{1}{2}$ inch or more than $\frac{3}{4}$ inch halfway between center and rear support rollers at sand shield inspection opening. On vehicles equipped with horizontal volute springs, there should be no track sag between the drive sprockets and the forward suspension wheels, or between the idler wheels and the rear suspension wheels. **CAUTION:** *Do not adjust track too tight on vehicle equipped with horizontal volute springs.*

(b) *Weekly.* Tighten all wedge nuts and on vehicles equipped with horizontal volute springs, see that bushing pin lock pins are secure.

(16) ITEM 69, *SPRING AND SUSPENSIONS.

(a) Inspect volute springs, spring seats, spring seat pins, support rollers and suspension arms to see that they are in good condition, correctly assembled and securely mounted. Examine rubber tires for cuts, breaks, or separation from wheels. On vehicles equipped with horizontal spring suspension, be sure shock absorbers are secure not leaking.

(b) *Weekly.* Tighten support roller bracket bolts, suspension bracket bolts and all clamp bolts. Inspect guides, sprockets and skids for excessive wear or damage.

(17) **ITEM 70, STEERING BRAKE LINKAGE.** Inspect levers, linkage and cross shafts for good condition, security, adequate lubrication and free operation. Investigate any unsatisfactory performance noticed during operation.

(18) **ITEM 71, *PROPELLER SHAFT (WEEKLY ONLY).** Examine shaft and universal joints to see that they are in good condition, secure and that joints are not leaking.

(19) ITEM 72, *VENTS.

(a) Inspect transmission and final drive vents to see that they are in good condition, secure and not clogged.

(b) *Weekly.* Remove vents, clean thoroughly and install securely.

(20) **ITEM 73, LEAKS.** Inspect engine crankcase, gear case, radiator and fuel tank lines, connections and seals for leaks.

(21) **ITEM 74, GEAR OIL LEVELS.** Check oil level in transmission and differential and add as necessary. Cold oil level should not be lower than $\frac{1}{2}$ inch below filler hole. **NOTE:** *Allow transmission to cool for 20 minutes after operation before checking level.*

TANK, MEDIUM, M4A3

(22) **ITEM 76, FENDERS AND SAND SHIELDS.** Inspect fenders, lamp guards and sand shields to be sure they are securely mounted and not damaged.

(23) **ITEM 77, TOWING CONNECTIONS.** Be sure towing cable is in good condition and securely attached or properly stowed. Examine pintle hook for good condition and proper operation of latch and locking mechanism.

(24) **ITEM 78, HULL, TARPAULIN AND/OR CAMOUFLAGE NET.** Examine entire hull for damage from shell fire or collision. Be sure top and floor escape hatches are alined and that they open and lock securely. *CAUTION: Do not fully open bottom escape hatch latch during inspection.* See that all hull drain plugs and inspection plates are in place and secure. Examine tarpaulin or camouflage net for damage and stow it properly.

(25) **ITEM 79, ARMOR.** Inspect bottom, sides, front, rear and turret armor for broken welds, loose hinges and latches. Check all hatches and pistol ports for good condition and proper operation.

(26) **ITEM 80, VISION DEVICES.** Inspect the periscope prisms and windows to see that they are in good condition, clean, secure in holders and see that holders are securely mounted. Examine periscope traversing, elevating and depressing mechanism. See that lever locking devices operate freely and are not excessively worn. Check the spare prisms and windows and their stowage boxes to see that they are in good condition, clean and secure. *CAUTION: Prisms should be cleaned only with a soft cloth or brush.*

(27) **ITEM 81, TURRET AND GUNS: MOUNTING, ELEVATING, TRAVERSING AND FIRING CONTROLS.** Be sure all mounted guns are secure in their mounts, clean, lightly oiled and in condition for immediate use. Test manual gun-elevating mechanism and all firing controls for proper operation. Be sure that manual and hydraulic traversing mechanism is in good condition and operates satisfactorily. Be sure radio noise suppression bonding strap and bonding cable at turret slip ring is in good condition, securely connected and supported. Correct or report to designated authority, any deficiencies noticed during operation.

(28) **ITEM 82, *TIGHTEN.**

(a) Tighten any unit mountings and assembly nuts or screws where inspection has indicated the necessity.

(b) *Weekly.* Tighten sprocket and idler flange nuts, track connector wedge nuts, universal joint flange, gun mounts, tool and equipment mountings, ammunition racks and clips or any other item where inspection or experience indicates the necessity on a weekly or mileage basis.

SECOND ECHELON PREVENTIVE MAINTENANCE**(29) ITEM 83, *LUBRICATION.**

(a) Lubricate all points of vehicle where inspection indicates the necessity or as indicated on the Lubrication Order as needing daily lubrication.

(b) *Weekly.* Lubricate all points of the vehicle indicated on the Lubrication Order as necessary on a weekly or mileage basis.

(30) ITEM 84, *CLEAN ENGINE AND VEHICLE.

(a) Remove all empty shell casings and refuse from interior of vehicle. Wipe up oil or fuel drippings from driving compartment, turret, and engine compartment. Remove excess dirt, stones and grease from tracks and suspension. See that engine compartment grilles are clear of obstructions.

(b) *Weekly.* Wash exterior of vehicle and remove all dirt and mud. If washing is impractical, wipe as clean as possible and watch for bright spots that would cause glare. If compressed air is available, blow all dirt out of engine compartment and transmission oil cooler fins in fighting compartment.

(31) ITEM 85, *TOOLS AND EQUIPMENT.

(a) Check vehicle tools and equipment stowage lists, paragraphs 6 through 11, to be sure all items are present, in serviceable condition, and properly stowed or mounted.

(b) *Weekly.* Clean tools and equipment. See that tools with cutting edges are sharp and properly protected. Be sure tools and equipment are mounted or stowed securely in proper location on, or in, vehicle.

Section XII**SECOND ECHELON PREVENTIVE MAINTENANCE****39. SECOND ECHELON PREVENTIVE MAINTENANCE SERVICES.**

a. Regular scheduled maintenance inspections and services are a preventive maintenance function of the using arm, and are the responsibility of commanders of operating organizations.

(1) **FREQUENCY.** The frequency of the preventive maintenance services outlined herein is considered a minimum requirement for normal operation of vehicles. Under unusual operating conditions, such as extreme temperatures and dusty or sandy terrain, it may be necessary to perform certain maintenance services more frequently.

(2) **FIRST ECHELON PARTICIPATION.** The drivers should accompany their vehicles and assist the mechanics while periodic second echelon preventive maintenance services are performed. Ordinarily the driver should present the vehicle for a scheduled preventive main-

TANK, MEDIUM, M4A3

tenance service in a reasonably clean condition; that is, it should be dry and not caked with mud or grease to such an extent that inspection and servicing will be seriously hampered. However, the vehicle should not be washed or wiped thoroughly clean, since certain types of defects, such as cracks, leaks and loose or shifted parts or assemblies, are more evident if the surfaces are slightly soiled or dusty.

(3) If instructions other than those contained in the general procedures in step (4) or the specific procedures in step (5) which follow, are required for the correct performance of a preventive maintenance service, or for correction of a deficiency, other sections of this manual pertaining to the item involved, or a designated individual in authority, should be consulted.

(4) **GENERAL PROCEDURES.** These general procedures are basic instructions which are to be followed when performing the services on the items listed in specific procedures. **NOTE:** *The second echelon personnel must be thoroughly trained in these procedures, so that they will apply them automatically.*

(a) When new or overhauled subassemblies are installed to correct deficiencies, care should be taken to see that they are clean, correctly installed and properly lubricated and adjusted.

(b) When installing new lubricant retainer seals, a coating of the lubricant should be wiped over the surface of the lip of the seal. When the new seal is a leather seal, it should be soaked in SAE No. 10 engine oil (warm, if practicable) for at least 30 minutes. Then, the leather lip should be worked carefully by hand, before installing the seal. The lip must not be scratched or marred.

(c) The general inspection of each item applies also to any supporting member or connection, and usually includes a check to see whether the item is in good condition, correctly assembled, secure or excessively worn. The mechanics must be thoroughly trained in the following explanation of these terms:

1. The inspection for "good condition" is usually an external visual inspection to determine whether the unit is damaged beyond safe or serviceable limits. The term "good condition" is explained further by the following terms: Not bent or twisted, not chafed or burned, not broken or cracked, not bare or frayed, not dented or collapsed, not torn or cut.

2. The inspection of a unit to see that it is correctly assembled is usually an external visual inspection to see whether it is in its normal assembled position in the vehicle.

3. The inspection of a unit to determine if it is secure is usually an external visual examination, a hand-feel, wrench or a pry-bar check for looseness. Such an inspection should include any brackets, lock washers, lock nuts, locking wire, or cotter pins used in assembly.

SECOND ECHELON PREVENTIVE MAINTENANCE

"Excessively worn" will be understood to mean worn close to, beyond, serviceable limits, and likely to result in a failure, if not replaced before the next scheduled inspection.

(d) *Special Services.* These services are indicated by repeating the item numbers in the columns that show the interval at which the services are to be performed and show that the parts or assemblies are to receive certain mandatory services. For example, an item number in one or both columns opposite a **TIGHTEN** procedure, means that the actual tightening of the object must be performed. The special services include:

1. *Adjust.* Make all necessary adjustments in accordance with the pertinent section of this manual, special bulletins, or other current directives.

2. *Clean.* Clean units of the vehicle with dry-cleaning solvent to remove excess lubricant, dirt and other foreign material. After the parts are cleaned, rinse them in clean fluid and dry them thoroughly. Take care to keep the parts clean until reassembled, and be certain to keep cleaning fluid away from rubber or other material which it will damage. Clean the protective grease coating from new parts, since this material is not a good lubricant.

3. *Special lubrication.* This applies either to lubrication operations that do not appear on the vehicle Lubrication Order or to items that do appear on such Orders, but which should be performed in connection with the maintenance operations, if parts have to be disassembled for inspection or service.

4. *Serve.* This usually consists of performing special operations, such as replenishing battery water, draining and refilling units with oil, and cleaning or changing the oil filter cartridge, or air cleaners.

5. *Tighten.* All tightening operations should be performed with sufficient wrench torque (force on the wrench handle) to tighten the unit according to good mechanical practice. Use torque-indicating wrench where specified. Do not overtighten, as this may strip threads or cause distortion. Tightening will always be understood to include the correct installation of lock washers, lock nuts and cotter pins provided to secure the tightening.

(e) When conditions make it difficult to perform the complete preventive maintenance procedures at one time, they can sometimes be handled in sections, planning to complete all operations within the week, if possible. All available time at halts and in bivouac areas must be utilized, if necessary, to assure that maintenance operations are completed. When limited by the tactical situation, items with Special Services in the columns, should be given first consideration.

(f) The numbers of the preventive maintenance procedures that now are identical with those outlined on W.D., A.G.O. Form

TANK, MEDIUM, M4A3

No. 462, which is the "Preventive Maintenance Service Work Sheet for Full Track and Tank-like Wheeled Vehicles." Certain items on the work sheet that do not apply to this vehicle are not included in the procedures in the manual. In general, the numerical sequence of items on the work sheet is followed in the manual procedures, but in some instances there is deviation for conservation of the mechanic's time and effort.

(5) **SPECIFIC PROCEDURES.** The procedures for performing each item in the 50-hour (500 miles) and 100-hour (1,000 miles) maintenance procedures, whichever shall occur first, are described in the following chart. **NOTE:** *Those procedures preceded by an asterisk (*) require additional services at each third 100-hours.* Each page of the chart has two columns at its left edge corresponding to the 100-hour and the 50-hour maintenance respectively. Very often it will be found that a particular procedure does not apply to both scheduled maintenances. In order to determine which procedure to follow, look down the column corresponding to the maintenance due, and whenever an item number appears, perform the operations indicated opposite the number.

MAINTENANCE	
100-Hour	50-Hour
1	1
2	2

ROAD TEST

NOTE: *When the tactical situation does not permit a full road test, perform those items which require little or no movement of the vehicle, namely items 2, 3, 5, 6, 9, 12, 13, 14, and 15. When a road test is possible, it should be for three miles, but not over five miles.*

1 Before-operation Service. Perform the Before-operation Service as outlined in paragraph 35.

2 Instruments and Gages. Check these items as follows:

OIL PRESSURE GAGE. Engine oil pressure must be indicated when engine is idling and 60 to 110 pounds at 2600 revolutions per minute. Stop engine immediately when "low oil" red indicator light comes on.

ENGINE TEMPERATURE GAGE. Reading should be approximately 90°F above atmospheric temperature. "Water Temp" light comes on at maximum operating temperature, 235°F. **CAUTION:** *Vehicle should not be moved until temperature is above 100°F.*

AMMETER. With a fully charged battery, ammeter reading may show charge for only a short time after starting engine, then zero or slightly above with all lights and electrical accessories turned off. If battery charge is low, ammeter will indicate higher charge for a longer period of time.

SECOND ECHELON PREVENTIVE MAINTENANCE

MAINTENANCE	
100-Hour	50-Hour
3	3
5	5
6	6

TACHOMETER. Inspect tachometer for proper reading, without excessive hand fluctuation or unusual noise. See that revolution counter registers accumulating revolutions.

FUEL GAGE. Operate selector switch to both R and L positions and observe whether fuel gage indicates approximate amount of fuel in each tank.

SPEEDOMETER AND ODOMETER. Speedometer should indicate vehicle speed and odometer register accumulating mileage without excessive noise or fluctuation.

TRANSMISSION OIL TEMPERATURE GAGE. On vehicles so equipped, gage should indicate the temperature of the transmission oil; under normal operation, temperature of transmission oil should not exceed 200° F.

OIL LEVEL GAGE. On vehicles so equipped, when engine is idling, pointer should indicate the amount of oil in the engine oil sump.

CLOCK. On vehicles so equipped, clock should be wound and set correctly.

VOLTMETER. On vehicles so equipped, voltmeter should indicate the battery voltage when master switch is on (approximately 24 volts).

Windshield, Windshield Wiper and Siren. If windshield is in use, see that wiper blades move through their full stroke and contact surface evenly. If tactical situation permits, test siren for operation and tone.

Brakes, (Steering and Parking, Levers, Braking Effect and Steering Action). Observe released position when steering levers. Levers are in correct position when horizontal distance from face of brake drum housing cover to front edge of lever is 7 to 7½ inches. Pull back on both steering brake levers and observe whether they stop the vehicle effectively and meet resistance slightly before the vertical position. With the vehicle on an incline, apply the parking brakes and observe whether they hold the vehicle securely and the levers remain in the applied position. Apply the steering brakes independently and notice whether they steer the vehicle properly.

Clutch (Free Travel, Drag, Noise, Grab, Chatter and Slip). Test pedal for correct free travel. Free pedal

TANK, MEDIUM, M4A3

MAINTENANCE	
100-Hour	50-Hour
7	7
9	9
14	14
10	10

travel must be maintained at $2\frac{7}{8}$ inches on vehicles equipped with clutch boosters, and at approximately 3 inches on vehicles not equipped with clutch boosters (par. 110 d). Clutch should not drag, and should engage without unusual noise or grabbing. Test clutch for slipping under load when engaged. Inspect clutch booster linkage, spring and connections to see that they are in good condition, correctly assembled and operate properly.

Transmission (Lever Action, Vibration and Noise). Shift through each speed range of transmission. Observe whether control lever operates properly and whether there are any unusual vibrations or noise in any speed range that might indicate damage, excessive wear, loose mountings, or improper lubrication.

Engine (Idle, Acceleration, Power, Noise, Smoke and Oil Consumption).

IDLE. With vehicle stopped, observe if engine runs smoothly at normal idling speed of 500 revolutions per minute. Throughout road test, observe whether there is any tendency of engine to stall when accelerator is released and hand throttle is closed.

ACCELERATION, POWER, VIBRATION AND NOISE. Test engine for normal acceleration and pulling power in each speed range. While testing in high range, accelerate engine from low speed with wide open throttle to top speed and listen for unusual engine noise, ping, or vibration that might indicate loose, damaged, excessively worn, or inadequately lubricated engine parts or accessories. Governed engine cruising speed should be approximately 2600 revolutions per minute. During road test, look for excessive smoke from exhaust or engine compartment.

OIL CONSUMPTION. At completion of road test, a check should be made to see if engine has been consuming an excessive amount of oil.

Noise and Vibration (Engine Mountings and Accessories). While accelerating and decelerating engine, listen for unusual noise in engine or accessories. Notice whether there is excessive vibration that may indicate loose engine mountings, or noise that may indicate loose or inadequately lubricated clutch parts or release bearings.

Unusual Noise (Propeller Shaft and U-Joints, Differential and Final Drives, Sprockets, Idlers, Bogie

SECOND ECHELON PREVENTIVE MAINTENANCE

MAINTENANCE		
100-Hour	50-Hour	
		Wheels, Support Rollers and Tracks). During road test, listen for any unusual noise from any of the above items that might indicate damaged, defective or loose parts, or inadequate lubrication.
11	11	Temperature (Transmission, Differential and Final Drives, Hubs, Sprockets, Bogie Wheels and Support Rollers). After operating, hand-feel for any abnormal temperature in above units. On vehicles equipped with horizontal volute springs, shock absorbers should feel warm while vehicle is being operated. NOTE: <i>If proper location is selected for this check, time will be saved in performing item 12.</i>
12	12	Gun Elevating and Traversing Mechanism. Place vehicle in a position where it is tilted (sidewise) about 10 degrees. Traverse turret through its full 360-degree range by both hand and power controls; check for binding, excessive lash or erratic action. With gun pointing forward, elevate it through its entire range with hand controls to check for indication of binding, excessive lash or erratic action.
13	13	Leaks (Engine Oil, Fuel and Water). After stopping vehicle, look in engine compartment, under vehicle, in fighting and driving compartments for fuel, oil or coolant leaks. Examine all fuel and oil lines and radiator hose and connections for leaks.
15	15	Track Tension (Final Road Test). Inspect for satisfactory track adjustment. On vehicles equipped with vertical volute springs, there should not be more than 3/4-inch nor less than 1/2-inch sag at inspection window in sand shield. On vehicles equipped with horizontal volute springs, there should be no sag between drive sprockets and forward suspension wheels and between idler wheels and rear suspension wheels. CAUTION: <i>On vehicles equipped with horizontal volute springs, do not adjust track tension too tight. To determine proper tension, place a wood block 3/4 inch thick and 2 inches wide between the track and each dual support roller. Tighten the track until the track just clears the single support rollers.</i>
16	16	Fuel Pump, Vacuum and Pressure Test. VACUUM TEST. Disconnect the fuel line which leads from the fuel pump to the fuel filter and attach a vacuum gage to the inlet of the fuel pump. Start the

TANK, MEDIUM, M4A3

MAINTENANCE	
00-Hour	50-Hour
17	17
18	18
19	19
20	20
20	
21	21

engine and run at a speed of approximately 700 revolutions per minute. The pump will build up a vacuum which should advance until it reads at least 10 inches. Stop the engine and observe the vacuum gage (the hand should fall back slowly). A fast rate of fall indicates a poor fuel pump outlet valve connection, loose cover screws, leaky diaphragm or loose connection.

PRESSURE TEST. Disconnect the fuel line which leads to the front carburetor and attach a pressure gage to the outlet of the fuel pump. Start the engine and run at a speed of approximately 700 revolutions per minute. Observe the reading of the pressure gage, which should be between 4½ and 6 pounds.

Crankcase (Leaks. Level). Examine the crankcase for indications of oil leaks and see if the oil is up to the correct level.

Side Armor (Fenders, Guards, Paint and Markings, Tow Shackles, Pintle and Horn). Examine vehicle for damage to side armor, fenders, sand shields, and guards from shell fire or collision; check for broken welds. Look for rust or bright spots in paint that might cause reflections. See that all vehicle markings are legible. Examine towing shackles and pintle for good condition and secure mountings. Test horn for operation and tone.

Bottom (Armor, Escape Hatches, Inspection Plates and Drain Plugs). Inspect hull bottom for damage. See that bottom escape hatch latch operates properly and is adequately lubricated, and see that all drain plugs are tight. Apply a few drops of oil to escape hatch latches. **CAUTION:** *Do not fully open bottom escape hatch latches during inspection.*

Final Drive. Inspect housings for good condition and leakage; check lubricant level. See that all assembly and mounting bolts are secure. **NOTE:** *If change of lubricant is due, drain and refill with specified oil at this time (pars. 28-30).*

TIGHTEN. Tighten all external assembly and mounting bolts securely.

***Track (Blocks, Connectors and Wedges).** Inspect tracks to see that these items are in good condition, correctly assembled and secure. Pay particular attention to loose connectors, bottomed wedges and dead blocks. On vehicles equipped with vertical volute springs,

SECOND ECHELON PREVENTIVE MAINTENANCE

MAINTENANCE	
100-Hour	50-Hour
21	
22	22
22	
23	23

tighten wedge nuts; on vehicles equipped with horizontal volute springs, see that bushing pin lock pins are present and secure.

**NOTE: Whenever the tracks are disconnected and removed from the sprockets, support rollers, and idlers, or at each third 100-hour maintenance service, the related items 22 and 25, marked by an asterisk (*) on the Preventive Maintenance Service Work Sheet W.D., A.G.O. Form No. 462, should be inspected as described below in the asterisk-marked (*) procedures. On the regular 50- to 100-hour maintenance services, the track should not be removed unless repairs are needed. CAUTION: Whenever tracks are removed for repair or replacement, do not reinstall tracks until the services followed by the (*) in items 22 and 25 have been completed.*

22 22 Idler (Wheels, Arms, Eccentrics, Serration Plates, Adjustment, Nuts and Springs). Inspect these items to see that they are in good condition, correctly assembled, secure, and that grease is not leaking excessively from wheel bearing seals. Be sure adjusting nuts and adjusting pin nut are secure. Tighten all assembly and mounting bolts and nuts securely.

**NOTE: In addition to the above, at each third 100-hour maintenance service or wherever the tracks are removed from the idlers, check the idler hub bearings for looseness or end play. Spin the idler wheels and listen for any unusual noise that might indicate a damaged, excessively worn or inadequately lubricated bearing.*

23 23 Bogie (Levers, Arms, Links, Gudgeons, Collars and Guides, Volute Springs and Seats, Frames and Wearing Plates). Inspect to see that these items are in good condition, correctly assembled and secure, and that gudgeons, collars and guides, and wearing plates are not excessively worn. Note whether volute springs have taken a permanent set. On vehicles equipped with vertical volute spring suspension (two or more coils resting on seat) and on vehicles equipped with horizontal volute springs, the measurement between spring seats must not be less than approximately 9½ inches. This condition or measurement will be considered a standard for replacement.

TANK, MEDIUM, M4A3

MAINTENANCE	
100-Hour	50-Hour
23	
24	24
24	
25	25
25	
26	26

TIGHTEN. Tighten all assembly and mounting nuts or screws securely.

Wheels (Tires, Rollers and Skids). Inspect these items for good condition, correct assembly and secure mounting. Pay particular attention to see that tire rubber has not separated from wheel and roller rims, and that tires are not cut, torn or excessively worn. Inspect for excessive lubricant leaks from bearings.

TIGHTEN. Jack up bogie wheels (par. 136 b) and examine bearings for looseness and end play. Spin wheels and listen for any unusual noise. Tighten assembly and mounting bolts securely.

Sprockets (Hubs, Teeth and Nuts). Inspect sprockets to see that they are in good condition, correctly assembled and mounting bolts are secure. Inspect sprocket teeth for excessive wear and shaft flange gaskets or oil seals for excessive leaks. If sprocket teeth are excessively worn, sprockets should be replaced or reversed. Tighten assembly and mounting bolts securely. **NOTE:** *Whenever the tracks are removed, the above operation should be performed before the tracks are reinstalled.*

***NOTE:** *In addition to the above, at each third 100-hour operation, or whenever the track is disconnected and removed from the sprocket, check the sprocket hub bearings for looseness and end play. Check the sprocket teeth for excessive wear and see that sprockets are secured to hubs and that hub to final drive bolts are secure. After performing the above, reinstall the tracks and connect them securely.*

Track Tension. On vehicles equipped with vertical volute spring suspension, there should not be more than 3/4-inch nor less than 1/2-inch sag at inspection window in sand shield or halfway between the two rear support rollers. On vehicles equipped with horizontal volute spring suspension, there should be no sag between the drive sprockets and the forward suspension wheels and between the idler wheels and the rear suspension wheels. Adjust track tension to these standards and lock securely. **CAUTION:** *On vehicles equipped with horizontal volute spring suspension, do not adjust tracks too tight. To determine proper tension, place a wood block*

SECOND ECHELON PREVENTIVE MAINTENANCE

MAINTENANCE	
100-Hour	50-Hour
27	27
28	28
30	30
30	
32	
33	
34	34

$\frac{3}{4}$ inch thick and 2 inches wide between the track and each dual support roller. Tighten the track until the track just clears the single support rollers.

Top Armor (Turret, Deck, Paint and Markings, Grilles, Hatches, Latches and Antenna Mast). Inspect these items to see that they are in good condition and secure. See that turret hatch traverses properly, that hatches, grille, hatch hinges and latches operate freely. Note whether they are excessively worn, adequately lubricated, and that grilles are not obstructed. Examine paint for rust spots or polished surfaces that may cause reflections and see that vehicle markings are legible.

Caps and Gaskets (Fuel Tanks and Radiator). Observe whether they are in good condition, whether the caps lock securely on the filler necks and that their vents are open.

Engine Removal (When Required). Remove engine on 100-hour maintenance service, only if inspections made in items 6, 9, 13, and 14 and a check of oil consumption indicated definite need. **CAUTION:** *Be sure the magnetos are grounded when removing engine.*

CLEAN. Clean exterior of engine and dry thoroughly, taking care to keep dry-cleaning solvent away from electrical wiring, terminal boxes, and equipment.

SPARK PLUGS. Remove all spark plugs and examine them for cracks or broken insulators, excessive carbon deposits and burned electrodes. Unserviceable plugs and those having gaps in excess of 0.030 inch must be replaced. **NOTE:** *Perform item 33 before reinstalling plugs.*

COMPRESSION TEST. While spark plugs are removed, test compression of each cylinder and record reading on back of Form 462. Throttle must be opened during compression test. Normal compression at cranking speed is 155 to 180 pounds. The allowable amount of variation between cylinders is 15 pounds.

Generator and Cranking Motor. Inspect these items for good condition and security of mounting; make sure wiring connections are secure. Inspect generator drive belts to see that they are in good condition and adjusted to $\frac{1}{2}$ to $\frac{3}{4}$ -inch finger-pressure deflection. See that all

TANK, MEDIUM, M4A3

MAINTENANCE	
100-Hour	50-Hour
34	
37	37
37	
67	
38	38
42	42
42	42
43	43

radio noise suppression shielding, condensers and bonding straps are securely connected.

SERVE. Remove generator commutator inspection cover and examine commutator for good condition. See that brushes are free in brush holders, clean, and not excessively worn; that brush connections are secure and that wires are not broken or chafing. Clean commutator end of generator by blowing out with compressed air. Tighten cranking motor and generator mounting bolts securely.

Magnetos. Inspect magnetos for good condition and security of mounting and note whether there is evidence of oil leaks at mounting pad gaskets. Remove breaker point inspection covers to see that points are not pitted, are clean and well aligned with mating surfaces, and are engaging squarely.

ADJUST. Adjust magneto breaker point gaps to 0.016¹ inch (par. 66 c (3)).

Ignition Timing. Check and set ignition timing (par. 67).

Ignition Wiring and Conduits. Inspect these items for good condition, cleanliness, correct assembly, tight connections, security of mountings, and for chafing against other engine parts. See that all radio noise suppression shielding from magnetos to spark plugs and instrument panel is in good condition, clean, properly and securely mounted and supported. Clean all exposed ignition wiring with a dry cloth. **NOTE:** *Do not disturb connections unless they are actually loose.*

Breather Caps and Ventilators. See that they are in good condition, correctly assembled and secure and that ventilator tubes are open.

CLEAN AND SERVE. Remove the cleaner element from the breather cap and clean elements and body in dry-cleaning solvent; dry, dip the element in engine oil, drain off excess oil and reinstall them securely. See Lubrication Order, paragraph 28.

Air Cleaners (Carburetor). Inspect air cleaner parts to see if they are in good condition. Clean the reservoirs and elements in dry-cleaning solvent and drain. Fill reservoirs to correct level with used or new engine oil. See Lubrication Order, paragraph 28. Reassemble

SECOND ECHELON PREVENTIVE MAINTENANCE

MAINTENANCE	
100-Hour	50-Hour
44	44
45	45
45	
46	46
48	48
48	
49	49

cleaners, making certain all gaskets are in good condition and in place. Give special attention when mounting to see that cleaners are pressed firmly in place against air horn seals and cleaners are securely fastened.

Carburetor (Linkage, Governor and Primer). Inspect these units for good condition, correct assembly and security of mounting. See that carburetors do not leak, that governor linkage is not excessively worn and operates freely. Remove the fuel level checking plug on each carburetor to determine if the fuel in the carburetor float chamber is at the correct level (par. 72 d). Adjust the carburetor idle fuel mixture (par. 72 b). See that governor is properly sealed. Make sure that lines of priming system are in good condition, secure and not leaking.

Manifolds. Inspect to see that all manifolds, manifold gaskets and connections are securely fastened, correctly assembled and not leaking.

TIGHTEN. Tighten all loose assembly and flange nuts.

Cylinder (Heads and Gaskets). Inspect externally for compression or coolant leaks around gasket joints, studs and connections. **CAUTION:** *Cylinder head stud nuts should not be tightened unless there is a definite indication of looseness or leaks. If tightening is necessary, a torque-wrench must be used and nuts tightened in proper sequence (par. 58 c (3)).*

Clutch Assembly. Examine visible parts of clutch housing for loose mounting and cracks. Examine all linkage for presence of cotter pins and return spring. Pedal free travel must be approximately 2 $\frac{7}{8}$ inches on vehicles that are equipped with clutch boosters and approximately at 3 inches on vehicles not equipped with boosters. See paragraph 110 d.

On engines that are removed only, disassemble clutch, clean parts thoroughly and inspect for excessive wear or damage. If any part is unserviceable, report condition to higher echelon.

Water Pump (Fans and Shrouds). Observe whether these items are in good condition, correctly assembled and secure. See that water pump does not leak. Note particularly whether there is end play or bearing looseness in water pump or fans. Check to see that fan

TANK, MEDIUM, M4A3

MAINTENANCE	
100-Hour	50-Hour
50	50
50	
51	51
51	
53	53
53	
54	54
56	56
57	57
57	
58	58

blades and shrouds are properly alined and do not interfere.

Accessory Drives (Belts, Pulleys, Shafts and Couplings). See that these items are in good condition, correctly assembled and secure. Pay particular attention to see whether or not drive belts and pulleys are well alined and not excessively worn. Check to see that fan accessory drive universals are in good condition and operating properly.

ADJUST. Adjust fan and generator drive belts to have 1/2 to 3/4-inch deflection under finger pressure, halfway between pulleys. See that adjusting locks are securely fastened.

Engine Compartment (Bulkhead and Control Linkage). Check to see that engine compartment, including bulkhead, is in good condition and clean, and that control linkage in engine compartment is in good condition and securely connected and mounted.

CLEAN. Clean engine compartment thoroughly. Whenever engine is removed, clean out all fuel and oil drippings, dirt and refuse, wipe out the engine compartment with cloths soaked in dry-cleaning solvent, and dry thoroughly.

Fuel (Tanks, Lines and Pump). Inspect to see that these items (where visible) are in good condition, correctly assembled, securely mounted and not leaking.

TIGHTEN. Tighten accessible fuel line support clips securely.

Engine Oil Filter. Remove filter element from housing and clean out all solids collected in filter sump. If element is serviceable, reinstall and test operation of filter (par. 61 h).

Transmission Oil Cooler. Inspect core and lines of cooler to see that they are in good condition, secure and not leaking. Clean out insects and trash from in and around core air passage.

Exhaust Pipes. Inspect to see that these items are in good condition and securely assembled and mounted.

TIGHTEN. Tighten all mounting bolts and connections securely.

Engine Mounting. Observe all accessible mountings and radio bond straps to see that they are in good condition and secure.

SECOND ECHELON PREVENTIVE MAINTENANCE

MAINTENANCE		
100-Hour	50-Hour	
58		TIGHTEN. Tighten all mounting bolts and bond straps securely. When engine is removed, tighten all engine mounting and support assembly bolts securely.
60	60	Fire Extinguisher System (Tanks, Valves, Lines, Nozzles and Mountings). Inspect lines, connections and cylinders of both fixed and portable fire extinguishers for good condition, secure mounting and full charge. Full charge may be observed by presence of intact wire seals but can be positively determined by weighing. Examine control cables of fixed extinguishers to see that they are in good condition and free to operate at a moment's notice. See that all lines and nozzles are in good condition, securely mounted and connected, with nozzles properly aimed and not clogged.
60		TIGHTEN. Tighten all assembly and mounting bolts securely.
61	61	Engine Installation (Mountings, Lines and Fittings, Wiring, Control Linkage and Oil Supply). If engine was removed for repair or replacement, reinstall at this time (par. 64). Tighten mountings and bond straps securely and connect all fuel and oil lines and control linkage correctly. Be sure oil supply is adequate. See that all wiring is properly connected and coolant lines are not leaking.
62	62	Radiator (Core, Mountings, Hose and Antifreeze Record). Examine above items to see that they are in good condition, properly assembled and securely mounted. See that core air passages are free of all obstructions and not bent. Check all hose and pipe connections and filler cap for leaks. If antifreeze is used, check its value and record on Form No. 462; add as needed to prevent freezing. Clean out all trash from radiator core passages. If inspection indicates cleaning is necessary and always when antifreeze is installed or removed, proceed only according to paragraph 83 and current directives regarding proper procedures, cleaner, neutralizer and inhibitor. Refill radiator with proper coolant, allowing room for expansion. On radiators which are removed, perform this inspection partly while removed from the vehicle and partly after replacement, as necessary to make the complete inspection properly.

TANK, MEDIUM, M4A3

MAINTENANCE	
100-Hour	50-Hour
62	
63	63
63	
63	63
63	63
64	64
64	65
66	66

SERVE. Reinstall removed radiator. Tighten all mountings and hose or tubing connections securely. Fill the cooling system, adding antifreeze or inhibitor as required and recheck the cooling system for leaks.

Batteries (Cables, Hold-Downs, Carrier and Gravity). Inspect battery case for cracks and leaks. Clean top of batteries and inspect terminals, bolts, post straps and hold-downs to see that they are in good condition. Test specific gravity and record on space provided on back of Work Sheet W.D., A.G.O. Form No. 462. Gravity readings below 1,225 indicate batteries need recharging or replacement.

Perform high rate discharge test according to instructions for a condition test which accompanies test instrument. Cell variation should not be more than 30 percent. **NOTE:** *Specific gravity must be above 1.225 to make a test.*

Clean batteries and carrier, repaint carrier if corroded. Clean cables, terminals, bolts, posts and grease lightly. Inspect bolts and nuts to see that they are in good condition and grease lightly. Tighten terminals and hold-downs carefully to avoid damage to battery.

SERVE. Add clean water to bring electrolyte 1/2 inch above plates.

Accelerator (Linkage). Examine accelerator and connecting linkage to see that it is in good condition, opens both carburetor throttles properly, is securely connected and operates freely. **NOTE:** *Open fuel valves and close master battery switch at this time.*

ADJUST. Adjust throttle control linkage (par. 77).

Cranking Motor (Primer Instruments). Start engine and observe if primer operation and action of cranking motor is satisfactory. Note particularly whether cranking motor drive engages and operates properly without unusual noise, whether it has adequate cranking speed, and whether engine starts readily. As engine starts, see that all instruments operate properly and particularly, that oil pressure and ammeter indications are satisfactory.

Leaks (Engine Oil, Fuel and Water). While engine is running, inspect within the engine compartment for

SECOND ECHELON PREVENTIVE MAINTENANCE

MAINTENANCE		
100-Hour	50-Hour	
68	68	water leaks from the cooling system; for oil leaks from engine or lines and any leaks from the fuel system.
		Regulator Units (Connections, Bond Straps and Filters). Inspect generator regulators to see if they are in good condition, securely connected and mounted. See that radio suppression bond straps and capacitors are in good condition, securely connected and mounted.
69	69	Engine Idle. Adjust the idle of the engine as outlined in paragraph 72 c.
70	70	Throttle Synchronization. Inspect throttle linkage connections and adjustment on both carburetors to see that they are in good condition and properly adjusted (par. 77 b). See that the engine idles with throttle closed and responds properly when opened. Allow engine to idle 3 to 4 minutes to cool properly before stopping.
71	71	Fighting Compartment (Paint, Seats, Safety Straps, Crash Pads, Stowage, Ammunition Boxes, Clips and Racks). Inspect to see that these items are in good condition and securely assembled and mounted. See that fighting compartment is clean, that paint is in satisfactory condition, and that adjusting mechanism of seats operates properly and is adequately lubricated. Pay particular attention to see that all dividers and shell pads are present and properly installed in ammunition boxes and racks, and that clips have sufficient tension to hold shells securely.
71		On vehicles so equipped, see that solution in wet stowage ammunition containers is visible at filler plugs and that all plugs are present and secure. If additional solution is required, see paragraph 138 b (2) for correct mixture.
72	72	Turret and Locks. Inspect to see that these items are in good condition and securely assembled and mounted and that lock operates properly and turret traverses easily when lock is released.
73	73	Periscopes. Examine periscope prisms and windows to see that they are in good condition, clean and secure in holders. Make sure that holders are securely mounted. See that lever and locking devices operate freely and are not excessively worn and that their traversing and elevating devices are free and not excessively worn. Examine spare periscopes and their stowage boxes to see that they are in good condition, clean and secure.

TANK, MEDIUM, M4A3

MAINTENANCE	
100-Hour	50-Hour
74	74
75	75
75	
77	77
77	
80	80
81	81

CAUTION: *Prisms should be cleaned only with a soft cloth or brush.*

Clutch Pedal (Free Travel, Linkage and Return Spring). Inspect to see that these items are in good condition, securely assembled and mounted, well lubricated, and not excessively worn. Be sure return spring will bring pedal to full released position. Examine clutch booster linkage, spring and mountings, to see that they are in good condition, operate properly and are securely mounted. Clutch pedal free travel must be maintained at $2\frac{7}{8}$ inches on all vehicles equipped with a clutch booster and at approximately 3 inches if not equipped with a clutch booster. See paragraph 110 d.

Brakes (Steering, Parking Levers, Latches and Linkage). Check released position of steering levers. Levers are correctly positioned when horizontal distance from face of brake drum housing cover to front edge of lever is 7 to $7\frac{1}{2}$ inches. Pull back on both steering brake levers and observe whether they meet resistance slightly before the vertical position. Apply the brakes with parking brake latch on, and observe whether levers remain in the applied position. Examine linkage connections, ratchets and pawls for security and good condition.

TIGHTEN. Tighten all assembly and mounting nuts and screws securely.

Final Drive and Breather. Examine accessible part of the final drive case in driver's compartment to see that it is in good condition, that all mounting and assembly bolts or cap screws are secure, and that there are no leaks. Inspect breathers to see that they are in good condition, secure and not clogged.

CLEAN AND TIGHTEN. Remove breathers and clean thoroughly. Tighten all external assembly and mounting bolts and screws securely.

Transmission Control. Inspect to see that transmission control lever operates properly, is in good condition, correctly assembled, securely connected and not excessively worn

Propeller Shaft (U-Joints, Alinement and Flange) Inspect propeller shaft to see that it is in good condition, that it is correctly assembled and securely mounted, and that universal joints are properly alined and not excessively worn.

SECOND ECHELON PREVENTIVE MAINTENANCE

MAINTENANCE		
100-Hour	50-Hour	
81		TIGHTEN. Tighten universal joint assembly and companion flange bolts securely.
84	84	Compass and Lamp. Examine compass for good condition and secure mounting, and see that compass lamp is properly aimed. Test compass, and if adjustment is found to be necessary, report to designated individual in authority.
85	85	Lamps and Switches (Head, Tail, Blackout and Internal). Test to see that switches and lamps operate properly. Inspect all lights for good condition, security, for broken lenses or discolored reflectors.
85		ADJUST. Adjust headlamp beams.
86	86	Wiring (Junction and Terminal Blocks, Boxes, Circuit Breakers and Buttons). Inspect all of these units to see that they are in good condition, securely mounted and connected. Inspect all exposed wiring and conduits for looseness or damage and see that they are well supported and securely connected. Be sure radio noise suppression, capacitors, clips and bond straps are in good condition, clean and securely mounted or connected.
87		Collector Ring (Brushes, Heads, Cylinder and Cover). With master battery switch off, remove collector ring (slip ring) cover and examine to see that above listed items are in good condition and clean and whether brushes contact cylinder evenly under normal spring tension. See that leads are securely connected and not chafing. Be sure cover is reinstalled securely and that bonding strap is in good condition and securely connected.
88	88	Radio Bonding (Suppressors, Filters, Condensers and Shielding). See that all units not covered in the foregoing specific procedures are in good condition, securely mounted and connected. Be sure all additional noise suppression bond straps and internal-external toothed washers listed in paragraph 152 are inspected for looseness or damage, and see that contact surfaces are clean. NOTE: <i>If objectionable radio noise from the vehicle has been reported, make test in accordance with paragraph 54 c.</i> If cleaning and tightening of mountings and connections, and replacement of

TANK, MEDIUM, M4A3

MAINTENANCE	
100-Hour	50-Hour
89	89
90	90
91	91
91	
92	92
92	
93	93
94	94

defective radio suppression units does not eliminate the trouble, the radio operator will report the condition to the designated individual in authority.

Engine (Crankcase, Fan and Housing, Cylinder, Shroud, Mountings and Exhaust Pipe). Inspect to see that these items are in good condition and securely mounted. See that there are no leaks in exhaust line or around gaskets, and that shroud damper operates freely. See that radio noise suppression bond straps are in good condition, securely mounted and connected.

Spark Plug. Remove and inspect spark plug for broken insulator or burned electrodes; gap must be 0.025 inch. Replace unserviceable plug, using new gasket. See that spark plug radio noise suppressor is in good condition and securely connected.

Magneto (Points, Wiring and Shield). Inspect to see that these items are in good condition, correctly assembled, and securely mounted. Make sure the interior of magneto and rotor arm are in good condition and clean, and that breaker points are clean and not uneven or pitted. When so equipped, see that radio noise suppression capacitor is in good condition, securely mounted and connected.

ADJUST. Breaker points must be properly alined, not pitted and the gap adjusted to 0.020 inch with points fully opened.

Carburetor Air Cleaner. Inspect to see that air cleaner is in good condition, securely mounted and not leaking.

CLEAN. Remove air cleaner element, clean in cleaning solvent and dry thoroughly. Dip element in engine oil, drain and reassemble.

Fuel (Filter, Line, Tank, and Cap). Examine to see that these items are in good condition, secure, and not leaking. Close fuel tank shut-off valve and clean fuel filter sediment bowl and screen; reinstall, using new gasket, if necessary. Open fuel supply valve and check for leaks.

***Generator (Commutator, Brushes, Control Box, Wiring).** Remove brush head cover plate, and examine commutator to see that it is in good condition, clean and not excessively worn. See that brushes are clean, free in their holders, properly spring-loaded, and not excessively worn, and that radio noise suppression con-

SECOND ECHELON PREVENTIVE MAINTENANCE

MAINTENANCE		
100-Hour	50-Hour	
94		<p>densers on brush holding plate are in good condition and securely connected. Inspect control box and buttons, ammeter and wiring to see that they are in good condition, correctly assembled and connected and secure.</p> <p>CLEAN. At each third 100-hour service, clean commutator by placing a strip of flint paper 2/0 (not emery) over a block of wood of correct size; with engine running, press flint paper against commutator until it is clean. Blow out dust with compressed air.</p>
95	95	<p>Operation (Engine, Generator, Ammeter, and Leaks). Start engine, observing whether it starts easily and runs at normal speed. Listen for any unusual noise. See that generator output is 50 amperes. Examine fuel system for leaks. <i>NOTE: If vehicle is equipped with heater unit and duct, be sure that heater operates and the duct is in good condition, clean and secure. Check operation of heat damper.</i></p>
125	125	<p>Bow Gun (Mounts). See that mount is in good condition, clean, well-lubricated, and secure. Elevate and traverse gun through its entire range to see if mount operates without binding or looseness, and that firing control operates properly.</p>
125		<p>TIGHTEN. Tighten all assembly nuts and screws securely.</p>
126	126	<p>Gun: 75-mm, 76-mm and 105-mm Howitzer (Mount, Traversing and Elevating Mechanism and Firing Controls). Inspect to see that these items are in good condition, clean, well-lubricated, correctly and securely assembled, and not excessively worn. Check to see that manual and hydraulic traversing controls are in good condition and secure; paying particular attention to wiring, switches, and connections. Operate each firing control, both manual and electric, to see that they function properly. Operate hand elevating controls through entire range to see that they function properly. Traverse turret by hand to see that there is no binding and that turret can be turned through its entire 360-degree range. See whether the brake is effective when hand control brake latch is released. Inspect power traversing system, including motor pump, reservoir, wiring, and operating controls, to see that they operate properly, are in good condition, correctly assembled, secure, and are not excessively worn. See that radio noise suppression units</p>

TANK, MEDIUM, M4A3

MAINTENANCE	
100-Hour	50-Hour
126	
127	127
127	
128	128
128	
129	129
130	130
131	131

are in good condition and securely connected. Examine hydraulic system for leaks and oil reservoir for proper level of oil; add oil if required. Tighten all assembly and mounting bolts and screws securely.

TIGHTEN. Tighten gun mounts securely.

Stabilizer and Recoil Control. Inspect stabilizer control unit, gear box, connecting oil lines, cylinder and piston, wiring and control box to see that they are in good condition, secure, correctly assembled and connected and not leaking oil. Make an operating test of the stabilizer by pressing gun breach. If gun returns to aimed position without excessive vibration or hunting, system is satisfactory. If hunting occurs, adjust stiffness control knob; right to stiffen, left to loosen. Defects in system should be referred to ordnance personnel for attention. Check recoil cylinders to see that they are in good condition and not leaking. **NOTE:** *Recoil operating tests must be made under firing conditions in accordance with instructions in parts V, VI and VII (Armament).*

TIGHTEN. Tighten all mounting and assembly nuts and screws securely.

A.A. Gun and Bomb Thrower (Mounts, Traversing and Elevating Mechanism). Inspect to see that these items are in good condition, clean, secure, and adequately lubricated. Make sure that mechanism operates freely.

TIGHTEN. Tighten all assembly and mounting bolts securely.

Spare, Gun, Barrels and Parts. See that all items are present, in good condition, and properly stowed.

TOOLS AND EQUIPMENT

Tools (Vehicle and Pioneer). Check standard vehicle tools against stowage lists to see that they are pioneer tools and present, in good condition, and properly stowed or mounted. Any tools mounted on outside of vehicle, having bright or polished surfaces, should be painted or otherwise treated to prevent glare or reflections. Tools with cutting edges should be sharp, and edges should be protected.

Equipment. Check special equipment items against vehicle stowage lists (pars. 6 through 11) to see if they

SECOND ECHELON PREVENTIVE MAINTENANCE

MAINTENANCE	
100-Hour	50-Hour
132	132
133	133
134	134
135	135
136	136
137	137
138	138
139	139

are all present, in serviceable condition and properly stowed or mounted.

Spare Track Blocks. Inspect to see if these items are all present, in good condition, and properly stowed or mounted.

Spare Oil Supply (Recoil, Hydraulic and Engine). Check to see that supply of listed spare oil is present and properly stowed. This supply should be maintained at all times.

Decontaminator. Examine to see that decontaminator is in good condition, secure and fully charged. Make latter check by removing filler plug.

Fire Extinguishers (Portable). Inspect to see that extinguishers are fully charged, in good condition, and securely mounted and seal on valve head is intact. Replace with a fully charged extinguisher, if weight is not up to specifications (par. 7 b).

Publications and Form No. 26. Check to see whether vehicle manuals, Lubrication Order, Accident-Report Form No. 26, and MWO Major Unit Assembly Replacement Record W.D., A.G.O. Form No. 478 are present, legible, and properly stowed.

Vehicle Lubrication. If due, lubricate in accordance with Lubrication Order, Section IX, and current lubrication directives, using only clean lubricant and omitting items that have had special lubrication during this service. Replace damaged or missing fittings, vents, flexible lines or plugs.

Modification (Work Orders Completed). Inspect vehicle to determine that all Modification Work Orders have been completed, and entered on W.D., A.G.O. Form No. 478. Enter any replacement of major unit assembly made at time of this service.

Final Road Test. Make a final road test, rechecking items 2 to 15 inclusive. Recheck transmission and differential to see that lubricant is at correct level, and that there are no leaks. Confine this road test to minimum distance necessary to make satisfactory observations. While testing vehicle, operate it in a normal manner. *NOTE: Correct any deficiencies found during final road test.*

TM 9-759

40-41

TANK, MEDIUM, M4A3

Section XIII

TROUBLE SHOOTING

40. INTRODUCTION.

a. **General.** This section contains trouble shooting information and tests for the entire vehicle which can help determine the causes of some of the troubles that may develop in the vehicle. Under each unit or system are listed symptoms of the troubles which are most prevalent. Where a symptom may be caused by more than one condition, simple tests are described that will locate the trouble in a particular unit or system, or eliminate a particular unit or system from further consideration.

b. **Electrical Wiring.** The wires in the electrical circuits used in the wet stowage and the 105-mm howitzer vehicles are of the same color (natural color). The wires can be identified by number attached to each wire. The wires in the electrical circuit used in the 75-mm dry stowage vehicle are of different colors. The wires can be identified by the color of wire. A further description of the wiring is covered in paragraph 101.

41. ENGINE.

a. **Engine Will Not Crank.** Check the starting system (par. 44). Remove the spark plugs and crank the engine with the cranking motor to check for accumulation of water in the cylinders (hydrostatic lock). If the engine can be cranked with the spark plugs removed, and cannot be cranked with the spark plugs in place, this will indicate a water leak into the cylinders. If the engine cannot be cranked with the spark plugs removed, it will indicate that a reciprocating part in the engine has seized. In either case notify higher authority.

b. Engine Cranks But Will Not Start.

(1) **PRELIMINARY INSTRUCTIONS.** If the engine is hot, hold the foot throttle open and crank the engine; this will clear away any vapor lock which may be present. If the engine is extremely cold, see paragraph 25.

(2) **CHECK FUEL SYSTEM.** Check to see that the fuel shut-off valves are open (figs. 9 and 10). Remove the outlet fuel line from the fuel pump, and, with the ignition switch in the "OFF" position, crank the engine with the cranking motor. If a free flow of fuel is not evident, fuel is not reaching the carburetor. See paragraph 45 a.

TROUBLE SHOOTING

(3) **CHECK IGNITION SYSTEM.** Turn the ignition switch on. Remove a wire from a spark plug, and hold the wire terminal approximately one-quarter inch from the cylinder head. Crank the engine. If a spark does not jump the one-quarter inch gap, the ignition system is at fault. See paragraph 42.

c. **Engine Backfires But Will Not Start.** Check to see that the spark plug wires are attached to the magneto distributor plates in their proper firing order (fig. 33). Check ignition timing (par. 67).

d. **Engine Will Not Develop Full Power.** If the engine does not develop full power, follow Preventive Maintenance procedure (par. 39).

e. **Engine Misfires.** If the engine misfires, follow Preventive Maintenance procedure (par. 39).

f. **Engine Runs Unevenly, and Black Smoke Is Emitted From Exhaust.** Check fuel system (par. 45 b).

g. **Engine Runs Unevenly and Backfires Through the Carburetor After It Is Warmed Up.** Check to see that the spark plug wires are attached to the magneto distributor plate on the magnets in their proper firing order (fig. 33). Check ignition timing (par. 67). If the ignition is found to be satisfactory, it can be assumed that the fuel mixture is too lean. Refer to paragraph 72 b.

h. **Engine Overheats.** If the engine compartment doors are equipped with shutters, make sure they are open. Check for low water in the cooling system, and refill with coolant if required. Adjust the fan belts if loose (par. 86 b). If the air flow through the radiator is restricted, clean the radiator fins and air passages. Check the ignition timing, and retime if required (par. 67). If the engine continues to overheat, replace the thermostat (par. 88).

i. **Excessive Oil Consumption.** Examine the oil in the engine, and if the viscosity of the oil is found to be low, refill with specified grade. Inspect the engine for external oil leaks. Tighten any oil line connections found leaking. Tighten or replace gaskets as required, or notify higher authority. If the engine continues to use oil after making the above inspection or replacements, it may be assumed the pistons or piston rings, or the intake valve guides are worn or damaged, in which case notify higher authority.

j. **Low or No Oil Pressure.** Check the oil supply in the engine and replenish it with specified grade if required (see Lubrication, par. 29 d (8)). If the oil in the engine has become overdiluted, it must be replaced with the grade specified.

TANK, MEDIUM, M4A3

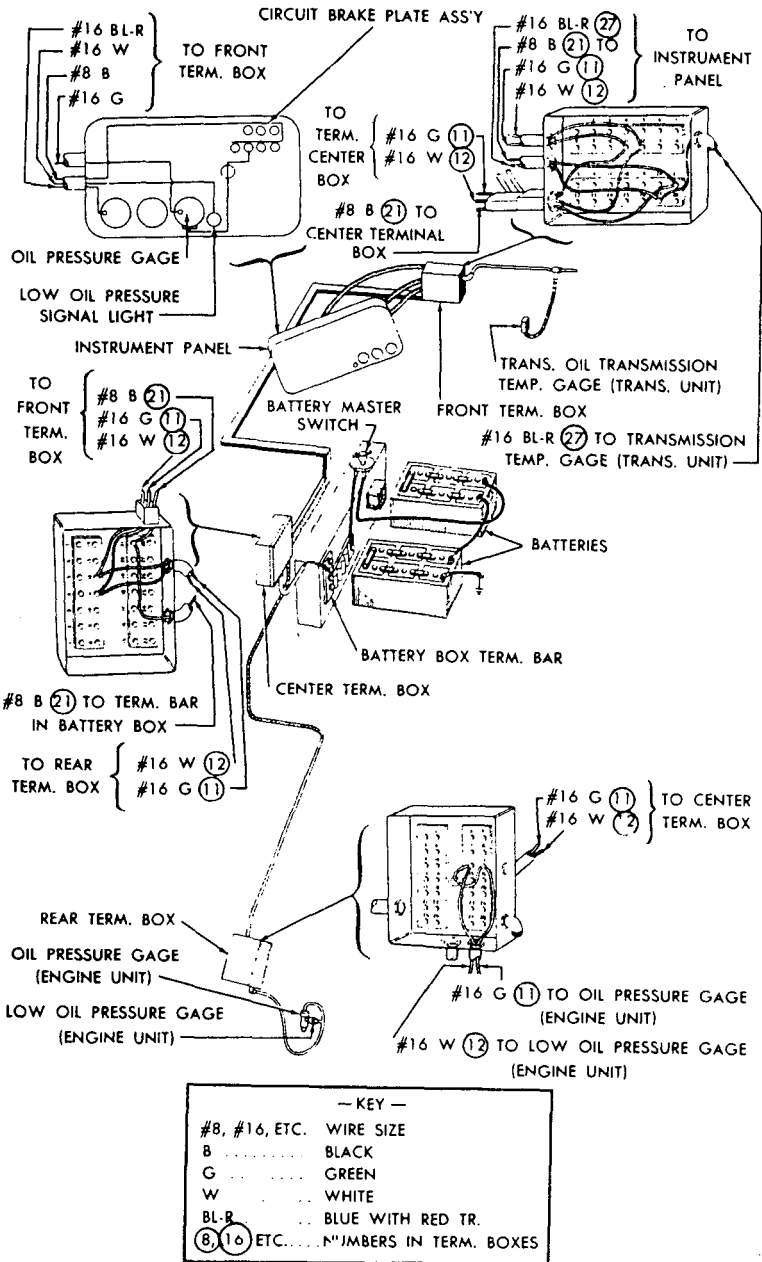

RA PD 329461

Figure 30—Oil Pressure Gage, Low Oil Pressure Signal, and Transmission Oil Temperature Gage Circuits (75-mm Dry Stowage Vehicles)

TROUBLE SHOOTING

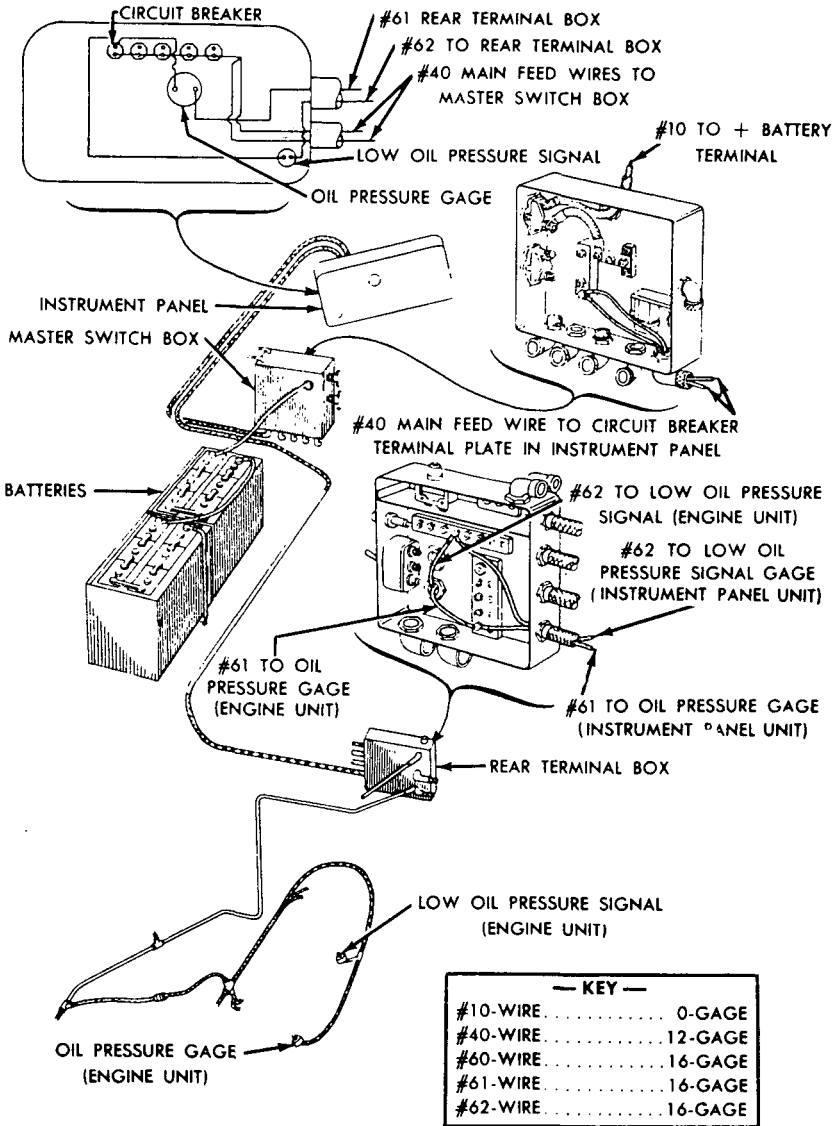

RA PD 329462

Figure 31—Oil Pressure Gage and Low Oil Pressure Signal Circuit (76-mm Wet Stowage, 76-mm, and 105-mm Howitzer Vehicles)

TM 9-759

41-43

TANK, MEDIUM, M4A3

k. **Abnormal Engine Noise.** The following procedure for locating abnormal engine noise applies only if the condition of the engine permits its being run. Set the engine speed at approximately 600 revolutions per minute, and place a neon-type spark tester on one of the spark plug terminals. The neon light will flash with every other revolution of the engine. If the noise occurs twice for each flash, the source is at some point driven by the crankshaft, such as pistons, rings, pins, connecting rod bearings, or main bearings. A loose main bearing knock is usually a dull thud, more noticeable on a hard pull or quick acceleration. If the noise occurs once for each flash, the source is at some point driven by the camshaft, such as valves, push rods, etc. **NOTE:** *Camshaft backlash noise below 500 revolutions per minute is not to be considered abnormal.*

42. IGNITION SYSTEM (fig. 32).

a. **No Spark Delivered to Spark Plugs in Either Right or Left Bank.** If no spark is obtained from a magneto under the test outlined in paragraph 41 b (3), remove the ignition switch wire (ground wire) from whichever magneto does not deliver spark. Crank the engine with the cranking motor. If a satisfactory spark is obtained with the ignition switch wire removed, it will indicate that the ignition switch is faulty, or that the ignition wire extending from the magneto to the switch is short-circuited. Replace the ignition switch or wire, whichever is at fault. If no spark is obtained from this test, the magneto on the side being tested is at fault. Replace magneto (par. 66 b).

b. **No Spark or Unsatisfactory Spark Obtained at Some Spark Plug Wires, and Satisfactory Spark at Other Wires.** Examine all spark plug wires on the side of the engine being tested. Any wires found chafed, or with faulty insulation, must be replaced. If the spark plug wires are in good condition, it can be assumed the distributor plate in the magneto is at fault. Replace the magneto (par. 66 b).

c. **Intermittent Spark at Each Spark Plug Wire.** If an intermittent spark is obtained from each of the spark plug wires, it indicates that the magneto on the side of the engine being tested is at fault. Replace the magneto (par. 66 b).

43. BATTERIES AND GENERATING SYSTEM (figs. 34 and 35)

a. **Batteries Run Down.** Excessive use of electrical accessories must be avoided when the generator is not operating. Be sure the battery master and radio master switch (figs. 7 and 14) are not left on when the vehicle is not in use. Replace the discharged batteries with fully charged units. Disconnect the cable from the

TROUBLE SHOOTING

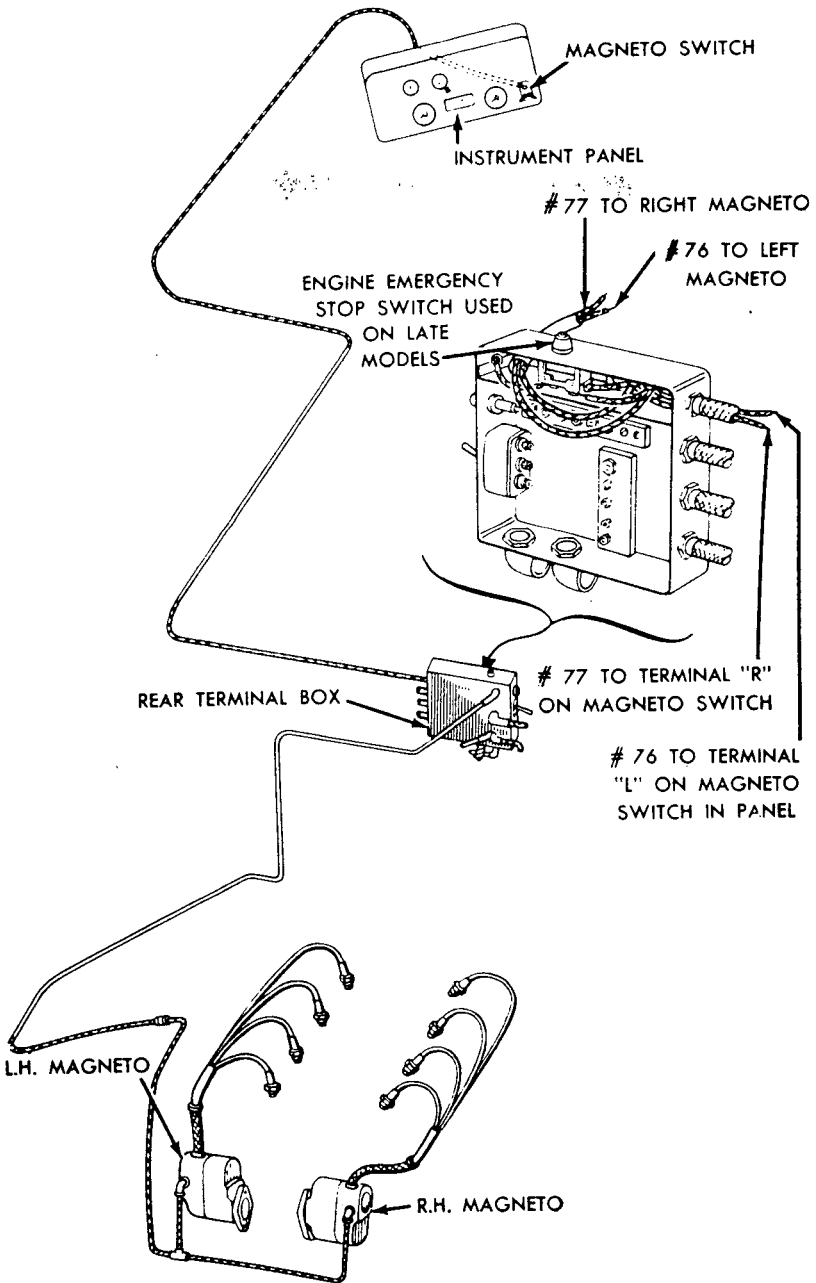

RA PD 329435

Figure 32—Ignition System

TANK, MEDIUM, M4A3

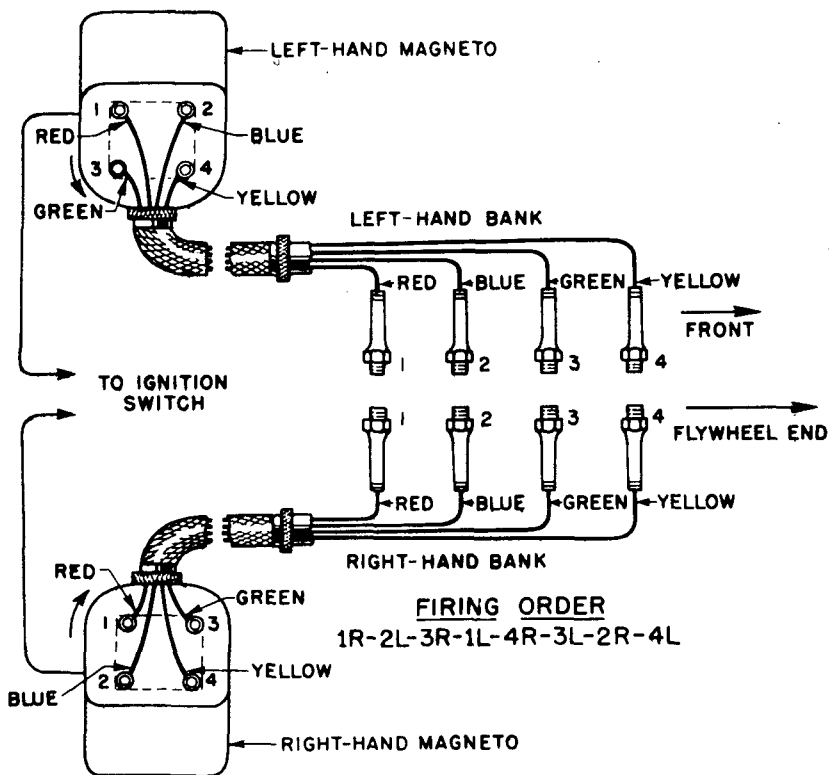

RA PD 27428

Figure 33—Ignition Wiring Diagram

positive terminal of the forward battery. Turn the battery and radio master switches on, and contact the battery cable against the positive post of the battery. If a flash is seen from this test, it will indicate that there is a shorted or grounded wire in the electrical circuits, or that the cut-out points in the generator regulator are stuck together. Refer to subparagraph d (2) below for generator regulator test. If the generator regulator is found satisfactory, it can be assumed the wiring is at fault. Notify higher authority.

b. **Batteries Use Excessive Water.** See subparagraph f below.

c. **Ammeter Does Not Show Charge.** If the ammeter fails show a charge, turn on all lights and observe whether a discharge shown. If no discharge is observed, connect a new ammeter to the leads in the instrument panel. If a reading is obtained, the ammeter is faulty and must be replaced (par. 92 a). If no reading is observed, proceed with the next test (subpar. d below).

TROUBLE SHOOTING

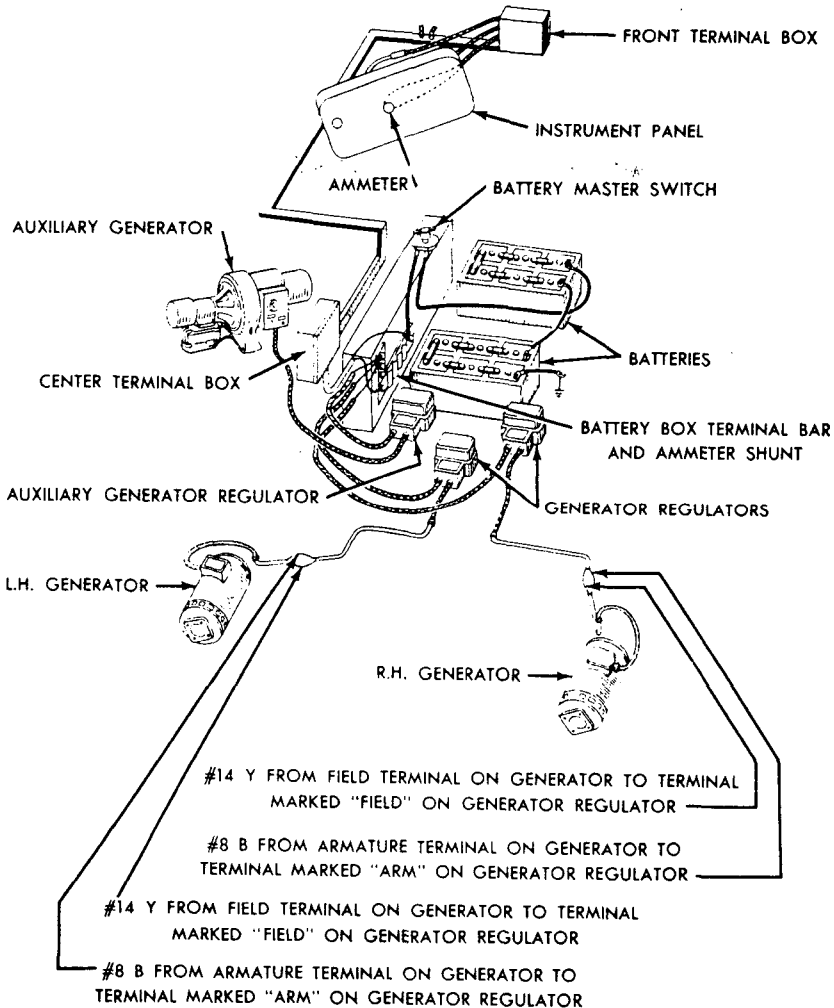

RA PD 329449

Figure 34—Generating System (175-mm Dry Stowage Vehicles)

d. Generator or Generators Do Not Charge the Batteries.

(1) **TEST GENERATOR.** If equipped with two generators, check one generator at a time. Remove the field wire from the generator not being tested. Remove the armature and battery wire from the "ARM" and "BAT" terminals of the generator regulator for the generator being tested, and connect an ammeter between them. Remove the field wire from the field terminal of the regulator. Start

TM 9-759

43

TANK, MEDIUM, M4A3

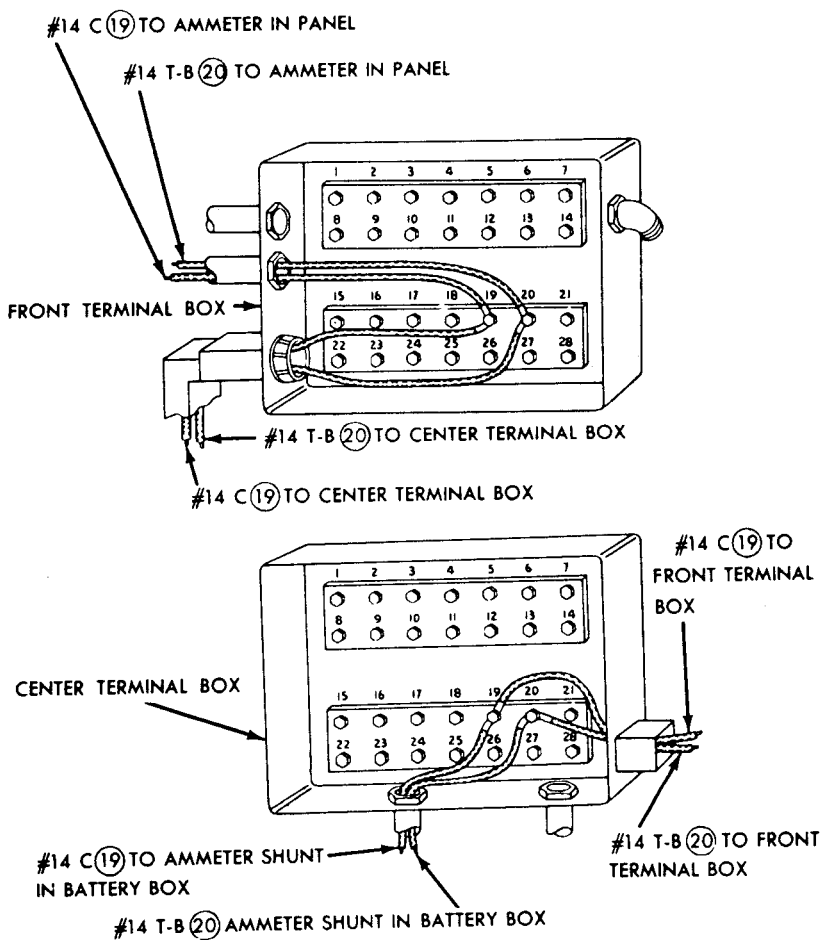

KEY TO ABBREVIATIONS	
C	— CHROME
T-B	— TAN WITH BLACK TRACER
#14	— WIRE SIZE
19/20	— TERMINAL BOX NUMBERS

RA PD 32950

Figure 35—Terminal Box Connections for Generating System (75-mm Dry Stowage Vehicles)

TROUBLE SHOOTING

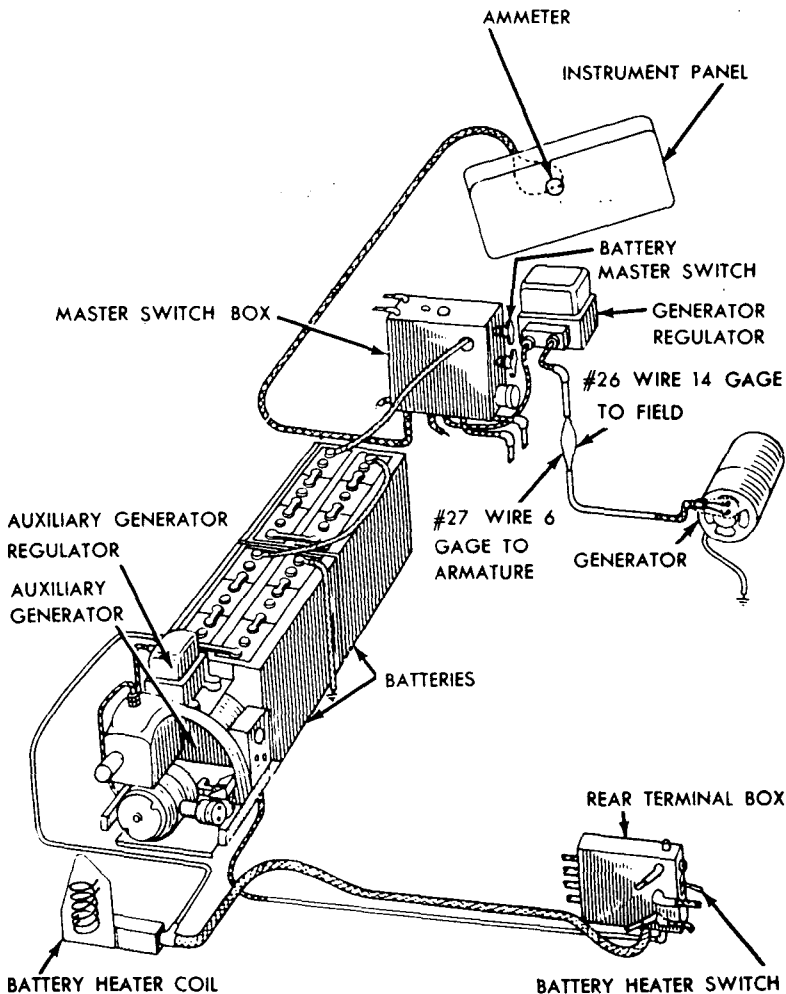

RA PD 329438

Figure 36—Generating System (75-mm Wet Stowage, 76-mm, and 105-mm Howitzer Vehicles)

the engine and while it is running at idle speed, touch the free end of the field wire to the armature wire. Increase the speed of the engine, and note the charging rate. **CAUTION: Do not increase the charge above 50 amperes.** If the charging rate increases as the engine is speeded up, the generator is operating normally. Reconnect the wires to the generator regulator. If the charging rate does not increase, the generator is at fault and must be replaced (par. 102 c).

TANK, MEDIUM, M4A3

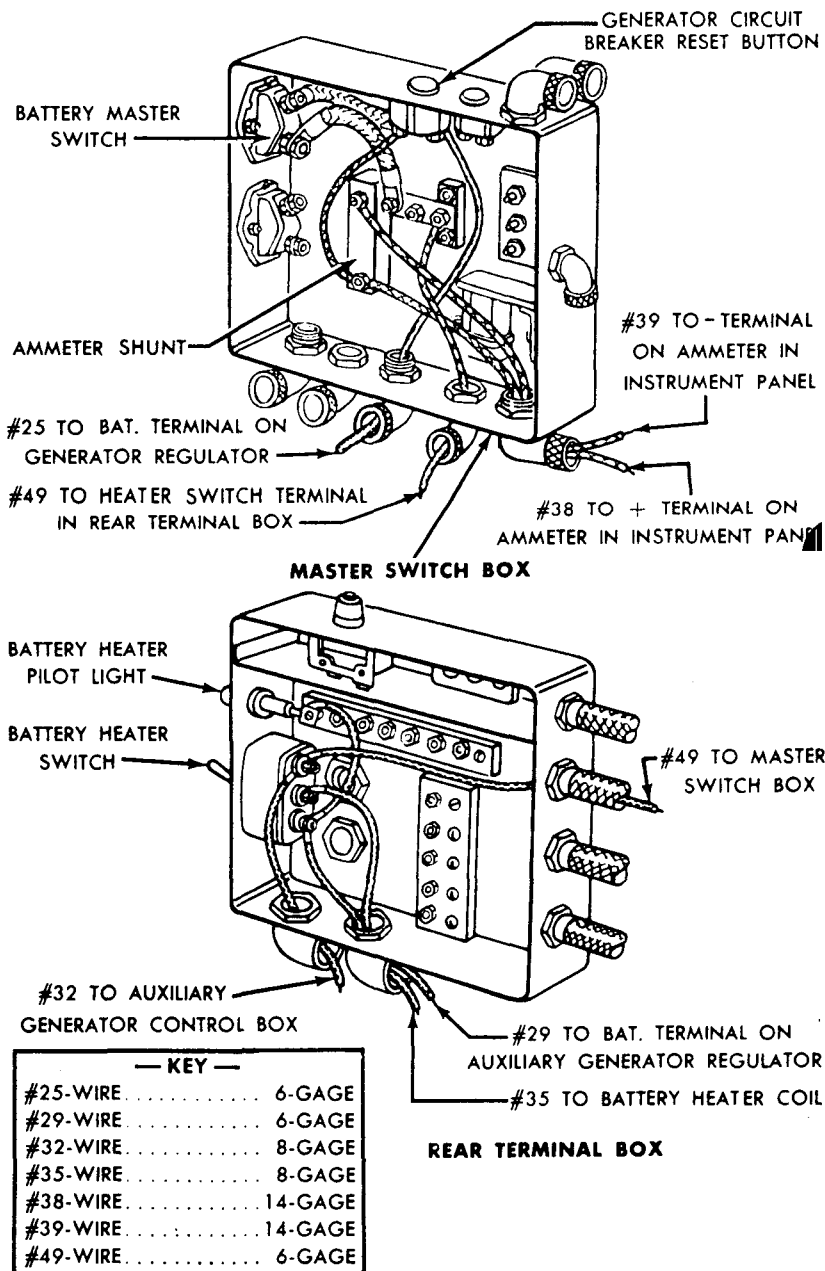

RA PD 329443

Figure 37—Terminal Box Connections for Generating System (75-mm Wet Stowage, 76-mm, and 105-mm Howitzer Vehicles)

TROUBLE SHOOTING

(2) **TEST GENERATOR REGULATOR.** If equipped with two generators, be sure the regulator being tested is in series with the generator circuit being tested. Start the engine and run it at approximately 800 revolutions per minute, observe the ammeter on the instrument panel. If no charging rate is indicated, connect the terminal marked "BAT" and the terminal marked "ARM" together with a jumper wire, and watch the ammeter. If a reading is obtained, the cut-out unit of the regulator is at fault. Replace the generator regulator (par. 104 b). If no reading is obtained, connect the battery and field terminals together with the jumper wire. If a reading is now obtained, the generator regulator is at fault. Replace the generator regulator (par. 104 b).

c. **Low Charging Rate When Batteries Are Low in Charge.** Operate the engine at a speed of 2,500 revolutions per minute. If the charging rate increases to maximum charging rate (50 amperes) then gradually decreases as the battery becomes charged, the generating system is functioning normally. If the charging rate does not increase to maximum, the generator regulator is at fault. Replace the generator regulator (par. 104 b).

f. **High Charging Rate When Batteries Are Fully Charged.** Operate the engine at a speed of 2,500 revolutions per minute. If the generator has replaced the current used by the cranking motor, and the batteries are known to be fully charged, the ammeter shows a charge in excess of 15 amperes, it can be assumed that the voltage setting of the generator regulator is too high. Replace the generator regulator (par. 104 b). *NOTE: If the batteries gas freely and use water excessively, this also is an indication of too high charging rate.*

44. STARTING SYSTEM.

a. **Engine Fails to Turn Over When the Starting Switch is Pressed.**

(1) **TEST BATTERIES.** Test the state of charge of the batteries (par. 39). If the batteries are low in charge, they must be recharged or replaced. Make certain the battery terminals are clean and tight.

(2) **TEST CRANKING MOTOR.** With a jumper wire made from a piece of battery cable, contact the two terminals on the cranking motor relay (the terminals to which the heavy cables are attached). If the cranking motor fails to run, replace the cranking motor (par. 105 b). If the cranking motor does run in this test, proceed with test in step (3) below.

(3) **TEST CRANKING MOTOR RELAY, STARTING SWITCH AND STARTING SWITCH WIRE.** Use a jumper wire and contact it between

TM 9-759

44

TANK, MEDIUM, M4A3

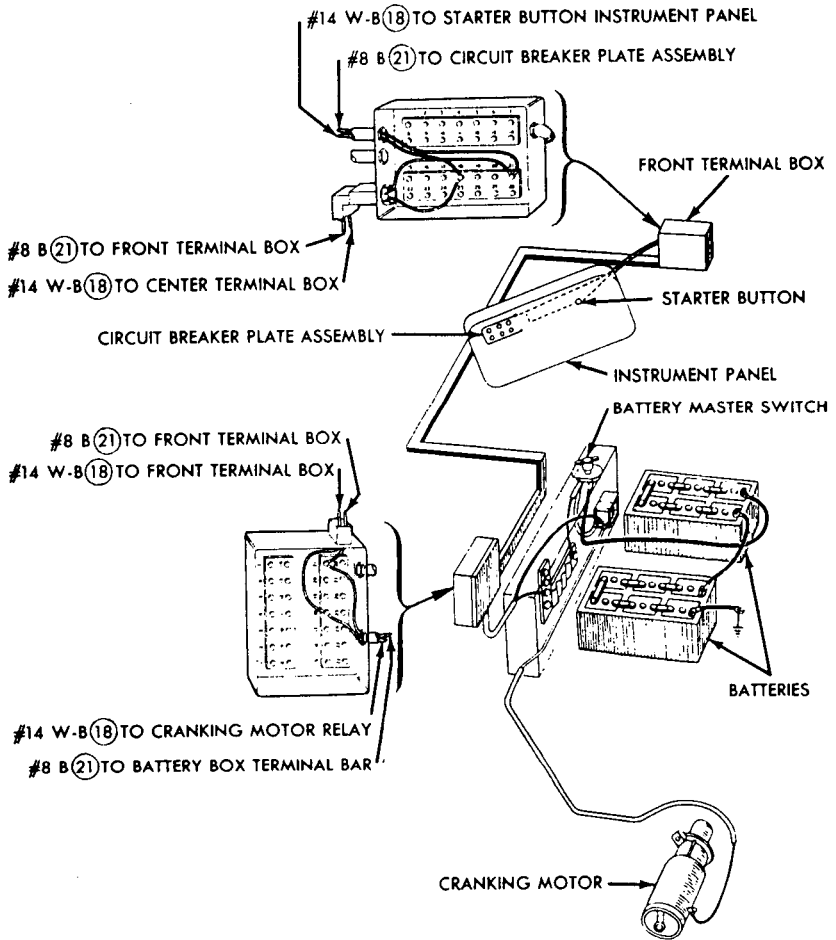

— KEY —

B—BLACK WIRE
W-B—WHITE WITH BLACK TRACER
#8, 16—WIRE SIZE
⑭ ⑱ ETC.—TERMINAL BOX NUMBERS

RA PD 329448

Figure 38—Starting System (75-mm Dry Stowage Vehicles)

TRUBLE SHOOTING

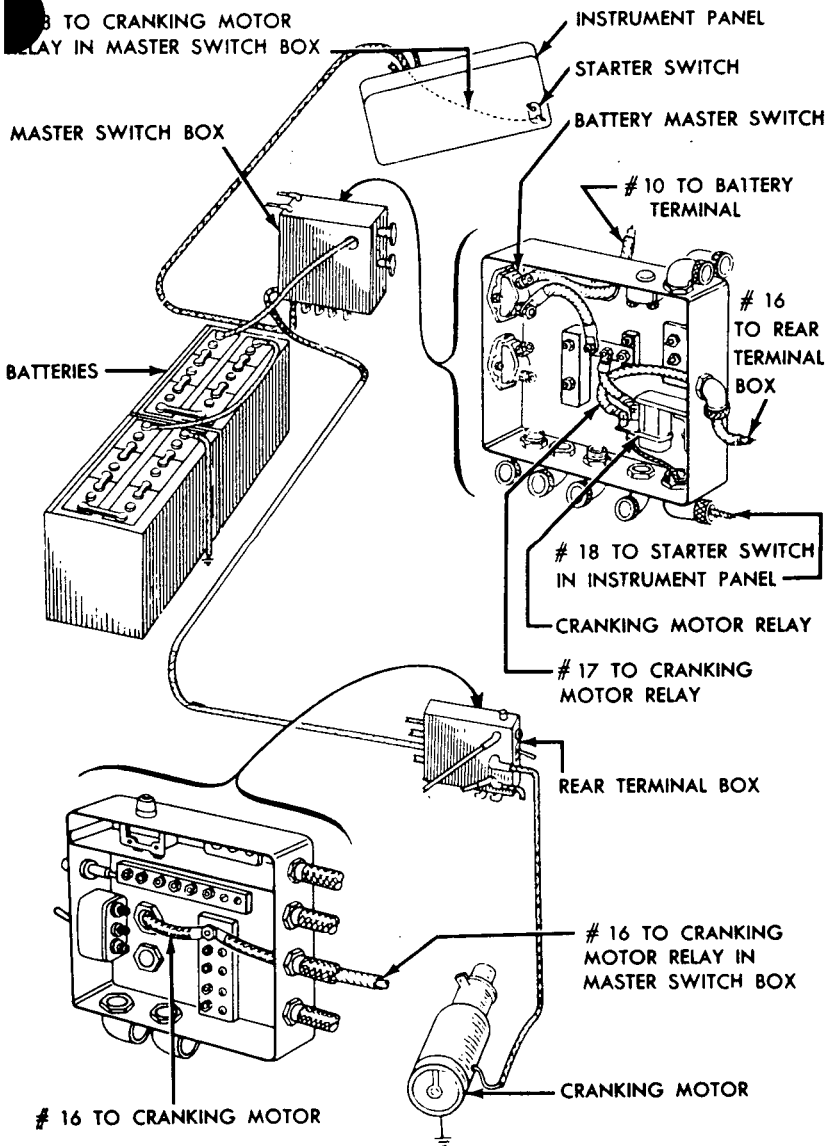

—KEY—

#10 WIRE	0 GAGE
#16 WIRE	0 GAGE
#17 WIRE	0 GAGE
#18 WIRE	16 GAGE

RA PD 329444

Figure 39—Starting System (75-mm Wet Stowage, 76-mm, and 105-mm Howitzer Vehicles)

TANK, MEDIUM, M4A3

the "hot" terminal on the relay and the small terminal at the bottom of the relay to which the small wire (figs. 38 and 39) is attached. If the relay clicks and the cranking motor cranks the engine, the trouble is in the starting switch or the starting switch wiring. Replace the starting switch or the faulty wiring, whichever is at fault. If the cranking motor does not crank the engine in this test, it will indicate that the cranking motor is at fault. Replace the relay (par. 106 b).

45. FUEL SYSTEM.

a. Fuel Not Reaching the Carburetor. Make sure the fuel shut-off valves (figs. 9 and 10) are open and that there is a sufficient fuel supply in the tanks. Clean the fuel filter (on dry stowage vehicles only) (par. 80 a (3)). Remove the outlet fuel line from the fuel pump, and with the ignition switch off, crank the engine with the cranking motor. If a free flow of fuel is not evident, replace the fuel pump (par. 79 b). If a free flow of fuel is obtained in the above test, the fuel system up to the carburetor is satisfactory. If the trouble still exists, replace the carburetor (par. 72 e and f).

b. Engine Runs Unevenly, and Black Smoke Is Emitted From Exhaust. Check the fuel pump pressure (par. 39). If the pressure is too high, replace the fuel pump (par. 79 b). If the pump pressure is satisfactory, run the engine at idle speed, remove the fuel level inspection plug from each carburetor (fig. 89), and observe the fuel level in the carburetors. If the fuel runs from the inspection hole on either carburetor, the fuel level is too high in that carburetor. Replace the carburetor (par. 72 e and f).

c. Fuel Mixture Too Lean. Run the engine at idle speed, and remove the fuel level inspection plug from each carburetor (fig. 89). If the fuel level is below the bottom threads of this hole, the float level is too low, due to incorrect carburetor float setting, or a restriction in the fuel lines or the fuel filter. Remove any restriction to a free flow of fuel. Check the fuel pump pressure (par. 39). If the pressure is low, replace the fuel pump (par. 79 b). If this does not correct the low level, replace the carburetor (par. 72 e and f).

d. Engine Slows Down But Does Not Stop When Fuel Cut-off Button Is Pressed. Press the fuel cut-off circuit breaker button at the top of the instrument panel. On earlier vehicles where the degasser wires are not shielded at the carburetors, make sure that the plug connector at each degasser is tight. Start the engine and turn the ignition switch to the "R" position which will cause the engine to run on the right bank of cylinders. Press the fuel cut-off button. Turn the ignition switch to the "L" position and press the fuel cut-off button. The bank of cylinders which continue to fire after the fuel

TROUBLE SHOOTING

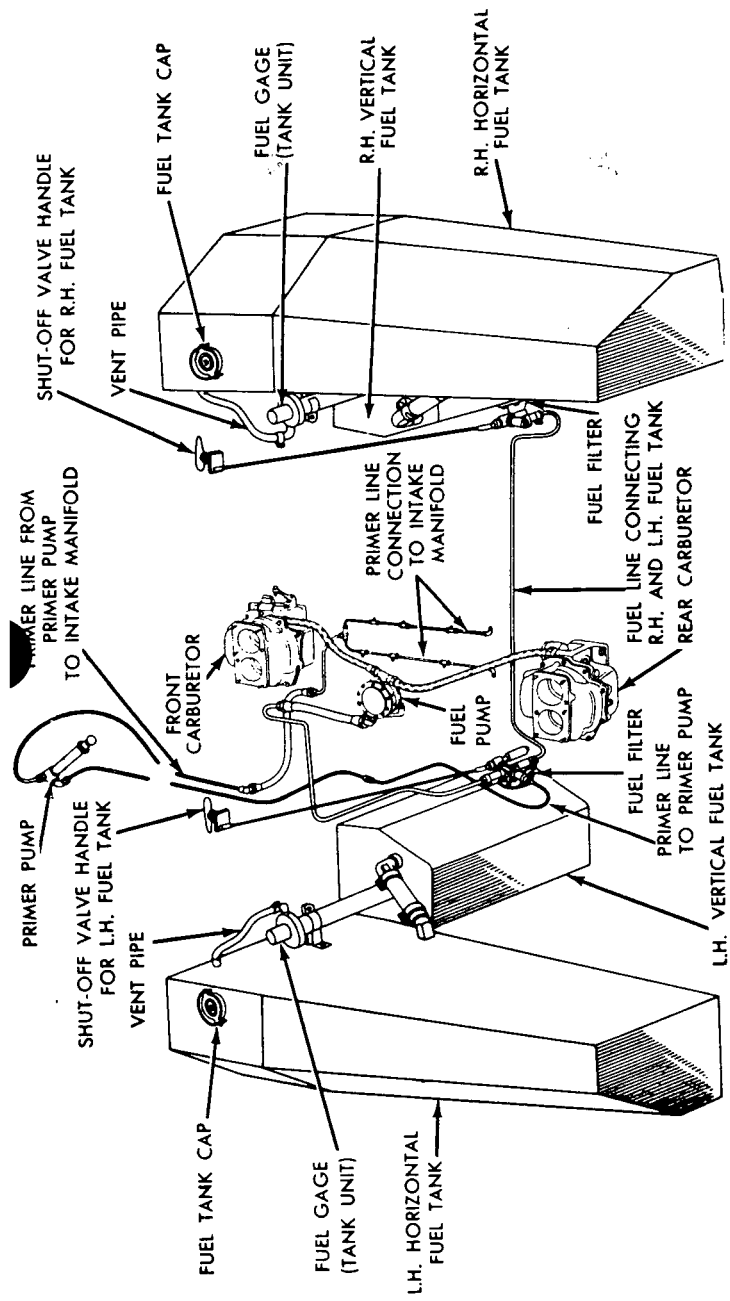

RA PD 329454

Figure 40—Fuel System (175-mm Dry Storage Vehicles)

TANK, MEDIUM, M4A3

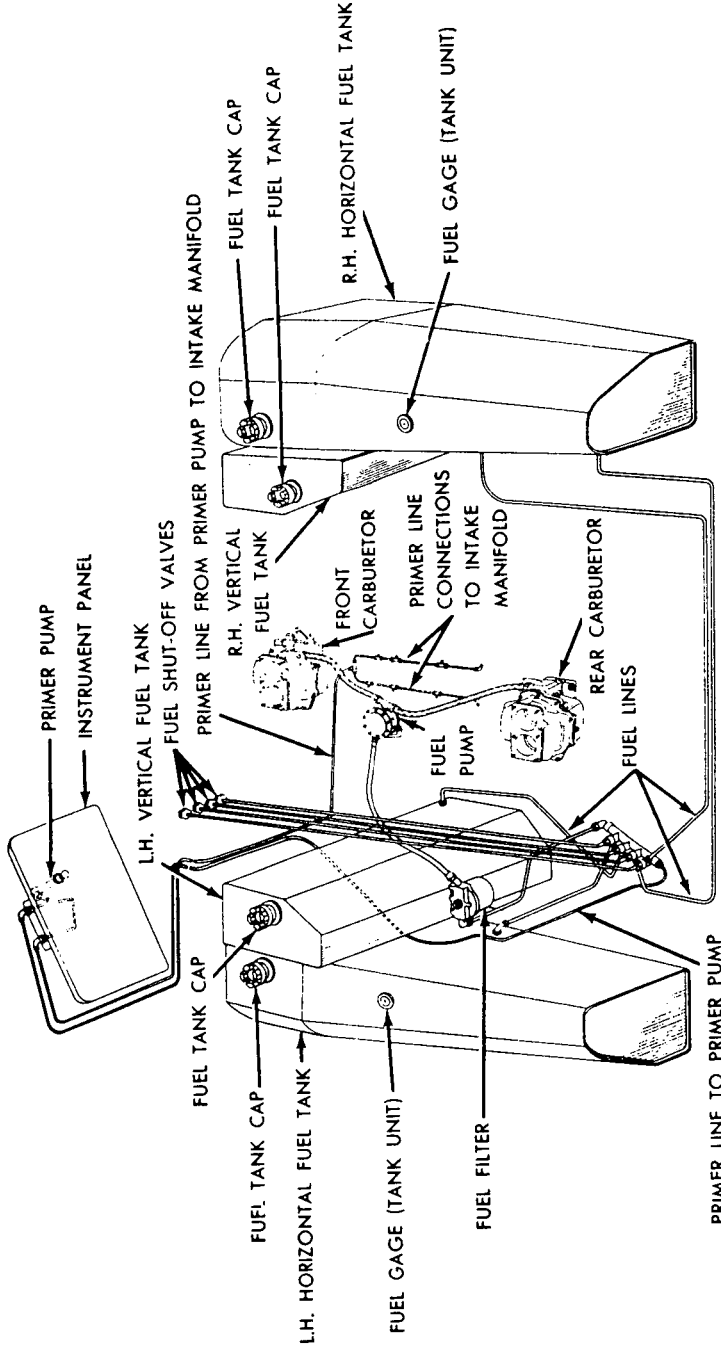

RA PD 329455

Figure 41—Fuel System (75-mm Wet Stowage, 76-mm and 105-mm Howitzer Vehicles)

TROUBLE SHOOTING

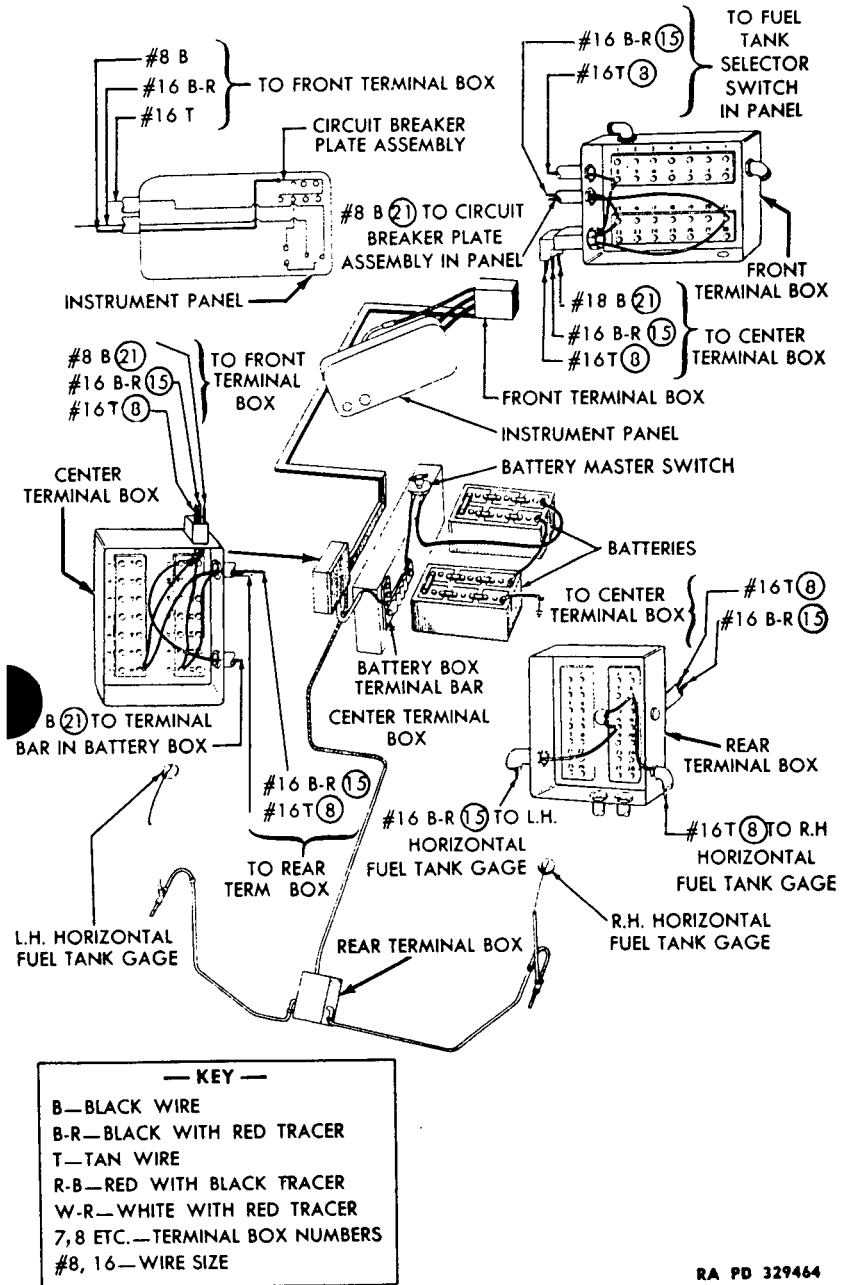

RA PD 329464

TANK, MEDIUM, M4A3

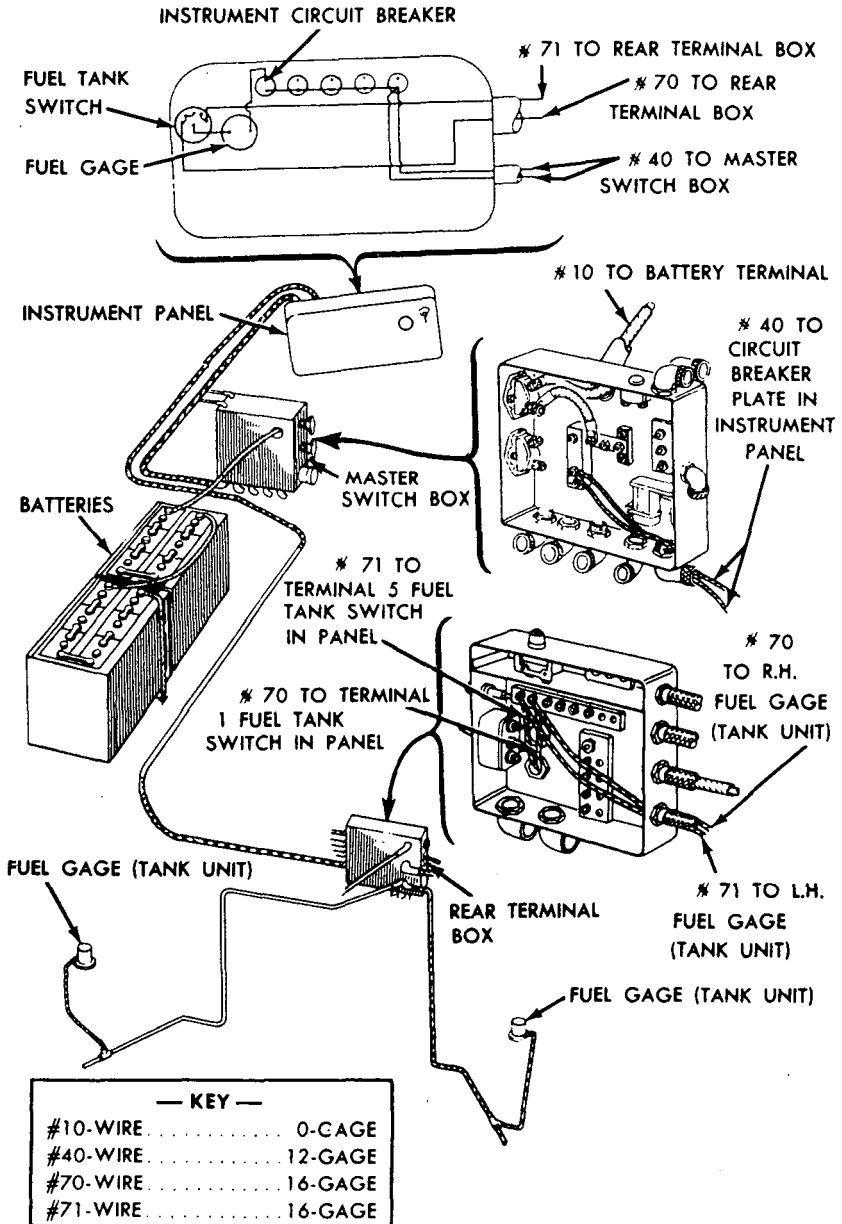

RA PD 329465

Figure 43—Fuel Gage Circuit (175-mm Wet Stowage, 76-mm, and 105-mm Howitzer Vehicles)

TROUBLE SHOOTING

Fuel cut-off button is pressed will show that either one of the degassers on the side of the engine is defective. To determine which one of the two suspected degassers is at fault, close the idling adjusting screw in the rear carburetor on the side which supplies fuel to whichever bank of cylinders continue to fire after the fuel cut-off button is pressed. Run the engine and if the engine stops when the fuel cut-off button is pressed, the defective degasser is in the rear carburetor. If the engine does not stop when the fuel cut-off button is pressed, the defective degasser is in the front carburetor. Replace the degasser (par. 73 b).

e. **Pressing the Fuel Cut-off Button Has No Effect on Engine.** Press the fuel cut-off circuit breaker button at the top of the instrument panel. If the circuit breaker will not stay in contact, check for grounded wire in the degasser circuit. Remove the fuel cut-off button from the instrument panel. Start the engine and connect the two wires running to the button together. If engine stops, the fuel cut-off button is defective.

46. COOLING SYSTEM.

a. **General Instructions.** Difficulties in the cooling system are usually reflected in loss of coolant from the system and overheating. When overheating is evident and the cooling system inspection procedure in subparagraph d below fails to locate the cause, follow instructions as outlined in paragraph 41 h.

b. **Engine Overheats.** Refer to paragraph 41 h.

c. **Engine Runs Too Cold.** Replace the thermostat (par. 88).

d. **Loss of Coolant.**

(1) **INSPECT HOSE CONNECTIONS AND EXTERNAL GASKETS.** Inspect all hose and hose connections, and tighten or replace hose. Inspect for leakage at drain plug (fig. 78) and tighten or replace if required. Inspect external gaskets for leaks, and replace any gaskets found leaking.

(2) **INSPECT WATER PUMP.** If water is leaking from the drilled hole at the bottom of the water pump, it indicates that the pump shaft seal is leaking. Replace the water pump (par. 85 c and d).

(3) **INSPECT PRESSURE FILLER CAP.** With the engine at normal operating temperature, loosen the pressure filler cap at the top of the expansion tank (fig. 100) by turning the cap counterclockwise to the first notch, and listen for pressure escaping from the cooling system. If the pressure is audible, the filler cap is functioning properly. If no pressure is escaping, the filler cap or gasket is at fault. Replace upper and lower gaskets, run the engine until it is again at

TANK, MEDIUM, M4A3

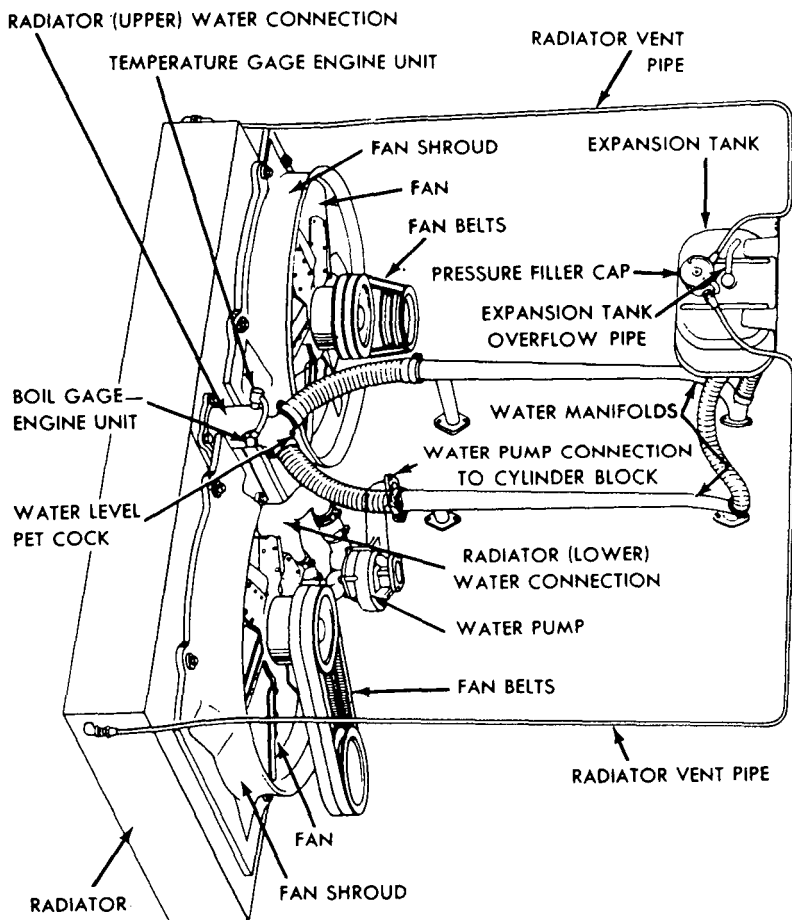

RA PD 329238

Figure 44—Cooling System

operating temperature, and repeat the test. If the new gaskets failed to correct the condition, replace the filler cap.

(4) **INSPECT RADIATOR.** Clean the exterior of the radiator core, remove all grease, dirt, and insects. Inspect the radiator for leaks. If it is found leaking, replace the radiator (par. 84 b and c).

(5) **INSPECT FOR INTERNAL WATER LEAKS.** If the cooling system still loses coolant, drain the oil from the engine oil pan and observe whether there is water in the oil. If an abnormal amount of water is found in the oil, it will indicate an internal water leak in the engine. Notify higher authority. Remove all spark plugs, and,

TROUBLE SHOOTING

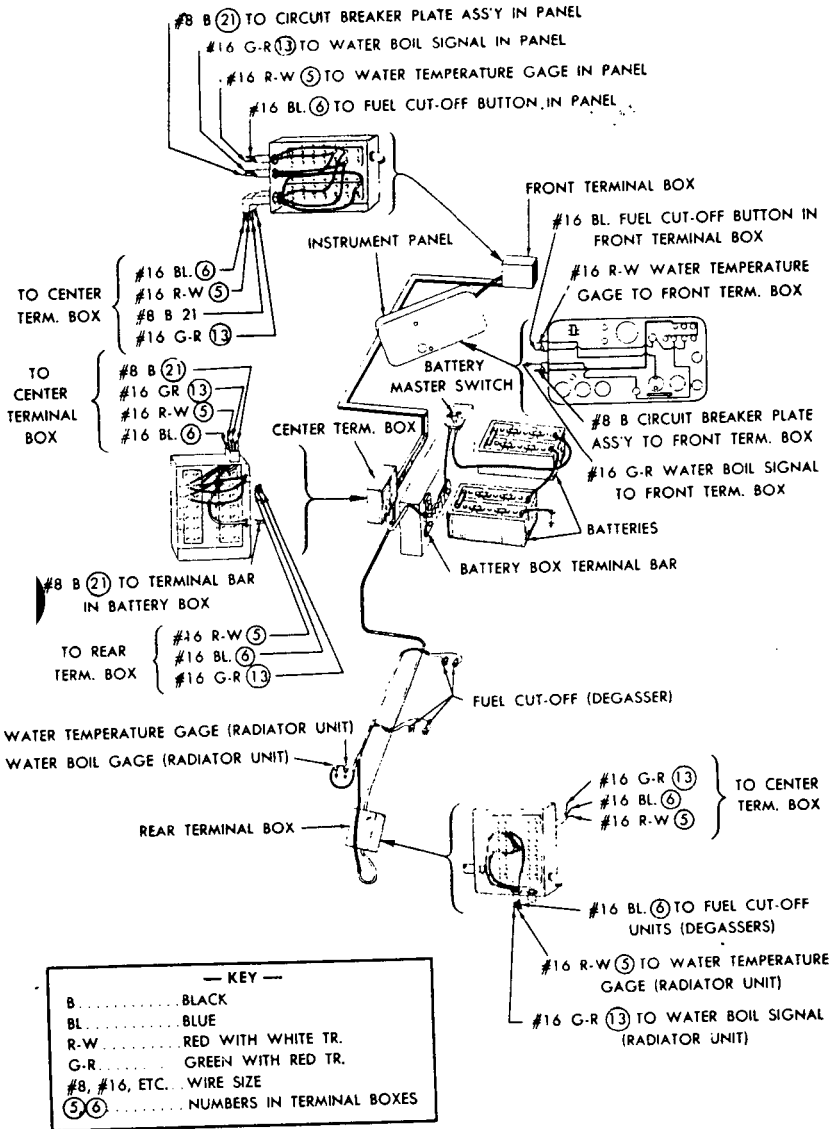

RA PD 329463

Figure 45—Water Temperature Gage, Boil Signal, and Fuel Cut-off (175-mm Dry Stowage Vehicles)

TANK, MEDIUM, M4A3

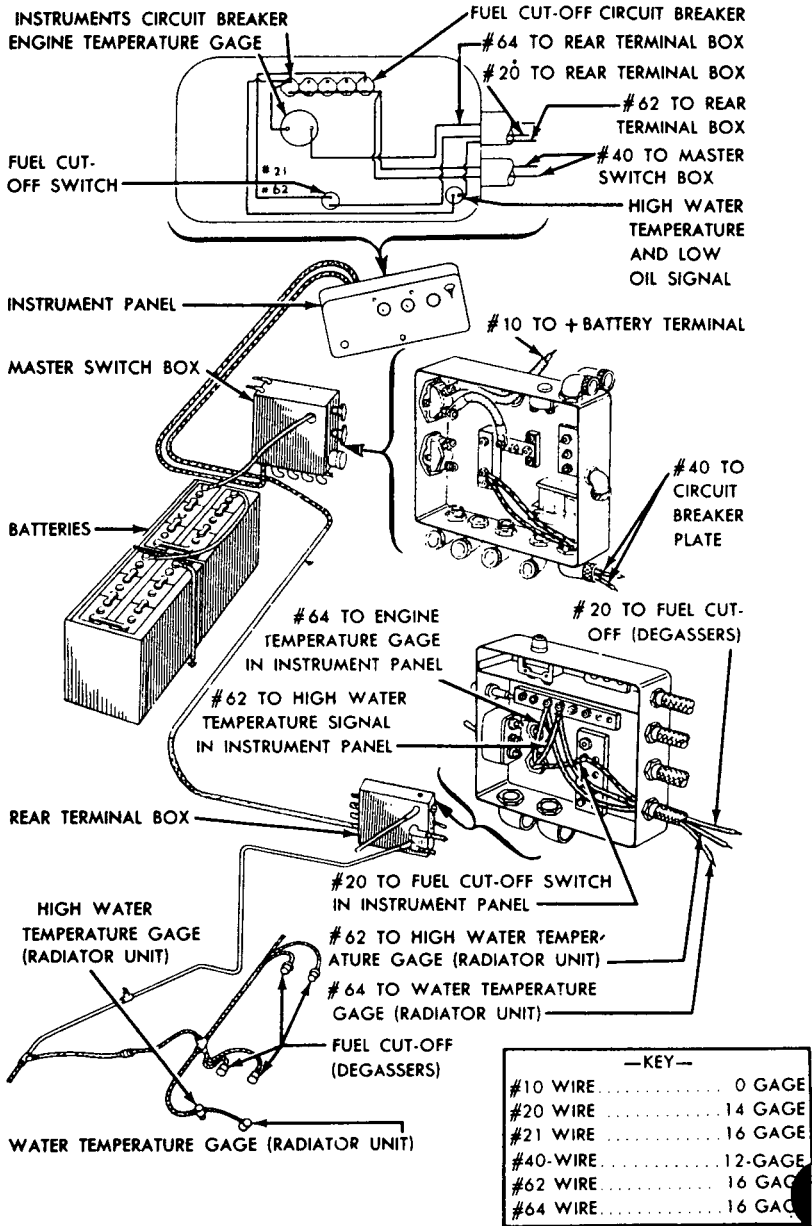

RA PD 329437

Figure 46—Water Temperature Gage, Boil Signal, and Fuel Cut-off (75-mm Wet Stowage, 76-mm, and 105-mm Howitzer Vehicles)

TROUBLE SHOOTING

With the ignition switch off, crank the engine with the cranking motor, and observe if water is evident at the spark plug holes. If water is evident, it can be assumed the cylinder head gaskets are leaking. Replace the cylinder head gaskets (par. 58 b and c).

47. LIGHTS.

a. No Lamps Will Light and No Electrical Units Will Operate.

(1) **PRELIMINARY TEST.** Turn the battery master switch on. Push all the circuit breaker reset buttons located on the instrument panel (figs. 12 and 13). Test the state of charge of the batteries. If the batteries are discharged, they must be recharged or replaced. Clean and tighten the battery terminals securely. If the lamps still fail to light, press the starting switch. If the cranking motor fails to turn, test the battery master switch (step (2) below). If the cranking motor turns, omit test step (2) below and proceed with step (3) below.

(2) **TEST BATTERY MASTER SWITCH** (figs. 7 and 14). Remove the cover from the battery master switch box. Turn the light switch on. Use a jumper wire, and contact across the terminals of the battery master switch (24-volt switch). If the lamps now light, replace the battery master switch.

(3) **TEST CIRCUIT BREAKER.** Disassemble the instrument panel (pars. 90 b or 91 b). Turn the light switch on. Use a jumper wire and contact across the terminals on the circuit breaker marked "LIGHTS." If the lamps now light, the circuit breaker is at fault, and must be replaced. If the circuit breaker fails to stay in contact (kicks out) check the light circuit for grounded or shorted wires. If the lamps still fail to light, proceed with step (4) below.

(4) **TEST MAIN FEED WIRES TO INSTRUMENT PANEL.** Turn the instrument light switch on. If the instrument panel lights come on, the main feed wire circuit is complete. Proceed with the test in step (5) below. If the panel lights do not come on and the lamps are known not to be burned out, it will indicate that the current is not being delivered to the instrument panel.

(a) *Wet Stowage and 105-mm Howitzer Vehicles.* On wet stowage and 105-mm howitzer vehicles, remove the instrument panel and check the connections where the two No. 40 wires are attached to the bus bar on the circuit breaker (figs. 101 and 102). Remove the cover from the battery master switch box and check the terminal of the two No. 40 wires. If this circuit is still unsatisfactory and there is no indication of damage to the conduits which carry these wires, proceed with the test in step (5) below.

(b) *Dry Stowage 75-mm Vehicles.* On dry stowage vehicles with 75-mm gun, remove the instrument panel and check the connection

TANK, MEDIUM, M4A3

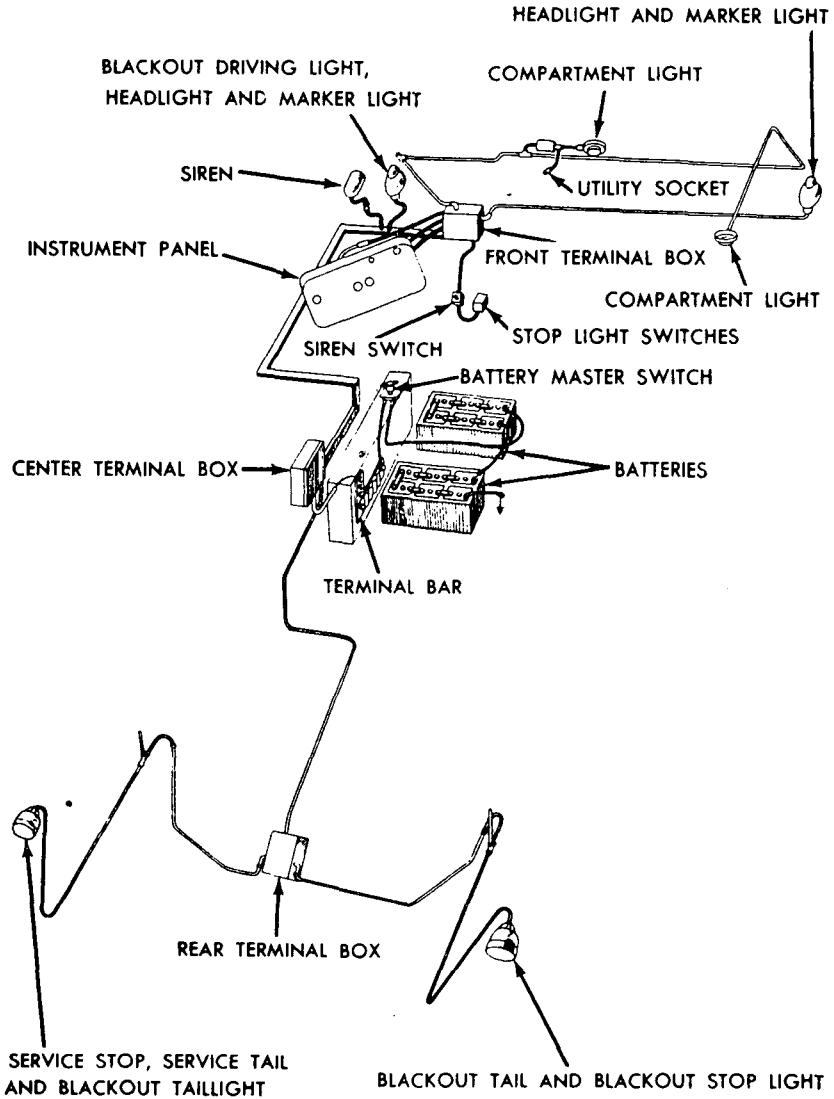

RA PD 329447

Figure 47—Lights and Siren Circuit (175-mm Dry Storage Vehicles)

TROUBLE SHOOTING

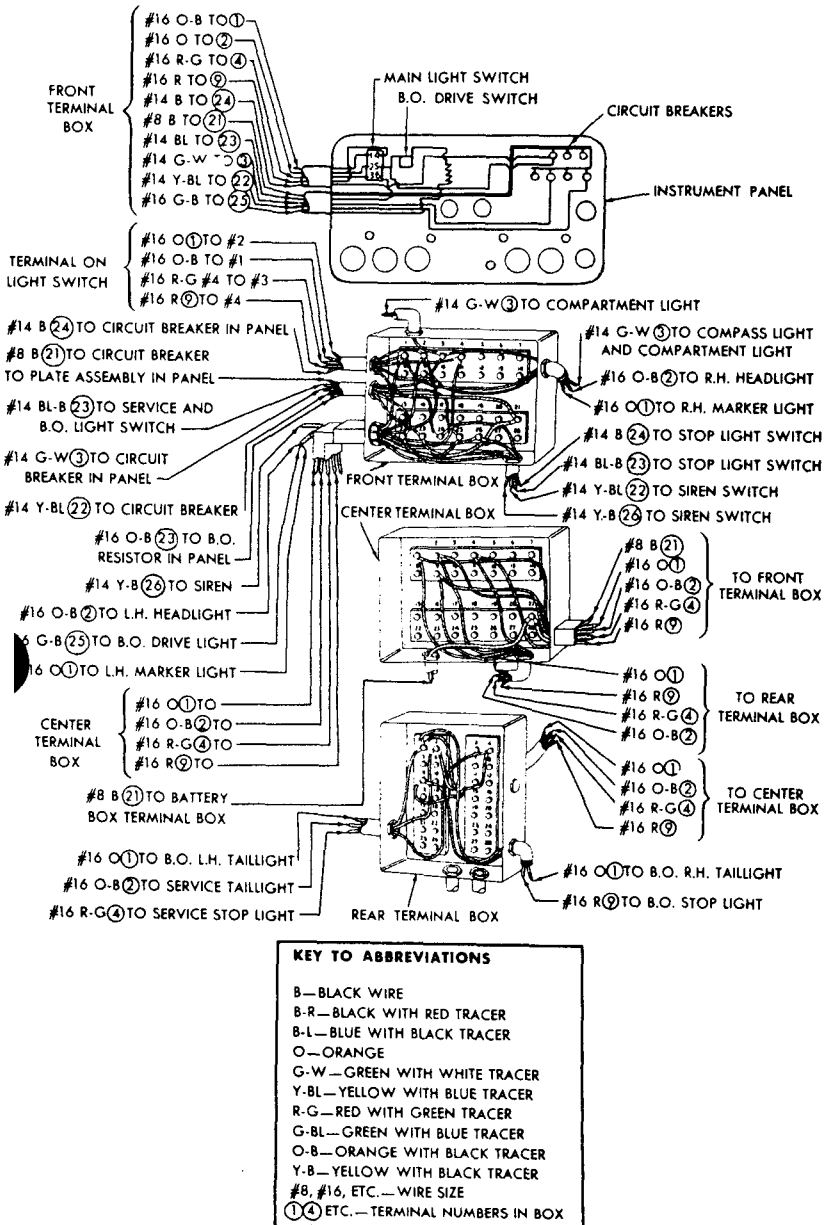

RA PD 329529

Figure 48—Instrument Panel and Terminal Box Connections for Lights and Siren Circuit (175-mm Dry Stowage Vehicles)

TANK, MEDIUM, M4A3

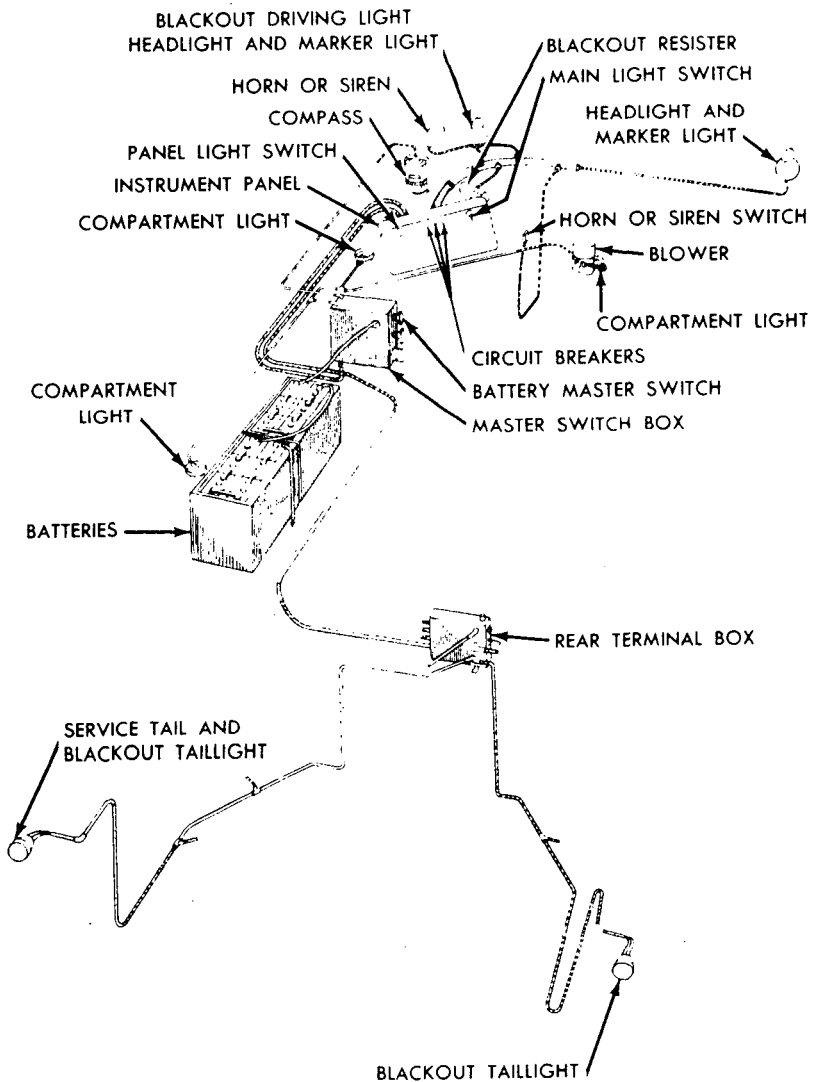

RA PD 329436

Figure 49—Lights, Blower, and Horn or Siren Circuit (75-mm Wet Stowage, 76-mm, and 105-mm Howitzer Vehicles)

TROUBLE SHOOTING

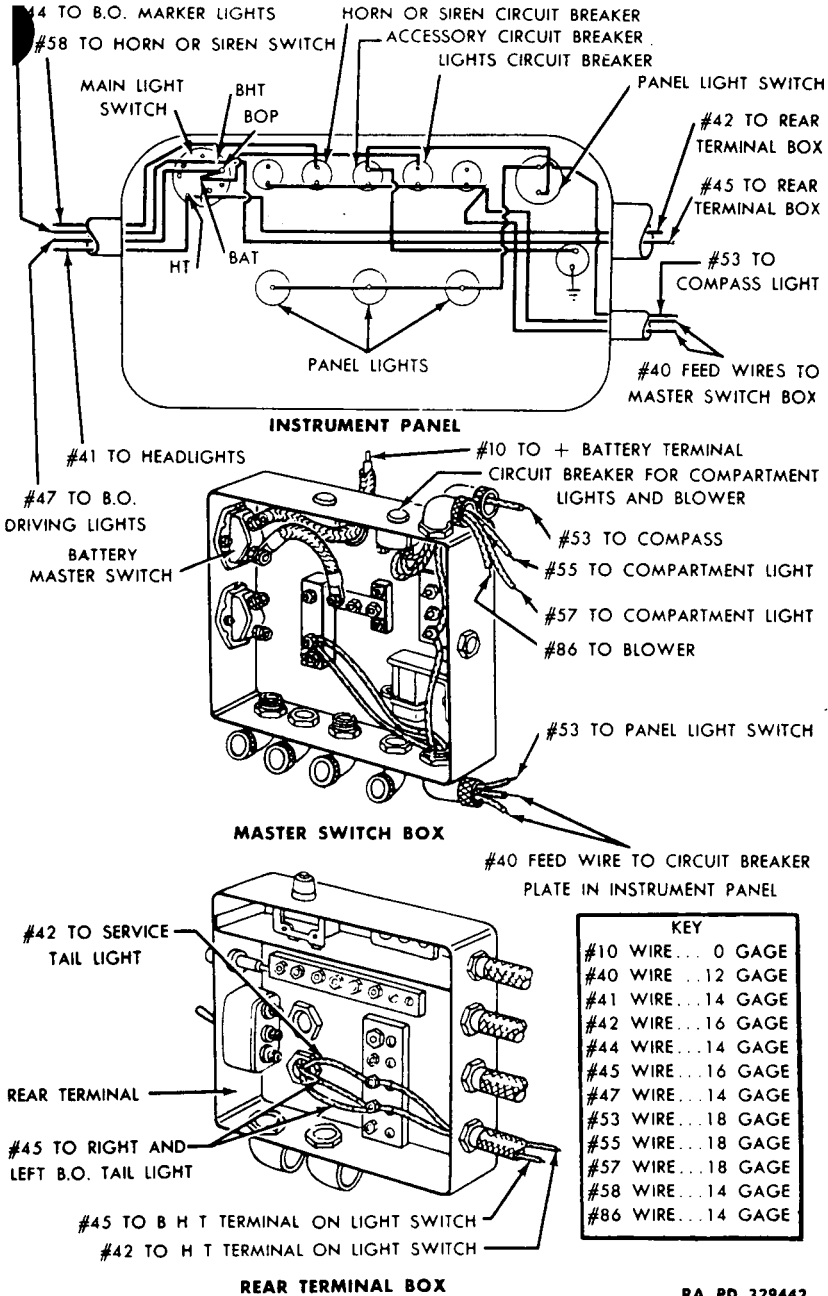

RA PD 329442

Figure 50—Instrument Panel and Terminal Box Connections for Lights, Blower, and Horn or Siren Circuit (75-mm Wet Stowage, 76-mm, and 105-mm Howitzer Vehicles)

TANK, MEDIUM, M4A3

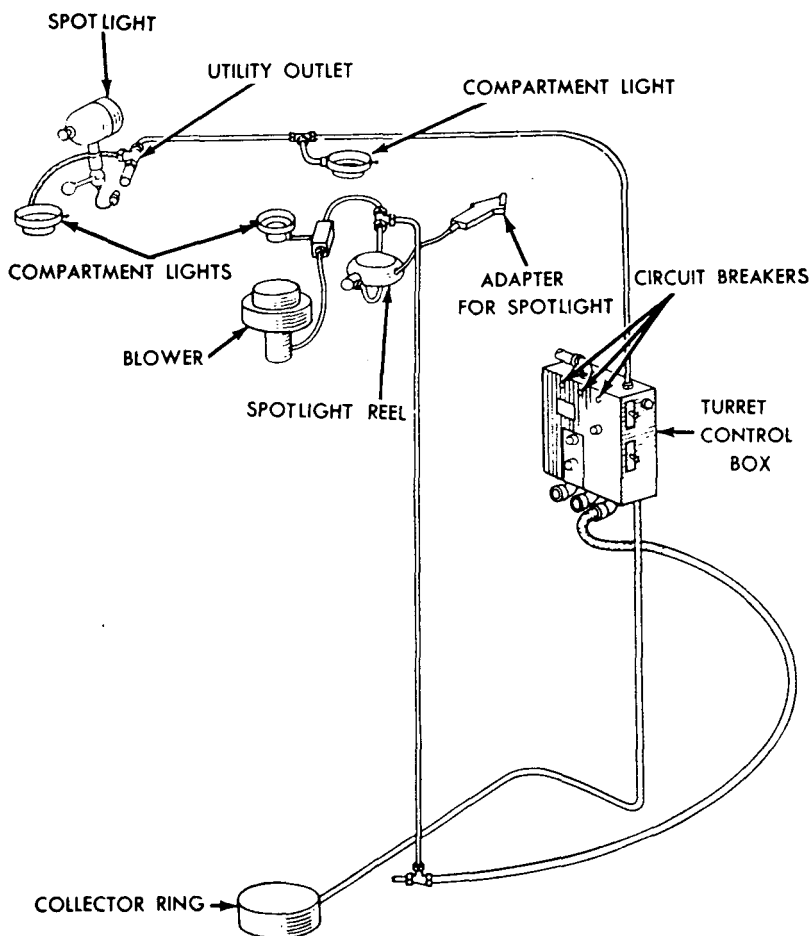

RA PD 329441

Figure 51—Turret Lights and Blower Circuit (76-mm Vehicles)

where the No. 8 gage black wire is attached to the bus bar on the circuit breakers, (fig. 101). Remove the cover from the battery box, and check the terminal where this No. 8 gage black wire is attached to the terminal bar. If this circuit is still unsatisfactory and there is no indication of damage to the conduit in which this wire is carried proceed with test in step (5) below.

(5) **TEST AMMETER SHUNT FOR LOOSE CONNECTIONS.** Remove the cover from the battery master switch box and tighten any connections found loose on the ammeter shunt and terminal bar (fig. 37).

TROUBLE SHOOTING

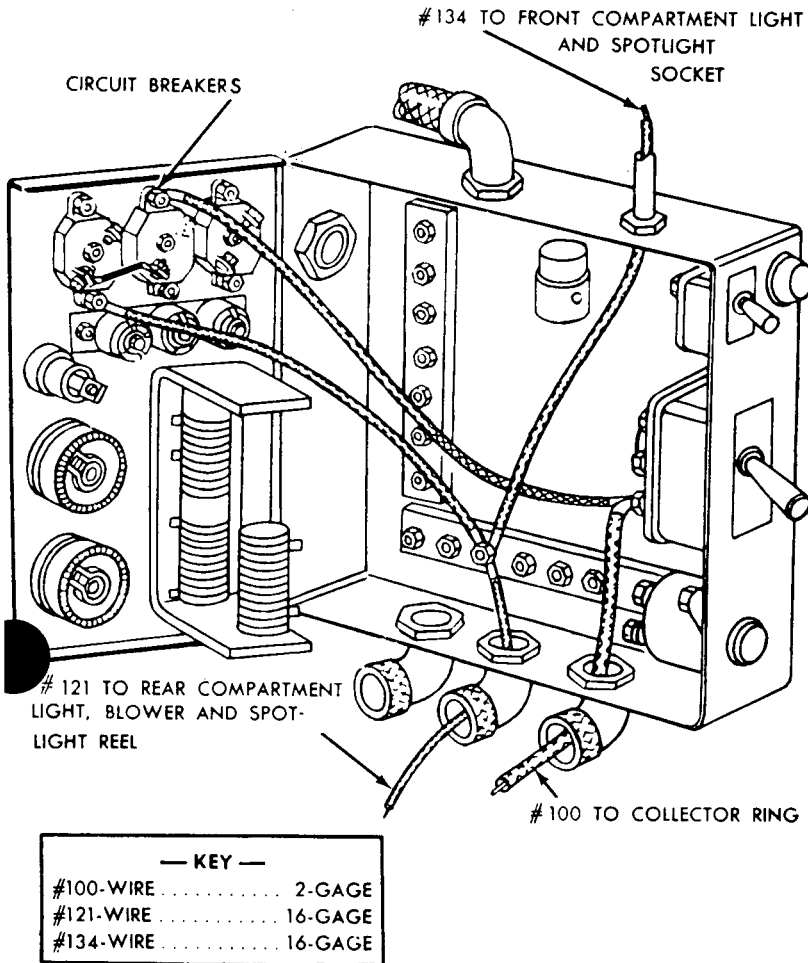

RA PD 329458

Figure 52—Terminal Box Connections for Turret Lights and Blower Circuit (76-mm Vehicles)

On the dry stowage vehicle with the 75-mm gun, the ammeter shunt is located in the battery box (fig. 113).

b. Instrument Panel Lamps Light But No Other Lamps Will Light. Remove the instrument panel and test the circuit breaker marked "LIGHTS" (subpar. a (3) above). On wet stowage and 105-mm howitzer vehicles, examine the wire marked "50" which extends from the circuit breaker marked "LIGHTS" to the terminal marked

TM 9-759

47

TANK, MEDIUM, M4A3

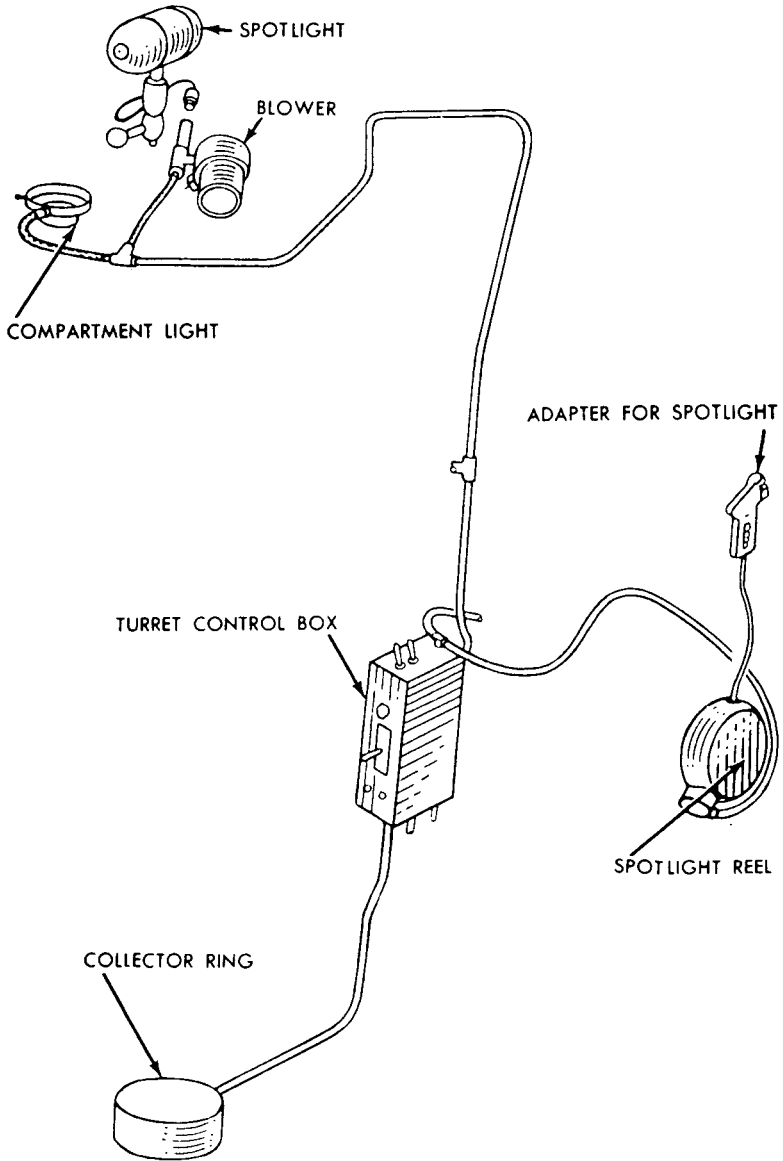

RA PD 329439

Figure 53—Turret Lights and Blower Circuit (75-mm Wet Stowage Vehicles)

TROUBLE SHOOTING

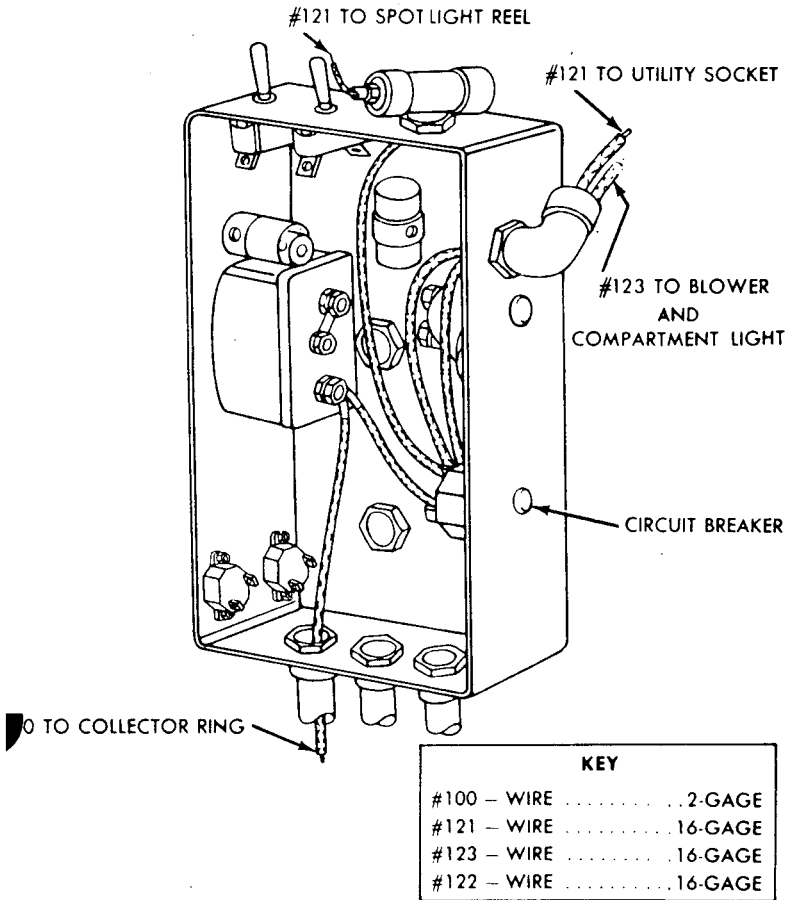

RA PD 329459

Figure 54—Terminal Box Connections for Turret Lights and Blower Circuit (75-mm Wet Stowage Vehicles)

“BAT” on the light switch (fig. 102). If this wire is in good condition and the terminals are tight, it may be assumed that the light switch is at fault and it must be replaced. On dry stowage vehicles with 75-mm gun, remove the instrument panel and test the circuit breaker marked “LIGHTS” (subpar. a (3) above). Examine the black with blue tracer wire which extends from the circuit breaker marked “LIGHTS” to the terminal marked “SS” on the light switch. If this wire is in good condition and the terminals are tight, it may be assumed that the light switch is at fault and must be replaced.

c. **Individual Lamps Do Not Light.** Check any lamps burned out and replace (pars. 98 and 99). Check for loose connections at

TANK, MEDIUM, M4A3

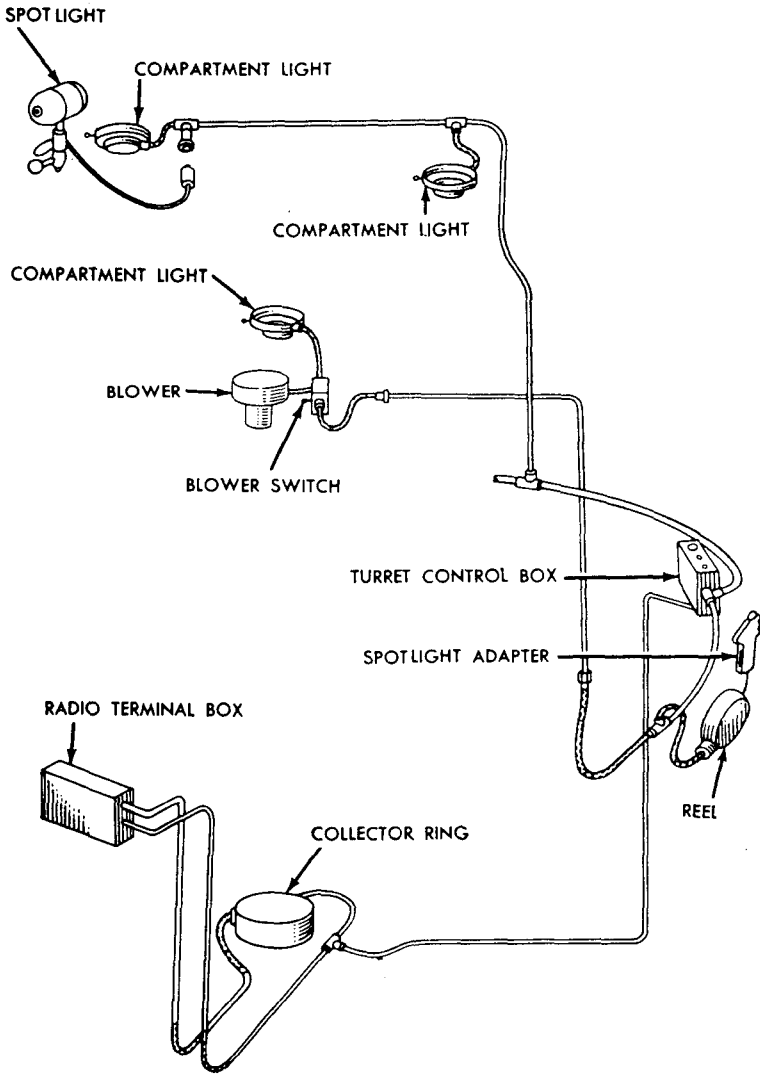

RA PD 329440

Figure 55—Turret Lights and Blower Circuit (105-mm Howitzer Vehicles)

TROUBLE SHOOTING

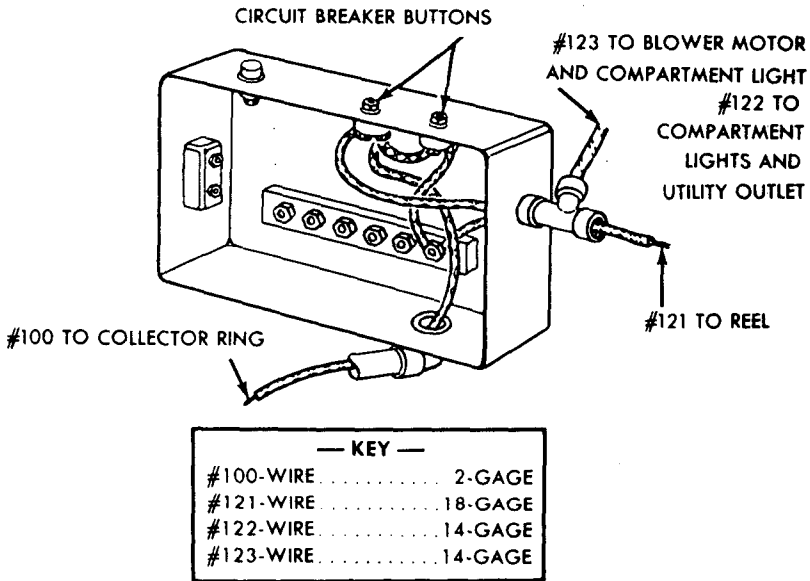

RA PD 329456

Figure 56—Terminal Box Connections for Turret Lights and Blower Circuit (105-mm Howitzer Vehicles)

lights, and tighten connections. Check for damaged wires to the individual unit giving trouble. If the lamp still fails to light, replace the light switch.

d. **One or More Lamps Burn Out Repeatedly.** Most lamp failures are due to vibration when the vehicle is operated over rough terrain. These failures occur more frequently in 12- and 24-volt systems than they do in a 6-volt system, due to the smaller lamp filament used with higher voltages. Clean and tighten all connections, including the battery cable connections, and replace all broken ground straps (bond straps). If the generator has replaced the current used in starting the engine, the batteries are known to be fully charged, and the ammeter shows a charge in excess of 15 amperes, it can be assumed that the voltage setting of the generator regulator is too high. Replace the generator regulator.

e. **Short Circuits or Grounded Wires (Circuit Breaker Marked "LIGHTS" Kicks Out).** Turn the light switch to the blackout marker light position. If the circuit breaker kicks out, it indicates that the shorted or grounded wire is in the blackout marker light or the blackout taillight wires. Turn the light switch to the headlight position. If the circuit breaker kicks out, it indicates that the shorted

TM 9-759

47

TANK, MEDIUM, M4A3

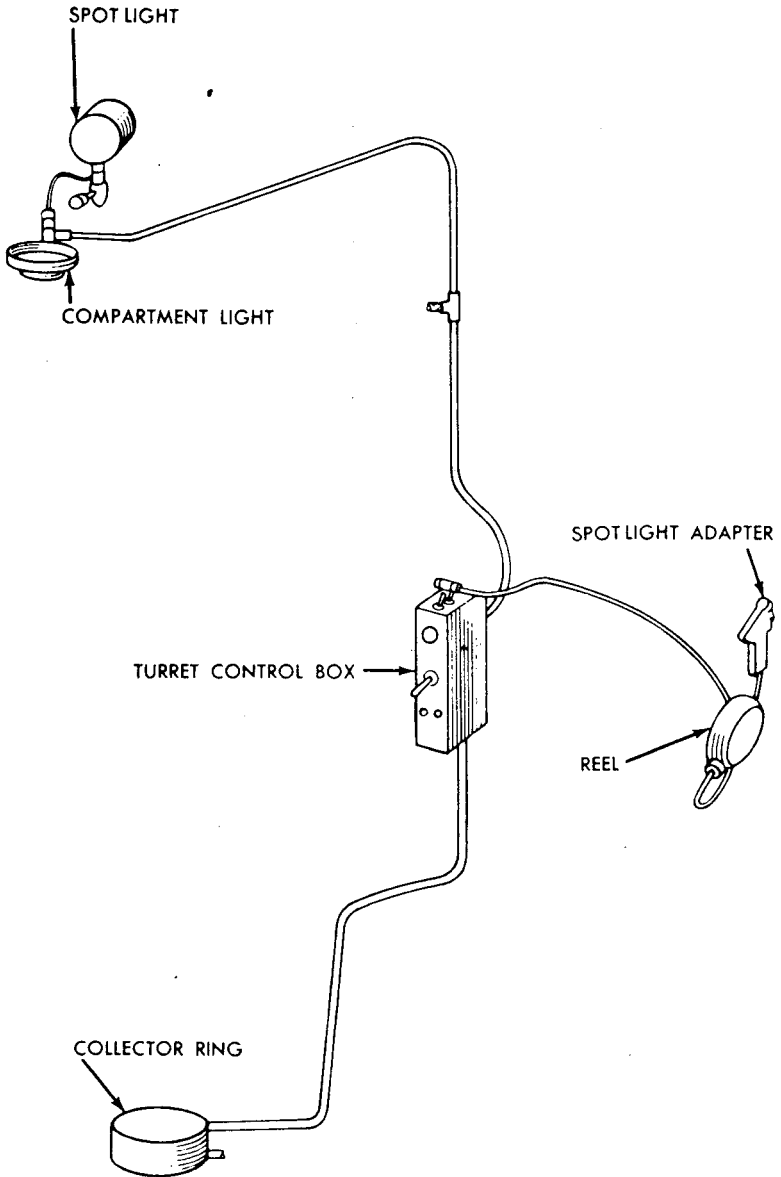

RA PD 329451

Figure 57—Turret Light Circuit (75-mm Dry Stowage Vehicles)

TROUBLE SHOOTING

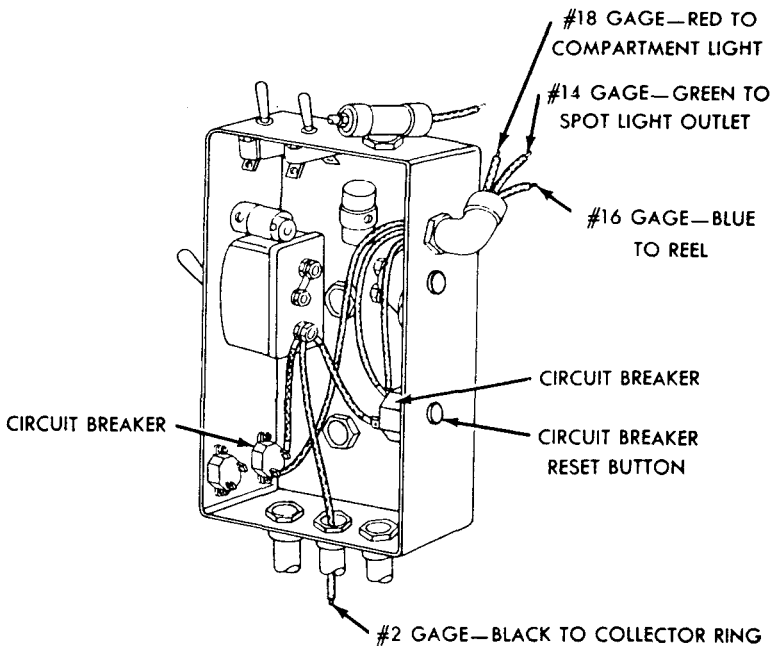

RA PD 329460

Figure 58—Terminal Box Connections for Turret Light Circuit (75-mm Dry Stowage Vehicles)

or grounded wire is in the circuit to the service headlights, or in the service taillight wires. Replace or repair the damaged wires. If the damage to the wires is caused by a damaged conduit, replace the damaged section of the conduit.

48. HORN OR SIREN.

a. Horn or Siren Will Not Sound.

(1) **PRELIMINARY STEPS.** Be sure the horn or siren circuit breaker reset button is pushed in. Turn the instrument panel light switch on. If the panel lights come on, it will indicate that current is being delivered to the instrument panel and to the horn or siren circuit breaker. Remove the horn or siren from its mounting bracket, and clean the base free from paint or corrosion to establish a good ground contact for the horn or siren. Reinstall the horn or siren. If the horn or siren fails to sound after establishing a good ground, proceed with the next test.

(2) **TEST HORN OR SIREN BUTTON.** Remove the cover from the horn or siren button box and contact a jumper wire across the con-

TANK, MEDIUM, M4A3

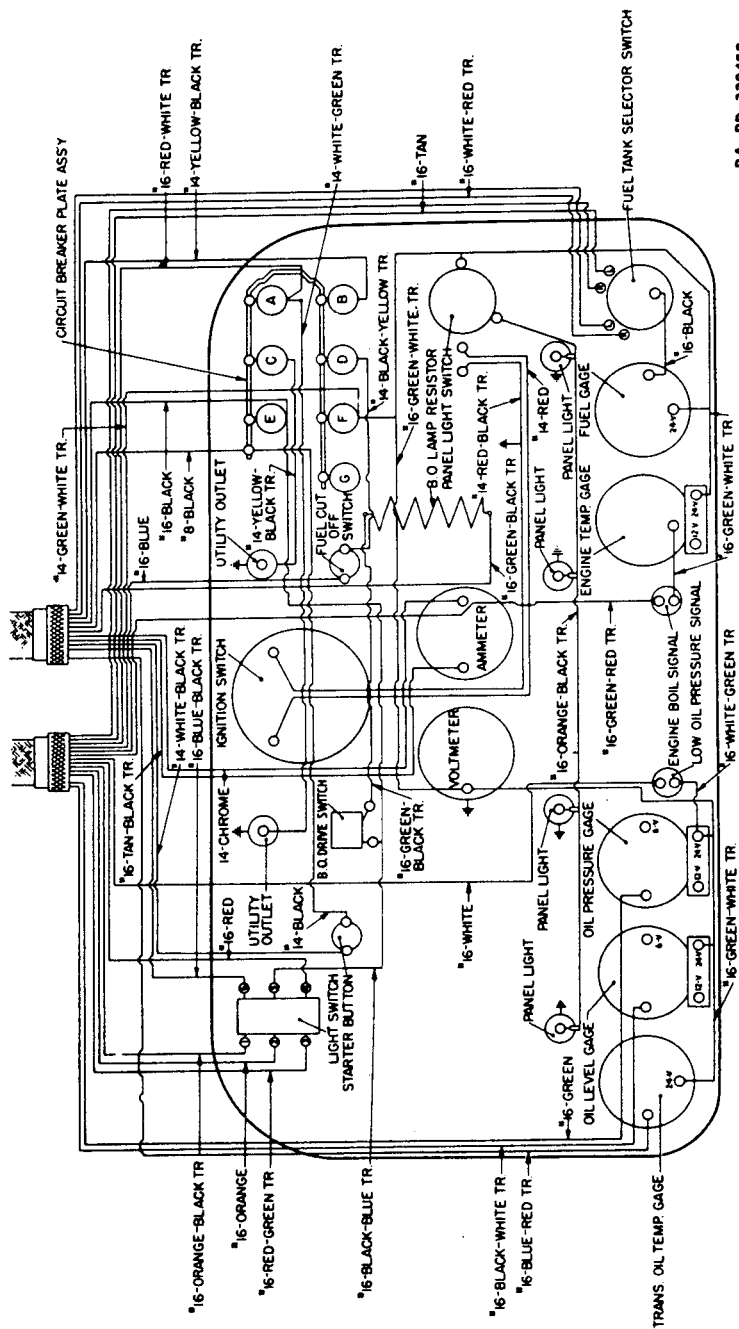

RA PD 329452

Figure 59—Instrument Panel Wiring Diagram (Medium Dry Storage Vehicles)

TROUBLE SHOOTING

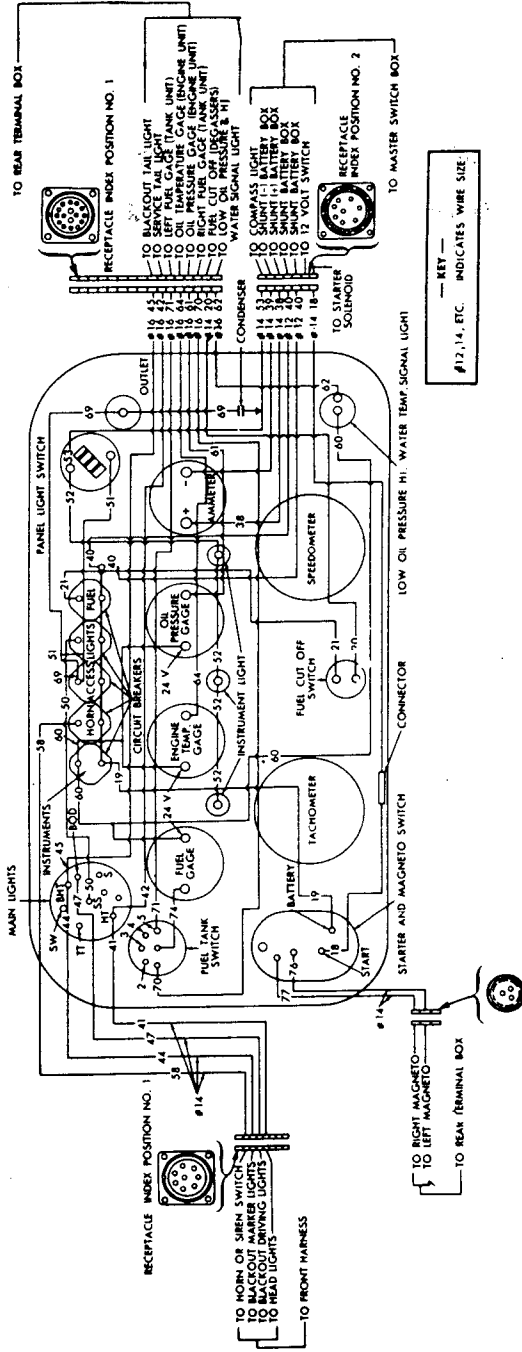

RA PD 329453

Figure 60—Instrument Panel Wiring Diagram (75-mm Wet Stowage, 76-mm, and 105-mm Howitzer Vehicles)

TM 9-759

48-51

TANK, MEDIUM, M4A3

tacts inside the box. If the horn or siren now sounds, the button assembly is at fault and must be replaced. If the horn or siren does not sound, replace the horn or siren.

49. CLUTCH.

a. Clutch Drag. If the gears clash when shifting into first or reverse gears, or if the vehicle has a tendency to roll when the clutch is disengaged, adjust the clutch (par. 110 e). If adjusting the clutch does not correct the trouble, replace the clutch disk or pressure plate, whichever is required (par. 110 h).

b. Pedal Pressure Too Stiff. If the pedal pressure is too stiff, lubricate the clutch linkage. If lubricating the clutch linkage does not correct the stiffness of the clutch pedal, if equipped with a clutch booster spring, adjust the spring (par. 110 g (2)). If the spring is broken, replace it (par. 110 g). If stiffness still prevails on vehicles with or without the booster, adjust the linkage (par. 110 f).

c. Clutch Slips. If the clutch slips, adjust the clutch as outlined in paragraph 110 d. If the clutch continues to slip after being adjusted, replace the clutch disk or pressure plate, whichever is required (par. 110 h).

d. Clutch Grabs. If the clutch grabs or chatters, replace the clutch disk or pressure plate, whichever is required (par. 110 h).

50. PROPELLER SHAFT.

a. Backlash. If the universal joint trunnion bearings are worn or damaged, notify higher authority. Tighten the universal joint flange bolts if they are loose.

b. Propeller Shaft Vibration. If the universal joints are worn or damaged, notify higher authority. Tighten the universal joint flange bolts if they are loose.

51. POWER TRAIN (TRANSMISSION, DIFFERENTIAL, AND FINAL DRIVE).

a. Lubricant Leakage. Tighten the filler plug and drain plugs. Check the flexible hose and cooler tube connections, and tighten if necessary. Notify higher authority if they are damaged. Check the final drive housing cover gasket and tighten the cap screws, replace the gasket if damaged. Check the brake and transmission inspection covers. Tighten the cap screws, or replace the gaskets if damaged. Check the input and output shaft oil seals or gaskets. Notify higher authority if these oil seals or gaskets are damaged.

TROUBLE SHOOTING

b. One Side of Track Will Not Move (Engine Running and Transmission in Gear). Check for broken final drive shaft on compensating shaft. If the final drive shaft is broken, replace the final drive unit. Check the final drive shaft gear or compensating gear for stripped teeth. If either gear has stripped teeth, replace the final drive unit. Check for broken final drive assembly parts. If any parts are damaged or broken, notify higher authority.

c. Hard Shifting (Severe Gear Clash). Hard shifting can be caused by incorrect clutch linkage adjustment (par. 110 f). Check for clutch drag (par. 110 e). Check the transmission gearshift lever for binds. Clean and lubricate gearshift lever. If the above correction does not correct hard shifting, the transmission has worn or damaged parts. Notify higher authority.

d. Backlash. Backlash is caused by worn or damaged final drive or transmission. Notify higher authority.

e. Poor Steering. Adjust the steering brakes (par. 116). Remove the brake inspection cover, and replace the brake lining if it is worn (par. 115).

52. HYDRAULIC TRAVERSING SYSTEM.

a. General. Before investigating troubles in vehicles equipped with hydraulic turret traversing mechanism, place the turret traversing shifter lever in the down position, and traverse the turret by hand to make sure the turret will rotate smoothly in both directions.

b. Turret Fails to Turn.

(1) **ELECTRIC MOTOR FAILS TO RUN.** Push the turret circuit breaker reset button. Replace or tighten any loose or broken wires. Test the battery. Recharge or replace the batteries if they are low in charge. If the motor is burned out, replace it. (A burned-out motor can be detected by smell or burned wires.)

(2) **PUMP INOPERATIVE BUT MOTOR RUNS.** If the motor shaft to pump coupling is broken, replace the coupling. If the coupling is not broken, the pump is at fault and must be replaced.

(3) **PUMP RUNS BUT TURRET DOES NOT OPERATE.** Move the traverse shift lever to the hydraulic traversing position. Release the turret lock. Fill the reservoir to the proper level. If the batteries are low, recharge or replace them. If the high-pressure relief valve is sticking, or has a broken spring, clean it or replace the spring. If the control handle is not turning the eccentric, tighten the control handle set screw. Remove the inspection plate. If the shaft is broken, replace it. Clean the turret ring gear and race, if required.

TANK, MEDIUM, M4A3

If the control cam pistons are sticking, remove the inspection plate and clean the assembly. If the pistons are still sticking, replace the pump. If the hydraulic motor shaft turns, replace the motor.

c. Turret Will Traverse in One Direction Only. Clean or replace the gear box, if required. If the back-up slide block piston is stuck, clean or replace the pump. Remove the two plugs and examine the check valves on the pump. Clean or replace the check valves.

d. Turret Creeps in One Direction. If the turret creeps in one direction, with the vehicle level, adjust the control eccentric shaft.

e. Turret Moves With Control Handle in Neutral. If the pilot valve plunger is stuck, clean or replace pump. Reset the position of the pump control eccentric shaft, if required. If the control cam pistons are stuck, free them up or replace the pump.

f. Turret Turns Excessively on a Slope.

(1) **PUMP SUCKING AIR.** Fill the reservoir to proper level. Tighten the gear pump suction tube connection if required. If the trouble is still not corrected, replace the pump.

(2) **HIGH-PRESSURE RELIEF VALVE STICKING.** If the return line is hot, clean or replace the high-pressure relief valve.

g. Unsteady or Sluggish Turret Operation. Fill the reservoir to proper level. Recharge or replace the batteries, if required. Traverse the turret manually to check the ring gear and pinion for binds. Clean any foreign matter in the turret ring gear. Reset the clearance between the ring gear and pinion, if required. Tighten any loose wire connections. Remove the relief valve caps. If the relief valves are sticking, clean or replace the valves. If the pinion shaft is broken or has a sheared key, replace the unit. Tighten all loose gear pump suction tube connections. If trouble is not corrected, replace the pump.

h. Slow Traverse in One Direction. If the back-up slide block piston and spring is stuck or broken, clean or replace the piston or spring. Clean and free-up the check valves if leaking. Readjust the eccentric control shaft adjustment, if necessary.

i. Oil Leaks From Pump to Motor. Replace worn shaft oil seals or damaged gaskets, if necessary. Tighten or replace loose tube connections, if necessary.

j. Abnormal Noise in Pump Motor or Adapter. Fill oil reservoir to proper level. If this does not correct the fault, the parts are excessively worn or damaged. Replace the units.

TROUBLE SHOOTING**TRACKS AND SUSPENSION.**

a. **Bogie Wheel Tire Wear.** Replace any bent, broken or missing track connectors. Replace dead track shoes (pars. 125 or 133). Remove any mud or stones from between the end connectors. Replace the bogie wheel arm if the gudgeon bushing is excessively worn.

b. **Volute Spring Breakage.** Replace worn gudgeons, if necessary. If three or more inner coils of both springs, in any suspension, rest upon the lower spring seat, the volute springs are weak. Replace the volute spring. When replacing volute springs in any suspension, replace both springs regardless of the condition of the other spring. Replace broken or cracked spring seats.

c. **Thrown Tracks.** Adjust track tension, if necessary (pars. 125 d or 133 d). Tighten the idler wheel bracket bolts, if necessary. Clean out rocks which might have wedged between the idler and track. If the idler shaft is loose on the bracket, lock the idler adjustment.

d. **Inoperative Track Support Rollers.** Clean any mud from between the support roller and track. Raise the track off the support roller, and rotate the roller. If the roller does not turn, replace it (pars. 127, 128, or 135). Lubricate the rollers, if necessary.

e. **Inoperative Idler Wheel.** Disconnect the track at the idler wheel (par. 125 b), and rotate the idler wheel. If the idler wheel does not turn freely, lubricate, or replace it (pars. 126 or 134).

54. RADIO SUPPRESSION SYSTEM.

a. **Preliminary Instructions.** When radio interference is experienced, the vehicle should be moved to an open space away from high-tension power lines, machinery which causes electrical disturbances, buildings, and other radio-equipped vehicles, before attempting to make tests for determining the cause for interference.

b. **Radio Reception Satisfactory When Vehicle Is Not in Motion, and Becomes Noisy When Engine Is Started.**

(1) **TEST GENERATING SYSTEM FOR INTERFERENCE.** Remove the generator field wire (figs. 117 and 118) and run the engine. On vehicles equipped with two generators, remove the field wire from both generators. If radio interference has been reduced or eliminated, it indicates that the generating system is causing interference. Replace the generator regulator (par. 104 b), and run the engine at a speed of approximately 1,000 revolutions per minute, after the replacement. If the generator regulator is not at fault, replace the condensers in the radio terminal box (fig. 185) and run the engine. If the condensers in the generating system are not at fault, test all

TM 9-759

54-55

TANK, MEDIUM, M4A3

units and conduits in the generating system for a good ground. To make this test, use a jumper wire with handles containing prods which will penetrate through painted surfaces. Run the engine at a speed where the interference is at its maximum, and contact the jumper wire between a good ground and the generator housing, generator regulator housing, or terminal boxes, and conduits in the generating circuit. If interference has been improved or eliminated by any of these tests, see if bonding straps are in good condition, and have a good ground contact on the units on which bonding straps are used. Replace the internal-external toothed washers on units grounded by this type of washer (par. 152 b (4)).

c. Radio Interference When Vehicle Is Not in Motion and Engine Is Not Running. The most probable cause for interference under this condition is that units or component parts of the hull do not have a good ground contact with the main part of the hull. To test, use a long jumper wire with a handle containing a prod which will penetrate painted surfaces. Attach the other end of the jumper wire to the ground terminal of the battery, and contact the prod on all units of the vehicle, all conduits and terminal boxes, and each component part of the hull, also fenders and dust shields. If improvement is obtained in the radio reception by making contact with the jumper wire at any of these points, the unit or part must be grounded to the part to which it is attached. These parts are grounded by means of bonding straps and/or internal-external washers. (See paragraph 152 b (4) for bonding strap installation and for internal-external toothed washer installation.)

d. Radio Interference When Vehicle Is in Motion, and No Interference Under Other Conditions. The most probable cause for interference will be poor ground contact in some unit or component part of the vehicle due to vibration in the vehicle under operating conditions. Make test, as outlined in subparagraph c above, while the vehicle is in motion.

Section XIV

ENGINE DESCRIPTION, DATA AND MAINTENANCE IN VEHICLE

55. DESCRIPTION AND DATA.

a. Description (figs. 61 through 65). This vehicle is powered with a 60-degree V, 8-cylinder, 4-cycle, valve-in-head, liquid-cooled Ford tank engine. The cylinder block and crankcase are cast integral of aluminum, with steel dry-type sleeves in cylinder bores. The

ENGINE DESCRIPTION, DATA AND MAINTENANCE IN VEHICLE

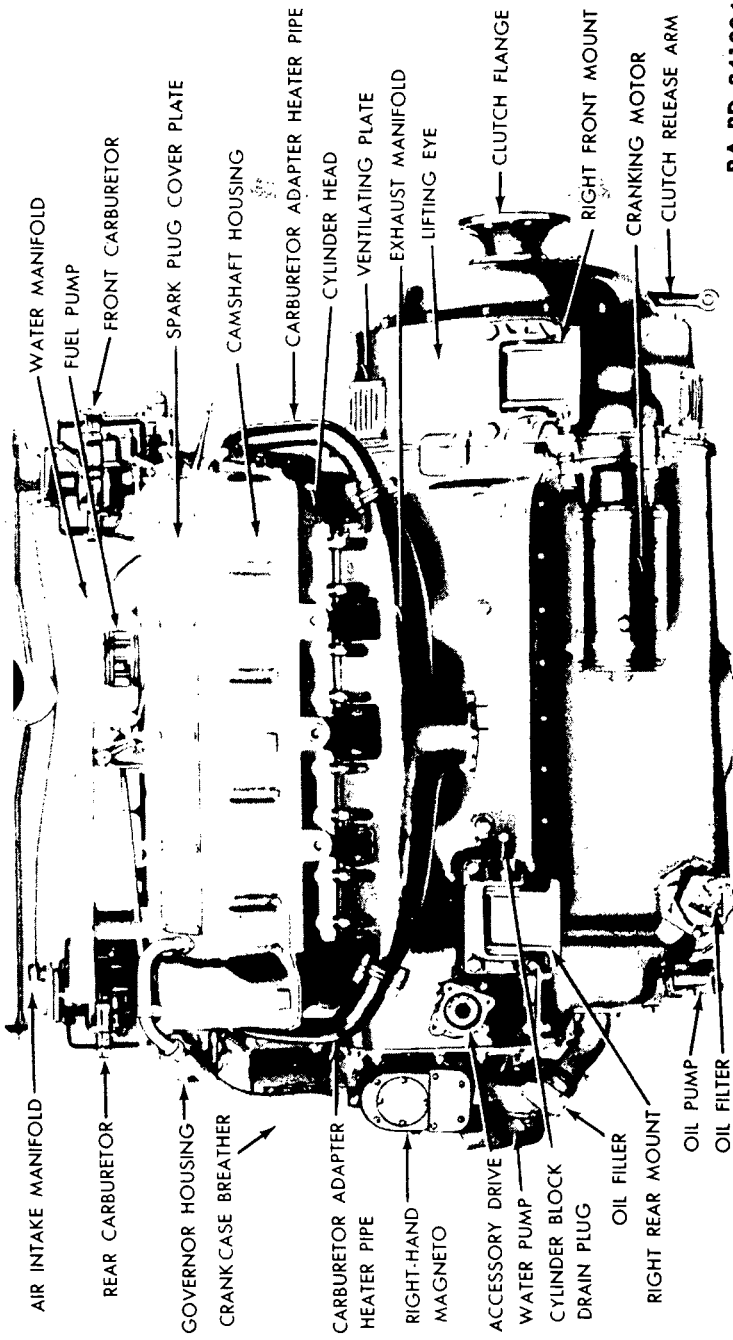

RA PD 341204

Figure 61—Engine—Right Side (Early Engines)

TANK, MEDIUM, M4A3

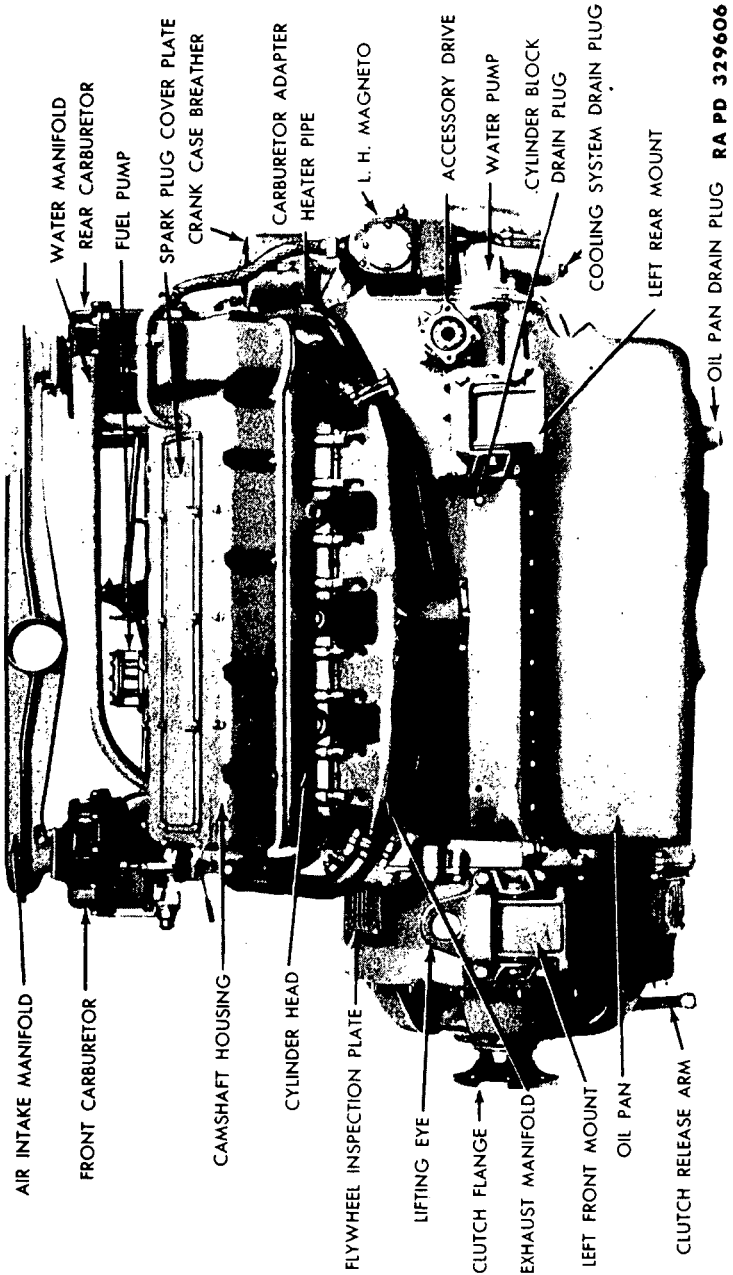

Figure 62—Engine—Left Side (Engines)

ENGINE DESCRIPTION, DATA AND MAINTENANCE IN VEHICLE

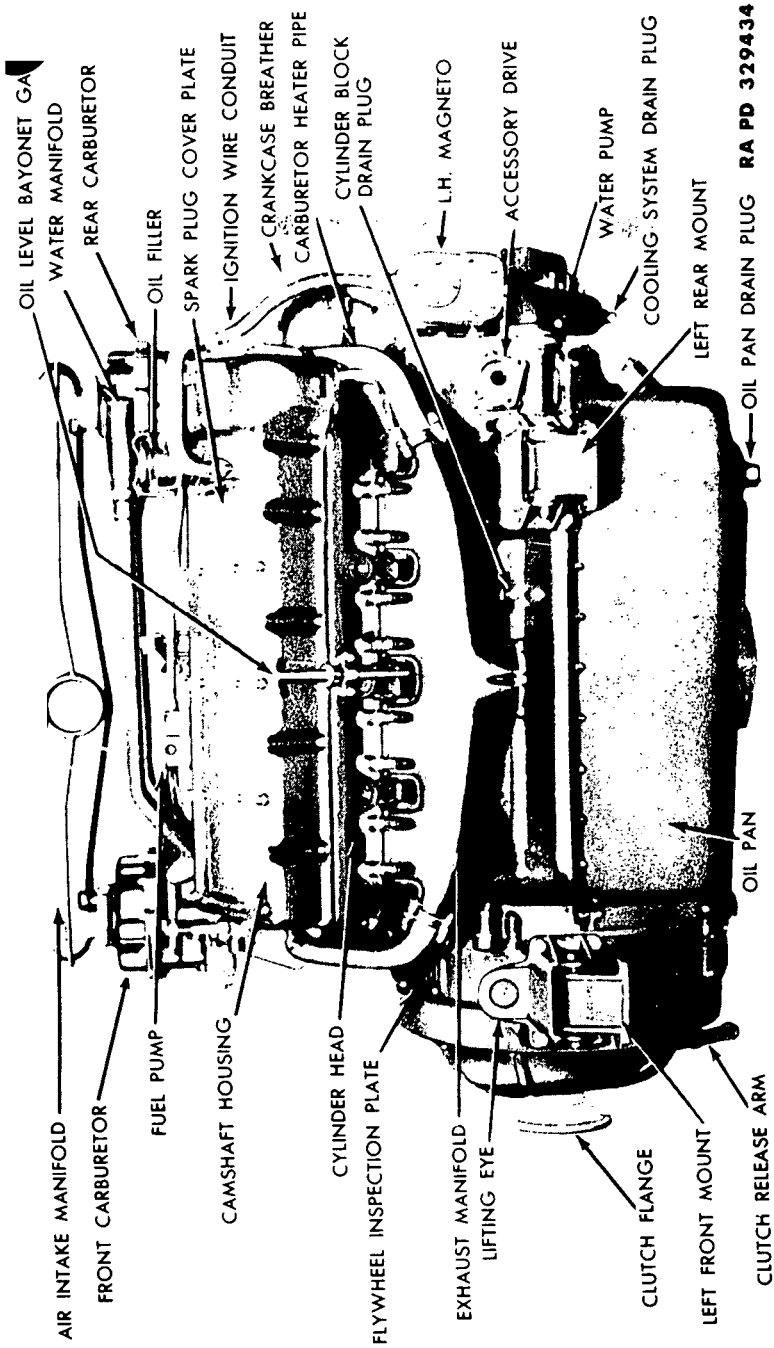
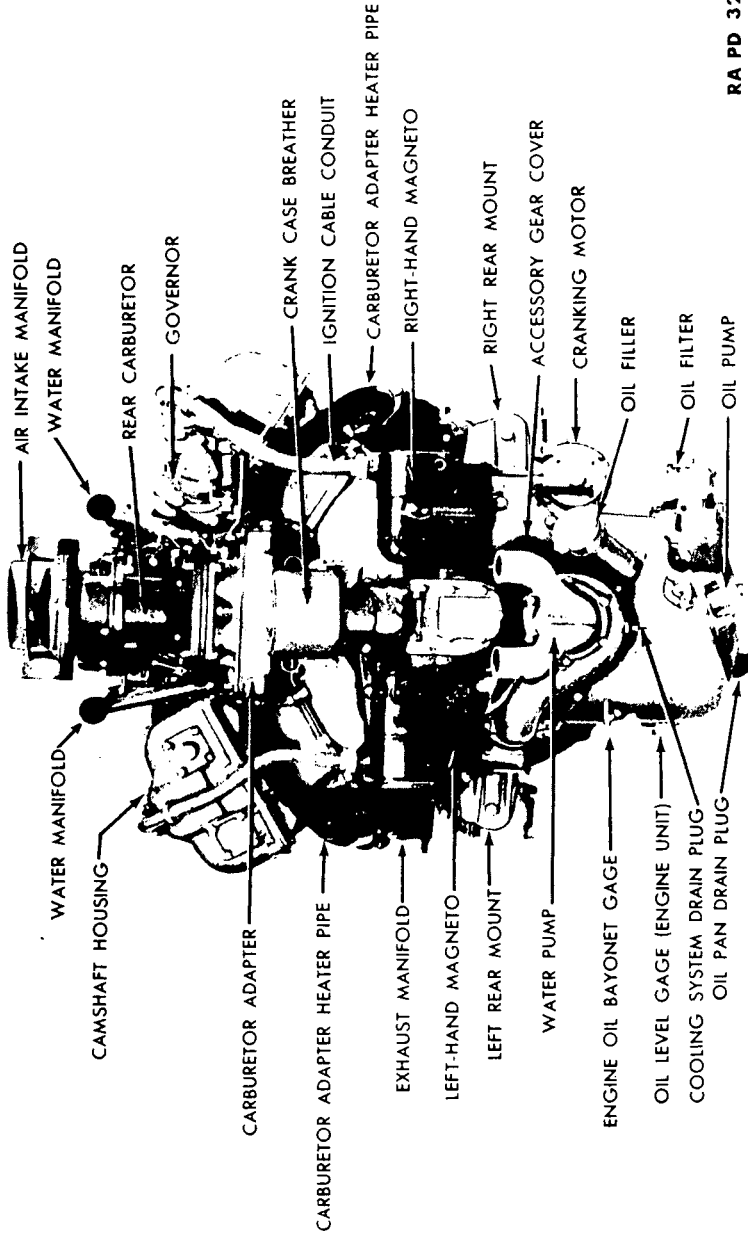

Figure 63—Engine—Left Side (Later Engines)

TANK, MEDIUM, M4A3



RA PD 329511

Figure 64—Engine—Rear

ENGINE DESCRIPTION, DATA AND MAINTENANCE IN VEHICLE

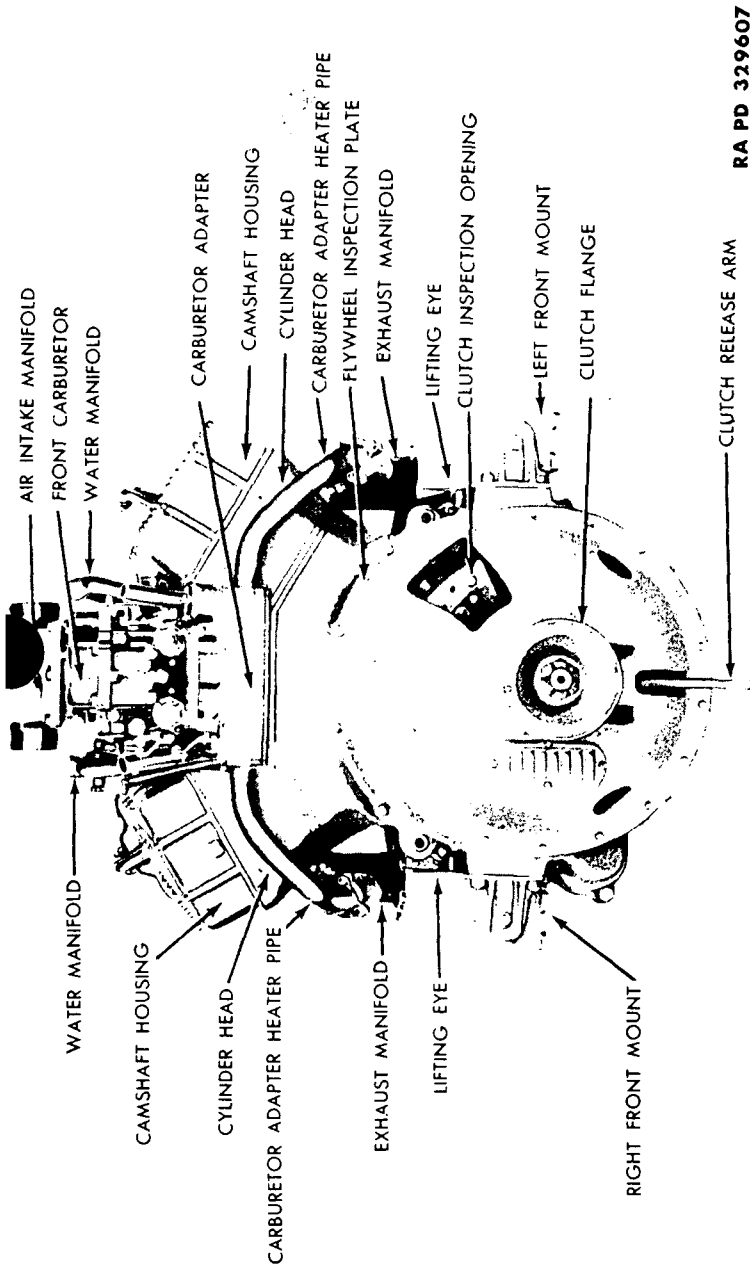

Figure 65—Engine—Front View

TANK, MEDIUM, M4A3

water jackets extend the full length of the cylinders. Four overhead camshafts are used, one exhaust and one intake, for each bank of cylinders. There are two exhaust and two intake valves in each cylinder. Two 4-cylinder magnetos are used. These are located at the rear of the engine, one mounted at each end of a cross shaft driven by gears. The water pump (fig. 64) is driven from the end of the crankshaft. Two accessory drive housings, located on the side walls of the engine compartment, are each driven through an accessory drive shaft and universal joints by the accessory drive gears in the engine. Two pusher-type fans are driven through double V-type belts by the accessory drives.

b. Location and Mountings. The engine is mounted at the rear of the vehicle, and is supported by four brackets. The two front brackets are mounted on the engine compartment bulkhead. The two rear brackets are mounted on the engine compartment floor. Rubber mounts are used between the brackets and the engine.

c. Definition of Terms. The flywheel end of the engine will be referred to as the "front" of the engine, as the engine is mounted in the vehicle with the flywheel forward. The terms "right" and "left" are used with reference to the engine as viewed from the rear looking toward the front of the vehicle.

d. Tabulated Data. The following data include the general information and engine characteristics which are frequently required for reference:

General:

Make and type	Ford V-type, 8-cylinder, liquid-cooled, tank engine
Model	GAA
Over-all dimensions (including clutch):	
Length	59.02 in.
Width	33.25 in.
Height	47.78 in.
Weight (without accessories)	1,470 lb
Weight (with accessories)	2,350 lb
Net horsepower at 2,600 rpm	500
Net torque at 2,100 rpm	950 ft. lb
Number of cylinders	8
Bore	5.4 in.
Stroke	6 in.
Piston displacement	1,100 cu in.
Compression ratio	7.5 to 1

ENGINE DESCRIPTION, DATA AND MAINTENANCE IN VEHICLE

Direction of rotation (viewed from rear of engine):
 Crankshaft Clockwise
 Cranking motor Counterclockwise
 Magnetos:
 Right-hand rotor Clockwise
 Left-hand rotor Counterclockwise
 Accessory speeds:
 Fan 1.4 crankshaft speed
 Magneto rotors ½ crankshaft speed
 Magnetos:
 Make Bosch
 Model:
 Right-hand MJF4A-308, MJF4B-314, or MJF4B-316
 Left-hand MJF4A-307, MJF4B-311, or MJF4B-315
 Breaker point gap 0.014 in. to 0.016 in.
 Spark plug gap:
 New 0.011 in. to 0.014 in.
 Service maximum limit 0.030 in.
 Valve clearance (nonadjustable) 0.025 in. to 0.030 in.
 Carburetor—make and model
 (2 used) Bendix-Stromberg NA-Y5G
 Numbering of cylinders from rear to front:
 Right bank 1-2-3-4
 Left bank 1-2-3-4
 Firing order: 1-R, 2-L, 3-R, 1-L, 4-R, 3-L, 2-R, 4-L

56. INTAKE AND EXHAUST MANIFOLDS.

a. **Intake.** The intake manifolds are cast integral with the cylinder heads, and are open at each end. Carburetor adapters are installed between the carburetors and the intake manifolds. These adapters are likewise connected to the exhaust manifolds which permit the exhaust gases to heat the fuel air mixture as it comes from the carburetors. These adapters each contain two butterfly valves operated by the engine speed governor.

b. Exhaust.

(1) **DESCRIPTION** (figs. 61 and 62). Two exhaust manifolds are used, one attached to each cylinder head. The end of each manifold is attached to the carburetor adapter housing by means of a connecting pipe.

TM 9-759

56-57

TANK, MEDIUM, M4A3

(2) **REMOVAL.** Open the engine compartment doors. Remove the lock wire and the three cap screws from the upper flange. Remove the lock wire and the three bolts from the lower flange of the heater pipes which connect the ends of the exhaust manifold to the carburetor adapter housings. Remove the six bolts at the center flange of the exhaust pipe. Remove the lock wire and 16 brass nuts securing the manifold to the cylinder head, and remove the manifold. The above procedure applies to either the right or left manifold.

(3) **INSTALLATION.** Place new gaskets (B258270) and the manifold in position, and secure the manifold to the cylinder head with 16 brass nuts. Replace the six bolts at the center flange of the exhaust pipe. Install new gaskets at both ends of the heater pipe, and fasten the ends to the manifold with three bolts. Fasten each of the heater pipes to the carburetor adapter housings with three cap screws. Close and fasten the engine compartment doors.

57. ENGINE MOUNTS.

a. **Description** (fig. 66)). The four engine mounts, used to support the engine, provide flexible rubber installation between the engine and its mounting brackets.

b. **Front Engine Mount Removal** (right or left side). Remove the engine compartment floor plate (par. 63 d). Place a jack under the front of the engine oil pan, using a wood block between the oil pan and jack. Raise the engine high enough to take the weight off the engine front mounts. Remove the four bolts which hold the mount to the support bracket. Two of these bolts are accessible through the inspection opening in the bulkhead, and two through the engine floor plate opening. Remove the long bolt which holds the halves of the mount together (fig. 66). Remove the four nuts which hold the upper bracket portion of the mount to the clutch housing. The two rear nuts are accessible through the engine floor plate opening, and the two front nuts through the inspection opening in the bulkhead.

c. **Engine Front Mount Installation.** Position the upper bracket portion of the mount on the clutch housing, and secure it with four nuts. Fasten the mount to the support bracket with four bolts, remove the jack and install the engine compartment floor plate.

d. **Engine Rear Mount Removal** (right or left side). Follow the steps in subparagraph b above, except place the jack under the rear of the engine oil pan. Remove the four bolts which hold the mount to the support bracket. Remove the four nuts which hold the mount to the engine, and remove the mount.

ENGINE DESCRIPTION, DATA AND MAINTENANCE IN VEHICLE

RA PD 28133

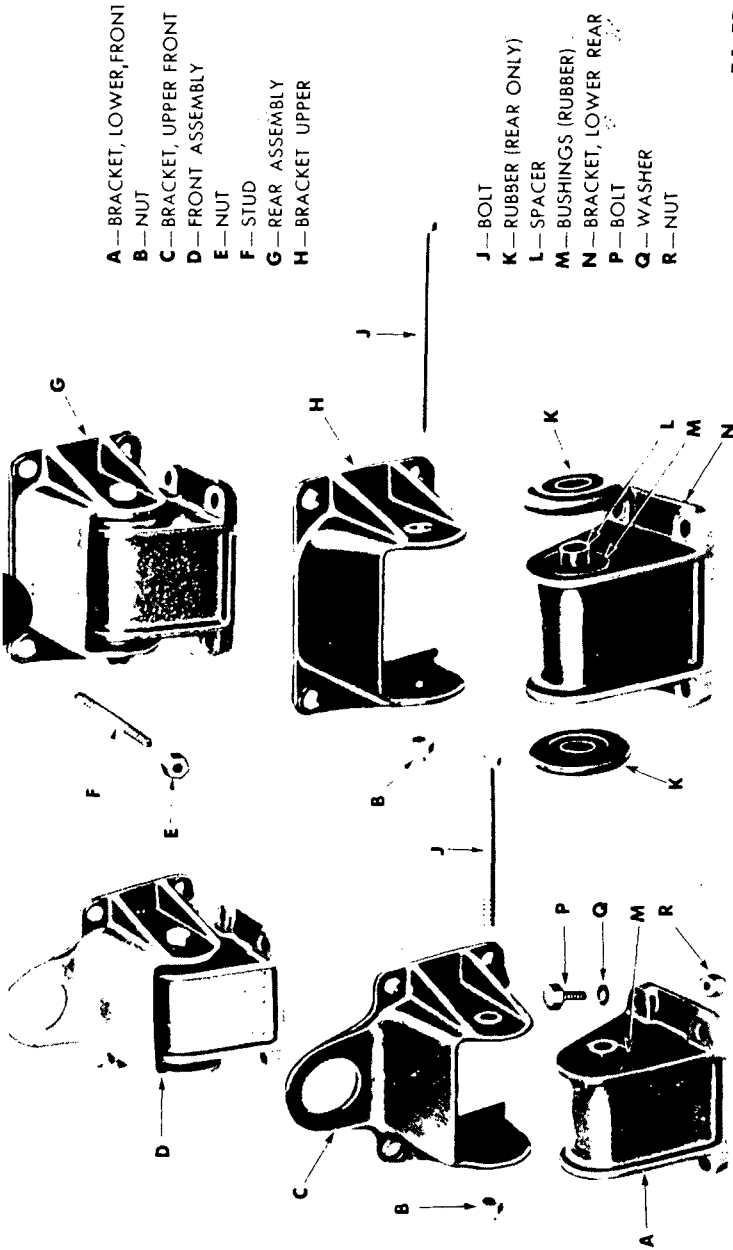

Figure 66—Engine Mounts Assembled and Disassembled

TM 9-759

57-58

TANK, MEDIUM, M4A3

e. **Engine Rear Mount Installation.** Secure the mount to the engine with four nuts, and to the support bracket with four bolts. Remove the jack, and install the floor plate (par. 64 b).

58. CYLINDER HEAD GASKETS.

a. Removal.

(1) **PRELIMINARY STEPS.** Remove the engine compartment floor plate (par. 63 d). Open the engine compartment rear door (par. 63 c). Place a large pan under the engine compartment floor plate opening. Remove the lock wire and drain plug from the bottom of the water pump (fig. 64) and allow the water to drain. Remove the cap screws that hold the engine compartment doors closed, and open the doors. Remove the cap screws that hold the engine compartment front cover plate to the hull, and remove the plate.

(2) **REMOVE AIR CLEANERS.** Air cleaners on vehicles having the air cleaners in the engine compartment are to be removed (par. 76 b).

(3) **REMOVE WATER MANIFOLDS** (figs. 61 and 62). Loosen the hose clamps on the hose that connect the water manifold and radiator, and remove the hose. Loosen the clamps on the hose that connect the water manifold and the expansion tank, and remove the hose. Remove the four nuts and flat washers that hold each water manifold to the cylinder head, and remove the manifolds.

(4) **REMOVE JUNCTION BOX** (fig. 77). If a junction box is mounted on the left-hand cylinder head, it must be removed. To remove the junction box, unscrew the collar on each of the plug connectors and pull the two plugs out of the junction box. Remove the two screws that hold the conduit bracket to the upper part of the junction box. Remove the four nuts that hold the junction box to the camshaft housing, and lay the box to one side where it will not interfere when removing the camshaft housing or cylinder head.

(5) **REMOVE FUEL PUMP AND DISCONNECT FUEL LINES.** Close all of the fuel shut-off valves. Disconnect the three fuel lines at the fuel pump. Remove the two nuts and flat washers that secure the pump to the camshaft housing. Slide the fuel pump off the studs. Disconnect the primer line at the connection.

(6) **REMOVE THROTTLE AND GOVERNOR CONTROLS.** Disconnect the throttle rod at each carburetor. Disconnect the throttle rod at the lever control bracket mounted on the engine compartment bulkhead. Remove the two nuts and flat washers that hold the throttle rod bracket assembly to the cylinder head, and remove the assembly. Disconnect the governor control rod at each carburetor adapter, and remove the rod.

ENGINE DESCRIPTION, DATA AND MAINTENANCE IN VEHICLE

(7) **REMOVE EXPANSION TANK** (fig. 77). Disconnect the two overflow lines at the expansion tank. Remove the four cap screws that secure the expansion tank to the bulkhead, and remove the tank.

(8) **REMOVE CARBURETORS** (fig. 63). Disconnect the degasser electrical connections at each carburetor. Remove the four nuts that secure each carburetor to the adapter housings. Lift the air intake manifold and carburetors as an assembly from the engine.

(9) **REMOVE GOVERNOR** (fig. 64). Remove the cotter pin from the ball joint connection on the governor arm, unscrew the ball seat plug from the ball connection on the governor arm, and disconnect the connecting link. Remove the six nuts which hold the governor to the camshaft housing and remove the governor.

(10) **REMOVE TACHOMETER DRIVE UNIT** (fig. 64). If the tachometer drive assembly is mounted in the camshaft housing, it must be removed. To remove the tachometer drive unit, remove the four nuts from the mounting flange and pull the assembly and driving quill from the camshaft housing.

(11) **REMOVE SPARK PLUGS, WIRES AND CONDUIT ASSEMBLY.** Remove the 10 nuts from each cover over the spark plugs, and remove the covers. With special wrench (41-W-3336-300), unscrew the spark plug terminal nuts from the spark plugs (fig. 88). Remove the four nuts holding each conduit to the camshaft housing and remove the wire and conduit from the housing. Remove the spark plugs with special wrench (41-W-3336-300) (fig. 88).

(12) **REMOVE CAMSHAFT HOUSINGS.** Remove all nuts from the top and lower edge of each camshaft housing and remove the housings from the cylinder heads. **CAUTION:** *Lift the housings evenly so that the long studs will not be bent.*

(13) **CHECK PUSH ROD CLEARANCE.** Before removing the camshafts, check the push rod clearance. The proper clearance is 0.025 inch to 0.030 inch, taken between the top of the push rod and the heel of the cam. Use a feeler gage for checking the clearance. Make a record of the clearances. If any are found that are not within the recommended limits, notify higher authority.

(14) **REMOVE CAMSHAFTS.** Remove the two nuts from each bearing cap and remove the caps from the camshaft bearings. Remove the four nuts holding the camshaft support to the cylinder head. **NOTE:** *Nuts from the bearing caps and the supports must be loosened evenly to prevent undue strain on the camshafts due to the valve spring pressure.* Remove the snap ring at the top of the camshaft drive worm gear on each block, and lift the upper drive shaft from the gear (fig. 67). Lift the camshaft from the cylinder heads. The intake and exhaust camshafts and the rear support are

TANK, MEDIUM, M4A3

RA PD 27553

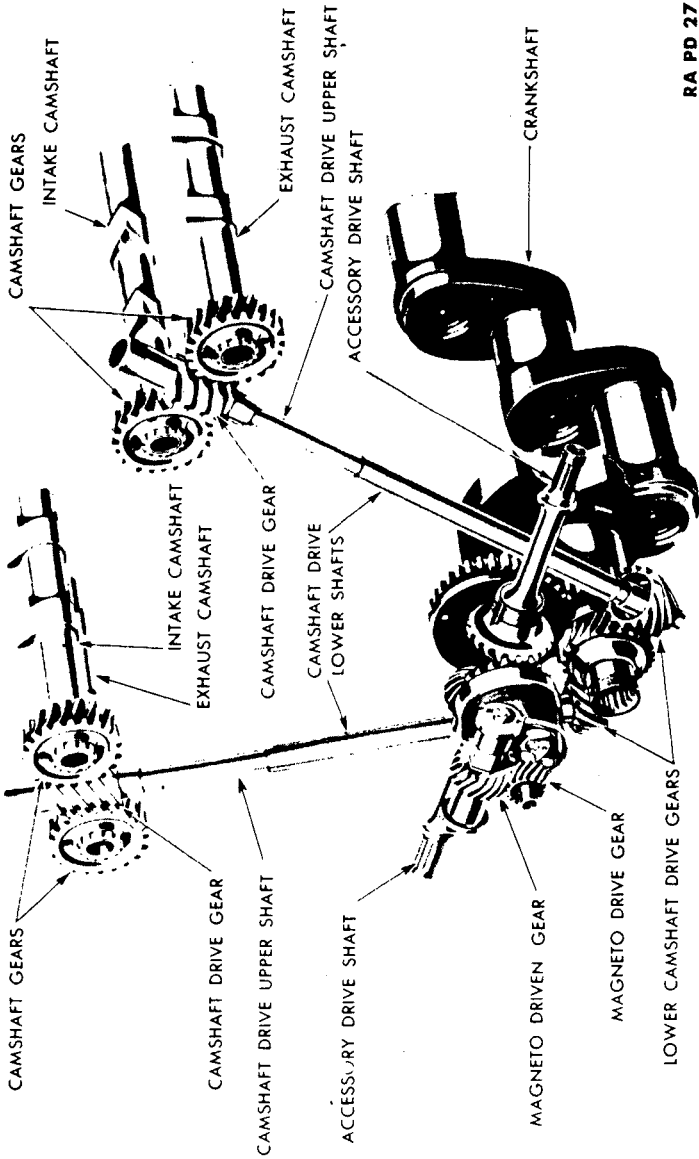

Figure 67—Accessory Gear Assembly

ENGINE DESCRIPTION, DATA AND MAINTENANCE IN VEHICLE

be removed as an assembly (fig. 70). Lift the camshaft bearings from the studs.

(15) **SECURE PUSH RODS.** Secure the push rods in the guides with tape, or wire so as not to disturb them when removing the cylinder head, as they must be kept with the push rod guide to which they were originally fitted.

(16) **REMOVE CARBURETOR HEATER PIPES AND ADAPTER HOUSINGS** (fig. 64). Remove the lock wire and three cap screws from the upper flange and the lock wire and the three nuts from the lower flange of each pipe and remove the four heater pipes which connect the exhaust pipe to the carburetor adapter. Remove the six nuts securing each of the adapters to the cylinder heads and remove the adapter housings. A special offset wrench (41-W-639-850) is provided for removing the nuts on each side which are located behind the heater pipe flanges.

(17) **REMOVE CYLINDER HEADS.** Remove the 18 nuts securing each cylinder head to the cylinder block. Use special wrench (41-W-866-200) for removing the long cylinder head nuts. The long nuts are the eight nuts on each head which have the camshaft bearing studs screwed into them. Use special wrench (41-W-866-250) for the balance of the cylinder head nuts (short nuts). Lift the heads from the cylinder block and remove the head gaskets.

(18) **CLEAN CARBON.** Clean the carbon from the heads and each cylinder block.

b. Installation.

(1) **INSTALL CYLINDER HEAD GASKETS** (fig. 68). Place a new metal gasket (G104-15-93841) on the top of each cylinder sleeve, then install the cylinder head gasket (D-66347 left, or D-66346 right) in place on the cylinder block. *NOTE: Early production engines use an individual rubber seal at each water and oil tube instead of a conventional-type cylinder head gasket.* When cylinder heads are removed for any reason, the conventional cylinder head gasket must be installed, and all the rubber seals on the water and oil tubes must be omitted. The two large rubber seals at the extreme rear end of the cylinder block (fig. 68) on these early engines are to be used with this late type gasket.

(2) **INSTALL CYLINDER HEADS.** With a man at each end of the head, place the head over the studs and lower it evenly on the cylinder block. Care must be used when putting the head over the studs so as not to mar or damage the bottom face of the head.

(3) **TIGHTEN CYLINDER HEADS.** Place a washer and nut on each cylinder head stud. Eight long nuts (G104-17-14643) are used on the two center rows of studs, and 10 short nuts (G104-17-

TANK, MEDIUM, M4A3

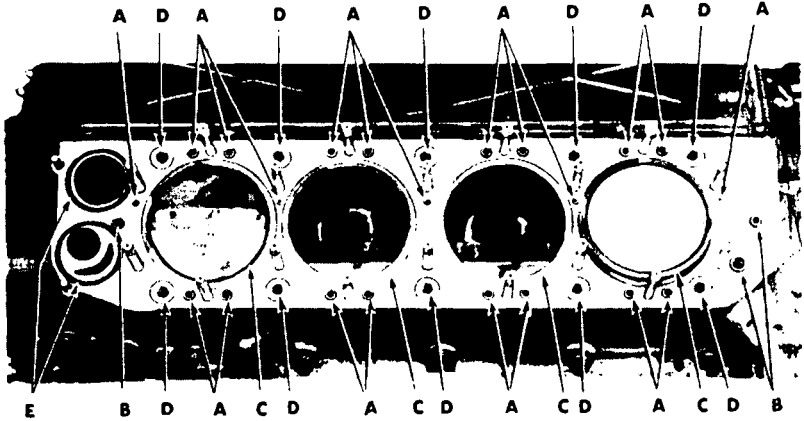

- A—WATER TUBES C—METAL CYLINDER GASKETS E—RUBBER SEALS
- B—OIL TUBES D—CORE PLUGS

SUB A—TOP OF CYLINDER HEAD

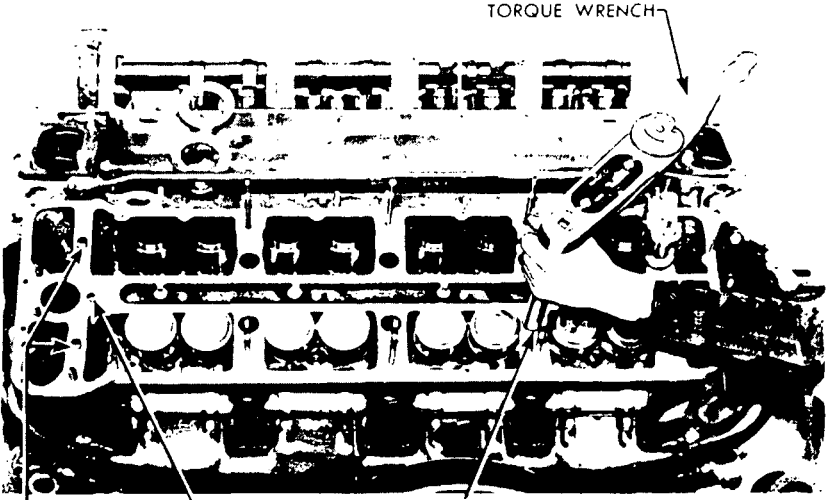

- DOWELS OIL TUBE CYLINDER HEAD NUT WRENCH

SUB B—TIGHTENING CYLINDER HEAD NUTS WITH TORQUE WRENCH (41-W-3630)

RA PD 341206

Figure 68—Cylinder Head Installation

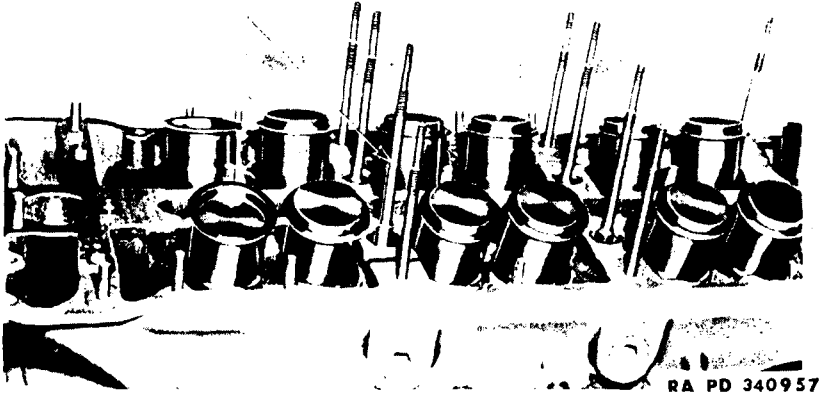
ENGINE DESCRIPTION, DATA AND MAINTENANCE IN VEHICLECAMSHAFT BEARING
STUD**Figure 69—Camshaft Bearing Studs**

14642) are used on the outer rows of studs. The center row of nuts over which the camshaft bearings set are longer than the balance of the nuts so as to accommodate the studs for the camshaft bearings. On all early production engines, do not install these long nuts without first removing the camshaft bearing studs from the nuts. Starting with engine number 9783, these cylinder head nuts are swedged on the threads of the camshaft bearing studs, and are not to be removed from the studs. Use cylinder head nut wrench (41-W-866-200) to tighten the long nuts, and use wrench 41-W-866-250) for tightening the short nuts. These wrenches are to be used in connection with torque wrench (41-W-3630). Tighten each nut to 60 foot-pounds tension, starting with a centrally located nut and working alternately each way (fig. 68).

(4) **INSTALL CAMSHAFT BEARING STUDS.** Install a stud in each of the eight long cylinder head nuts. This operation is not required on later engines having the cylinder head nut swedged on the threads of the stud as described in step (3) above.

(5) **RELEASE PUSH RODS.** Remove the holding tape or wire from the push rods.

(6) **INSTALL CAMSHAFT BEARINGS.** The camshaft bearings and bearing caps are numbered from 1 to 8 for each cylinder head. A corresponding number is stamped on the cylinder head at each bearing location. Place the eight bearings in position on the cylinder head to correspond with the number stamped on the cylinder head. Make certain that the bearings set firmly on the cylinder head.

TANK, MEDIUM, M4A3

CAMSHAFT AND GEAR ASSEMBLY

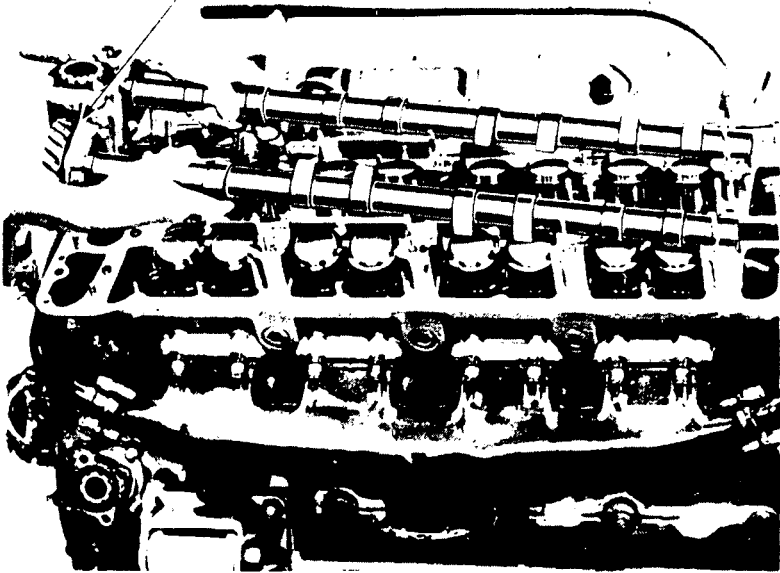

A—INSTALLING CAMSHAFT AND GEAR ASSEMBLIES

TURNING TOOL

DIRECTION OF ROTATION

INTAKE CAMSHAFT

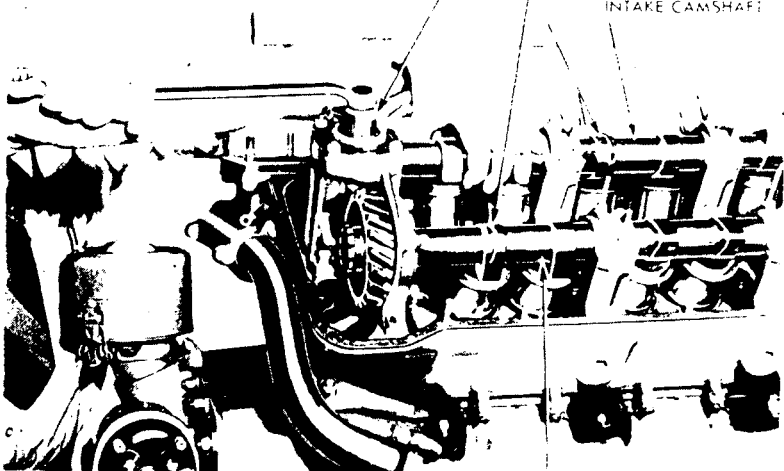

EXHAUST CAMSHAFT

B—SETTING CAMSHAFT TIMING WITH CAMSHAFT WRENCH
(41-W-2964-300)

RA PD 341205

Figure 70—Camshaft Gear Installation

ENGINE DESCRIPTION, DATA AND MAINTENANCE IN VEHICLE**(7) INSTALL CAMSHAFTS AND GEAR ASSEMBLIES (fig. 70).**

NOTE: The camshaft and gear assemblies consist of the intake and exhaust camshafts, the camshaft gears, and the rear support. The assemblies are right- and left-hand, and can be identified by the markings etched on the camshafts. Place each assembly in the camshaft bearings, and the rear support over the studs. Put each camshaft bearing cap on the bearing carrying a corresponding number, making sure the number on the cap is on the same side as the number on the bearing. Put a flat washer and self-locking nut (boot nut) on each stud and tighten all nuts evenly so as not to spring the camshafts as a result of the valve spring pressure. Use a torque wrench, and tighten the nuts to 16 foot-pounds.

(8) TIME CAMSHAFTS.

(a) Time Right-hand Camshaft (fig. 72). Remove the flywheel inspection plate on the top left side of the flywheel housing. Remove the circular plate from the right-hand magneto (fig. 83). Turn the engine in direction of rotation until the arrow in the window of the distributor plate of the right-hand magneto is pointing to the terminal to which the No. 1 spark plug wire (red wire) is attached, then continue to turn one complete engine revolution until the flywheel mark "INTAKE OPEN R.H." is at the pointer on the flywheel housing. Insert the camshaft turning wrench (41-W-2964-300) in the top of the worm gear and turn the camshafts in direction of rotation (the arrows in figure 70 show the direction of rotation) until No. 1 intake valve is just starting to open. The direction of rotation of the right- and left-hand intake camshafts is the same as the direction of rotation of the camshaft. The valve opening point can be determined by placing the thumb and forefinger on No. 1 intake valve push rod. Turn the camshaft slowly (fig. 70) and at the same time rotate No. 1 push rod. When the turning of the push rod becomes difficult, it is an indication that the valve has just started to open. With the flywheel still setting at the mark "INTAKE OPEN R.H.," insert the upper camshaft drive shaft (fig. 71). When inserting the upper camshaft drive shaft, it may be necessary to try it in several positions until the splines on each end of the shaft line up, at which time it will drop in place freely.

(b) Recheck Timing. Turn the flywheel backward approximately 30 degrees, then turn it in the direction of rotation until the timing mark "INTAKE OPEN R.H." (fig. 72) again appears at the pointer. No. 1 intake valve should have just started to open. If not, repeat the procedure outlined in step (1) above more carefully.

(c) Time Left-hand Camshafts. Turn the flywheel 300 degrees (five-sixths of a turn) in the direction of rotation until the mark "INTAKE OPEN L.H." on the flywheel appears at the pointer. From

TANK, MEDIUM, M4A3

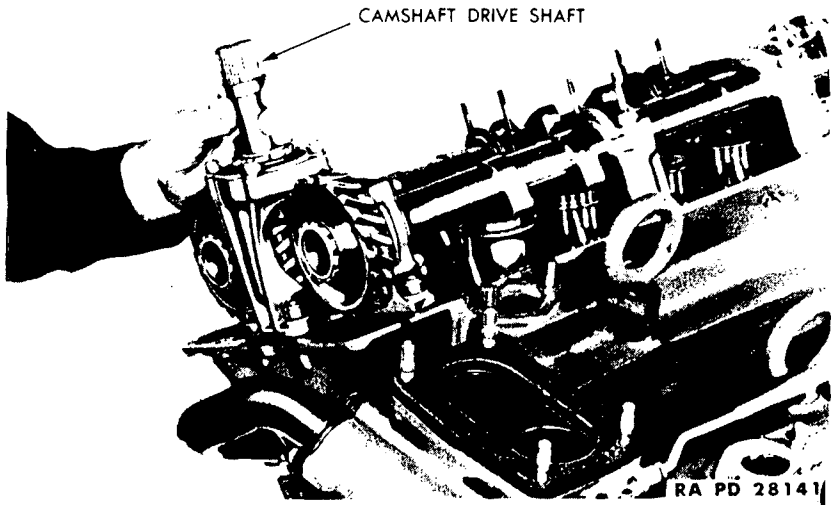

Figure 71—Inserting Camshaft Drive Shaft (Upper)

this point, the procedure for timing the left-hand camshaft is the same as described for the right-hand camshafts. The opening of the No. 1 intake valve is used when establishing the timing of the camshafts on the left side also.

(d) *Install Snap Ring.* Install a snap ring in the top of each camshaft worm gear to hold the upper camshaft drive shaft in place.

(9) **INSTALL CARBURETOR ADAPTER HOUSINGS** (fig. 64). Install the carburetor adapter housings on each end of the cylinder heads, using new gaskets (G104-15-93833). The rear housing differs from the front in that it has two holes in the throttle plate lever. Secure each housing to the cylinder heads with six safety nuts and flat washers. Use box offset wrench (41-W-639-850) for tightening the nuts located behind the heater flanges.

(10) **INSTALL CARBURETOR ADAPTER HEATER PIPE** (fig. 64)
NOTE: Four heater pipes are used and are connected between the carburetor adapter housings and the exhaust manifolds. The four pipes vary in length and shape, therefore, they must be tried in place when selected for installation. Use a new gasket (A-244721) and attach the lower end of one carburetor heater pipe to the exhaust manifold, using three brass nuts and flat washers. Lock the nuts with wire. Use a new gasket (No. G104-16-93837) and attach the upper end of the carburetor adapter housing with cap screws, and lock the cap screws with wire. Repeat the above procedure for the other three carburetor heater pipes.

ENGINE DESCRIPTION, DATA AND MAINTENANCE IN VEHICLE

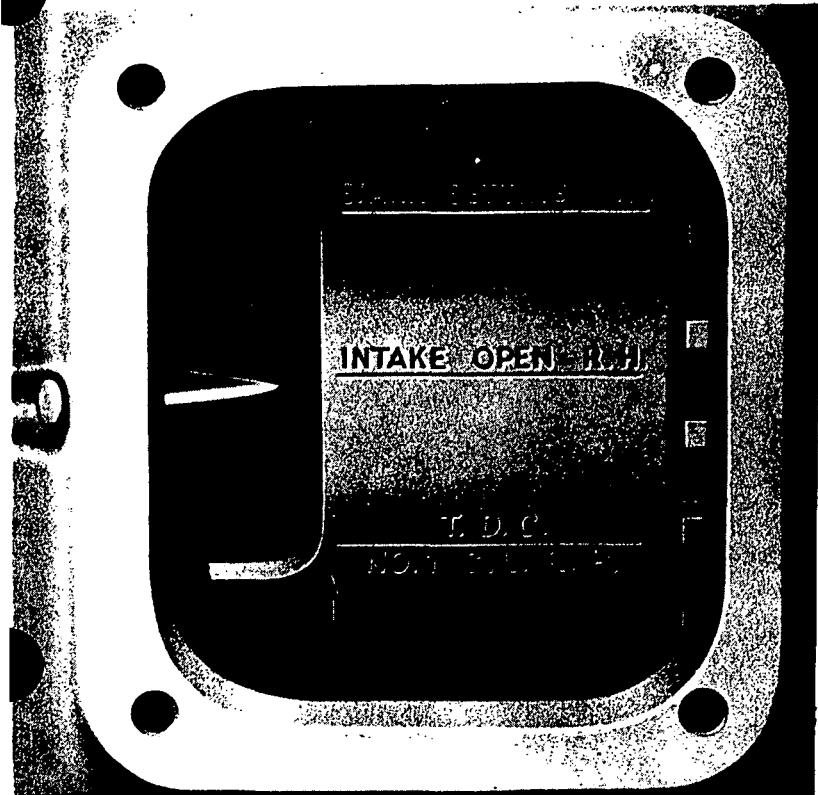

RA PD 28039

Figure 72—Flywheel Timing Marks for Camshaft Timing

(11) **INSTALL CAMSHAFT HOUSINGS** (fig. 62). Use new inner gaskets (G104-15-93812) and outer gaskets (G104-15-93810) (right) or (G104-15-93811) (left) on the top of both cylinder heads. Place the housing over the studs and secure it with $\frac{1}{4}$ -inch safety nuts. Use copper washers (G104-15-93742) under all nuts on the top of the housings, and steel flat washers under the remainder of the nuts. The spark plugs and the spark plug wires are to be installed later, therefore, the spark plug covers must not be secured to the housings at this time. **CAUTION:** *Corks should be inserted in the spark plug holes to prevent dirt or other foreign material from falling into the cylinders.*

(12) **INSTALL WATER OUTLET MANIFOLDS** (fig. 62). **NOTE:** *The manifolds are right and left; however, it is possible to install them on the wrong side of the engine. For proper installation, the manifolds should tilt toward the camshaft housings. Use new gaskets*

TANK, MEDIUM, M4A3

(G104-15-93880) and secure the manifolds to the cylinder heads with safety nuts.

(13) **INSTALL SPARK PLUGS, WIRES AND CONDUIT ASSEMBLIES** (fig. 88). Insert the four spark plug wires through the hole in the top of the camshaft housing and secure the conduit mounting flanges to the housing with four safety nuts. This same procedure applies for both of the assemblies. Install the spark plugs in the cylinder head with the special wrench (41-W-3336-300). Use socket spark plug wrench (41-W-3336-300) for tightening the spark plug wire terminals on the spark plugs. Place the camshaft housing cover and gasket (G104-15-93813) on the camshaft housing and install the washers (G104-15-93742) and nuts.

(14) **INSTALL FUEL PUMP** (fig. 62). Attach the fuel pump over the studs on the left-hand camshaft housing, and secure it with two safety nuts and flat washers.

(15) **INSTALL CARBURETORS** (fig. 62). Place the carburetor spacers, carburetors and air intake manifold on the engine. Secure each carburetor to the carburetor adapters with four safety nuts and flat washers. Connect the degasser wires to the degassers.

(16) **CONNECT FUEL LINES**. Connect the two carburetor fuel lines and fuel inlet line to the fuel pump.

(17) **INSTALL THROTTLE ROD ASSEMBLY** (fig. 92). Install the center bracket on the studs at the top center of the right-hand cylinder head and secure it to the cylinder head with two safety nuts. Both throttle rods which attach to the throttle plate arm of the carburetors must be adjusted to $16\frac{5}{8}$ inches long (measure from the center of the ball to the center of the pin hole at the other end of the rod). Attach the ball joint stud to the carburetor arm and lock the ball stud with a lock nut. Attach the other end of the rods to the arm at the center bracket with a clevis pin. Secure the clevis pins with cotter pins. Hook the spring as shown in figure 92.

(18) **INSTALL GOVERNOR** (fig. 64). Use a new gasket on the mounting flange of the governor and place the governor over the studs at the rear end of the right camshaft housing. (It may be necessary to turn the governor shaft slightly in order to line up the splines on the shaft with the splines in the camshaft.) Secure the governor to the housing with six safety nuts and flat washers. Adjust the connecting link between the governor arm and the arm on the carburetor adapter so the throttle plates are wide open when the engine is at a standstill. Attach the link to the throttle plate arm and the governor arm and lock the ball joints with cotter pins. Adjust the length of the engine speed governor throttle rod (fig. 92) so that the throttle arms in both the front and rear adapters are against the

ENGINE DESCRIPTION, DATA AND MAINTENANCE IN VEHICLE

ps. After the proper length is attained, connect the rods to the arms with clevis pins and secure with cotter pins.

(19) **INSTALL TACHOMETER DRIVE UNIT** (fig. 64). If the tachometer drive unit was removed from the camshaft cover, use a new gasket and install the assembly over the studs at the rear end of the left-hand camshaft housing. (It may be necessary to turn the tachometer shaft slightly so the splines on the quill will engage with the splines in the end of the camshaft.) Secure the tachometer drive assembly to the housing with four safety nuts.

(20) **INSTALL EXPANSION TANK** (fig. 77). Position the expansion tank on the bulkhead and install the four cap screws and lock washers.

(21) **INSTALL HOSE** (fig. 77). Install the hose that connects the water manifolds and radiator and tighten the hose clamps. Install the hose that connects the water manifolds and expansion tank and tighten the hose clamps.

(22) **INSTALL JUNCTION BOX** (fig. 77). If the junction box was removed from the left-hand camshaft cover, secure it to the cover with four safety nuts. Connect the small conduit bracket at the top under side of the box with two screws. Connect the two large conduits to the junction box.

(23) **FINAL STEPS** (fig. 64). Install the drain plug and lock in the water pump. Install the coolant in the cooling system. Make sure the expansion tank cap gasket No. A-248397 is present and is not damaged. Install the cap. Remove the oil filler pipe cap No. A-296548 and install the specified grade of oil. Replace the cap. Close the engine compartment rear door and install the three cap screws. Install the engine compartment floor plate (par. 64 p). Install the engine compartment front cover. Close and fasten the engine compartment doors.

59. OIL PAN.

a. **Description** (fig. 73). The engine oil pan is an aluminum casting and the assembly includes an oil screen secured to the bottom of the pan, an oil pressure regulator, and an oil relief valve, all of which are accessible only when the pan is removed from the engine. Two oil baffles are provided in the oil pan to hold the oil at the bottom of the pan when the vehicle is operated on steep inclines. A disk-type oil filter (hydraulically operated by means of the engine oil pressure) is located in the oil pan. The filter is accessible for removal from the outside of the pan.

b. Removal.

(1) **PRELIMINARY STEPS.** Remove the engine compartment floor plate (par. 63 d). Open the engine compartment rear door

TM 9-759

59

TANK, MEDIUM, M4A3

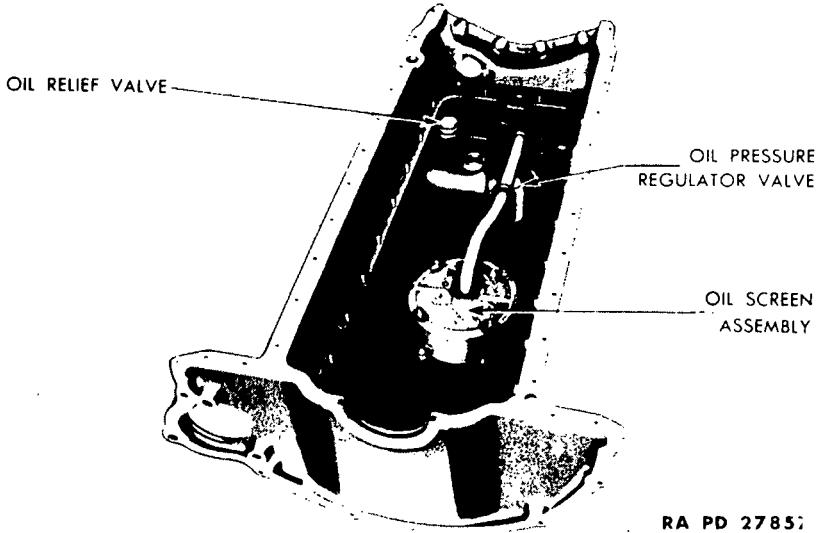

Figure 73—Engine Oil Pan Assembly

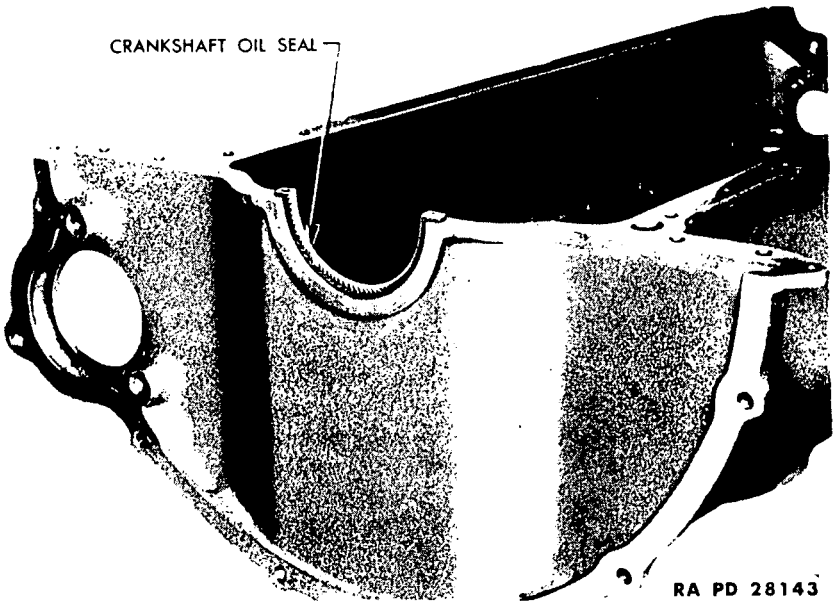

Figure 74—Crankshaft Oil Seal

ENGINE DESCRIPTION, DATA AND MAINTENANCE IN VEHICLE

par. 63 c). Place a pan with an 8-gallon capacity or better under the oil pan drain plug and remove the plug (G104-17-40482).

(2) **REMOVE OIL PUMP** (fig. 64). Remove the four nuts holding the oil pump to the oil pan and remove the pump. It may be necessary to tap the body of the pump lightly to release it from the gasket and the driving quill.

(3) **REMOVE OIL PAN**. Remove the 28 nuts holding the pan to the cylinder block and remove the pan. Remove the gasket and crankshaft oil seal.

c. Installation.

(1) **INSTALL CRANKSHAFT OIL SEAL** (fig. 74). The crankshaft oil seal included in oil pan gasket set (A-414701) must be soaked in engine oil for approximately two hours before installation. Press the seal firmly into the groove in the oil pan. The ends of the seal must extend above the machined surface of the oil pan on equal height on each side as shown in figure 74.

(2) **INSTALL OIL PAN** (fig. 63). Insert a rubber seal (G104-17-82946) on the oil tube. Place the oil pan gaskets in position on the cylinder block. Install the oil pan and secure it to the cylinder block with 28 safety nuts with flat washers.

(3) **INSTALL OIL PUMP** (fig. 64). Use a new gasket and place the pump over the studs. The engine may have to be turned over slowly so the spline on the pump shaft will line up with the splines in the accessory gear worm gear shaft. Secure the pump to the oil pan with four safety nuts.

(4) **FINAL STEPS**. With the oil pan drain plug gasket (G-104-15-93843) in place on the plug, install and tighten the oil pan drain plug. Install 8 gallons of specified grade oil. Install the engine compartment floor plate (par. 64 p). Close the engine compartment rear door (par. 64 q).

60. OIL PUMP.

a. **Description** (fig. 64). The oil pump is a gear-type pump, mounted at the rear of the oil pan. It is driven by the lower camshaft worm gears by means of a splined quill connecting the pump shaft with the left-hand worm gear.

b. **Removal**. Remove the engine compartment floor plate (par. 63 d). Place a pan with at least an 8-gallon capacity under the oil pan drain plug, and remove the plug. Remove the four nuts holding the oil pump to the oil pan, and remove the pump. It may be necessary to tap the body of the pump lightly to release it from the gasket and the driving quill.

TM 9-759

60-61

TANK, MEDIUM, M4A3

c. **Installation.** Use a new gasket, and place the pump over the studs. The engine may have to be turned over slowly so that the splines on the pump shaft will line up with the splines in the accessory gear worm gear shaft. Secure the pump to the oil pan with four safety nuts. Install the engine compartment floor plate (par. 64 p). Install 8 gallons of the specified grade oil.

61. OIL FILTER.

a. **Description** (fig. 75). The oil filter consists of a stack of wheel-shaped disks, separated from each other by spoked spacer pieces, and is mounted on a rotatable spindle. Located adjacent to this stack of disks and spacers is a stack of cleaner blades mounted on a rod in such manner that each cleaner blade enters the space between adjacent disks. Solids, too large to pass between the disks, remain on the outer surface until such time as the disks are rotated past the cleaner blades. Accumulated solids are removed from the surface by the combing action of the cleaner blades, and collect

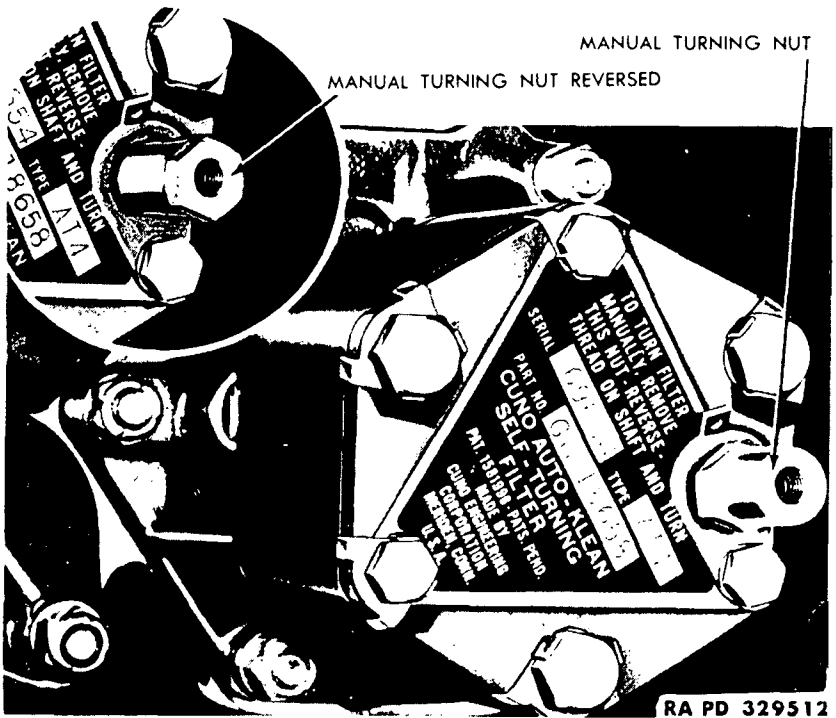

Figure 75—Oil Filter

ENGINE DESCRIPTION, DATA AND MAINTENANCE IN VEHICLE

sump around the filter. The filter disks are rotated by a hydraulic motor operated by oil pressure from the engine. The oil filter is located on the right side of the oil pan at the rear, accessible through the engine compartment rear door.

b. **Operation Check.** To check the operation of the filter, remove the manual turning nut, turn end for end, and reinstall on the shaft from which it was removed (fig. 75). Run the engine at speed which shows an oil pressure of approximately 30 pounds. The manual turning nut will rotate very slowly if the filter is operating. Mark the nut and check position of this mark, after the engine has been running for 5 minutes, to see if it has rotated. After the check is made, reinstall the manual turning nut in the original position, and secure it with lock wire. If the filter nut fails to turn, remove the unit from the engine for examination or replacement.

c. **Removal** (fig. 75). Remove the engine compartment floor plate (par. 63 d). Remove the six nuts from the mounting flange of the oil filter, and remove the oil filter (G104-15-82930) from the engine oil pan.

d. **Installation.** Use a new oil filter gasket (G104-15-93840) and set it in place so that the oil hole in the gasket lines up with the drilled oil hole in the oil pan. Insert the oil filter in the opening

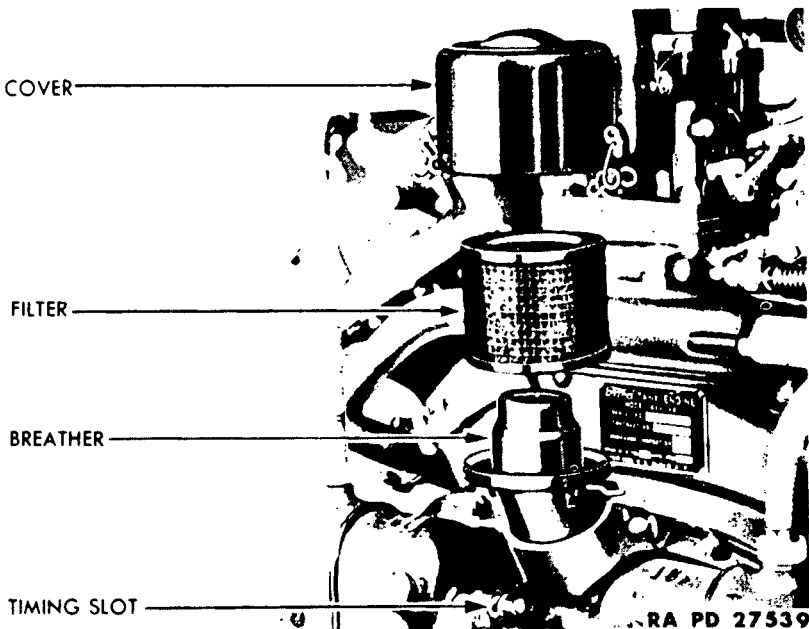

Figure 76—Crankcase Breather

TANK, MEDIUM, M4A3

provided in the oil pan. Secure the filter to the oil pan with safety nuts. Install the engine compartment floor plate (par. 64 p).

62. CRANKCASE BREATHER.

a. **Description** (fig. 76). The crankcase breather is located directly above the water pump, accessible either from above or through the engine compartment rear door.

b. **Service Filter Element** (fig. 76). To remove the filter element (B-258269) for cleaning, release the two holding clips, and lift off the cover. Lift off the filter element. The filter should be cleaned by washing it in dry-cleaning solvent. Blow out with compressed air, and when dry, dip in seasonal grade engine oil. Reinstall the filter element and the cover.

Section XV**ENGINE REMOVAL AND INSTALLATION****63. REMOVAL.**

a. **Turn Battery Master Switch Off.**

b. **Remove Covers From Engine Compartment.** Raise both engine compartment doors. Remove the seven cap screws which hold the rear cover plate to the top of the hull, and lift it from the hull with a chain fall or hoist. Remove the 10 cap screws which hold the front cover to the top of the hull and lift the cover from the hull.

c. **Open Rear Door of the Engine Compartment.** Remove the three cap screws which hold the door closed, and open the door. Raise the radiator air baffle, and latch it in raised position. If the vehicle is not equipped with an air baffle latch, raise the air baffle, then open the door and leave the air baffle rest on the door.

d. **Remove Engine Compartment Floor Plate.** Remove the lock wires from the cap screw heads which hold the floor plate to the hull. Remove the cap screws, leaving one at each corner of the floor plate. Place a jack at the center of the plate, and remove the remaining cap screws, then lower the floor plate with a jack.

e. **Drain Cooling System** (fig. 78). Remove the drain plug at the bottom of the water pump and drain the cooling system.

f. **Drain Engine Oil.** Remove the drain plug at the bottom of the engine oil pan, and drain the oil (a container holding 8 gallons or more is required).

ENGINE REMOVAL AND INSTALLATION

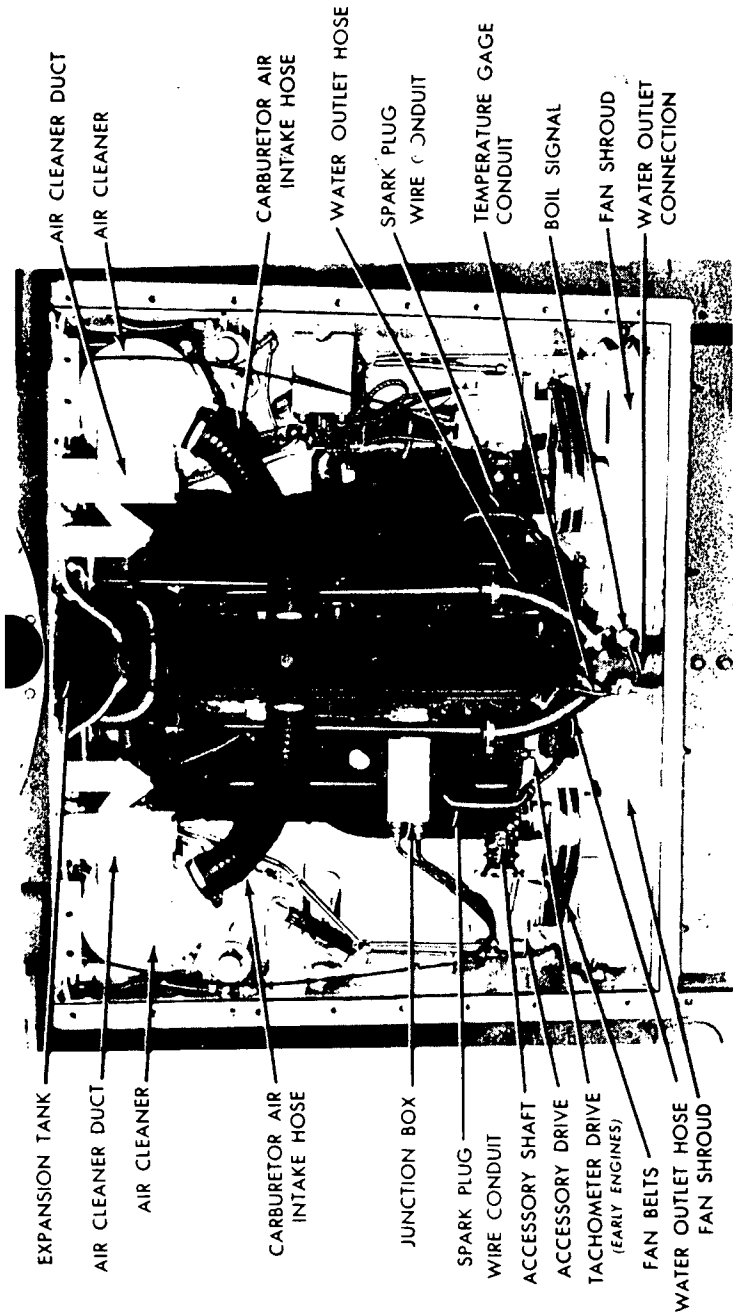
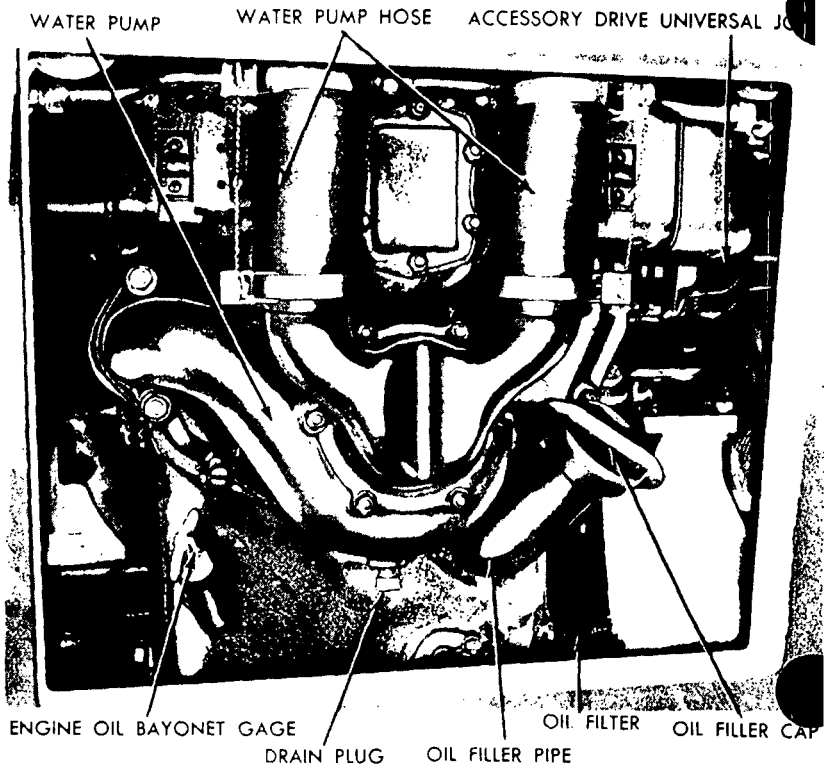

Figure 77—Typical Engine Compartment Viewed From Above

TANK, MEDIUM, M4A3



RA PD 329220

Figure 78—Early Engine Viewed Through Rear Door

g. **Remove Oil Filler Pipe** (fig. 78). If the oil filler pipe is located at the rear of the engine, remove the three nuts which hold the oil filler pipe to the engine oil pan. Remove the filler pipe.

h. **Remove Water Pump and Radiator Expansion Tank.** Remove the four nuts that secure the water pump to the engine. Disconnect the water pump hose from the water pump. Remove the water pump. Remove the cooling system expansion tank and hose. Remove miscellaneous electrical connections. Loosen the two knurled nuts at the two conduits leading to the junction box at the left side of the engine (fig. 77). Pull the two conduit plugs out of the sockets. Disconnect the temperature gage wires at the upper connection at the radiator end. Disconnect the cranking motor cable at the cranking motor. Disconnect the oil pressure gage connection at the right rear end of the engine oil pan. Disconnect the ground wire (running from each magneto to the ignition switch) at each magneto, then with two short lengths of wire, ground the

ENGINE REMOVAL AND INSTALLATION

terminal of each magneto to the cover retainer screws. This will prevent the possibility of the engine starting in the event it is turned over. Disconnect the wire from the oil float level gage (engine unit) at the right-hand side of the oil pan if vehicle is equipped with engine oil level gage.

i. Remove Inlet and Outlet Connections From Radiator (fig. 77). Loosen the clamps and remove the two top radiator hose. Remove the four cap screws from the radiator upper and lower water connections. Remove the connections, including the thermostat and gasket.

j. Remove Fan Belts (fig. 77). Loosen the four bolts securing each accessory drive housing to the hull. Raise the housings to provide slack for the belts, and remove the belts.

k. Remove Fan and Shroud Assemblies and Accessory Shafts (fig. 77). Remove the six bolts holding each fan shroud in place. Remove the fan and shroud assembly from the engine compartment. Remove the four bolts from the flange of the universal joint at each end of the accessory drive shaft. Remove the accessory shafts.

l. Disconnect Fire Extinguisher Nozzles. Remove the pipe connections from the upper fire extinguisher nozzle on the right- and left-hand sides of the engine compartment. Remove the two cap screws from each fire extinguisher nozzle bracket. Remove the nozzle and brackets.

m. Disconnect Fuel and Primer Lines. Turn off all of the fuel shut-off valves (figs. 9 and 10). Disconnect the fuel line from the fuel pump. Disconnect the primer line at the left side of the bulkhead.

n. Disconnect Throttle Rod. Disconnect and remove the throttle control rod running from the throttle cross shaft on the bulkhead to the throttle control bracket in the center of the engine.

o. Remove Air Cleaners and Tubes. Remove the two air cleaners and tubes (par. 76 b). If the air cleaners are located in the fighting compartment, do not remove them, just remove the air cleaner tubes.

p. Disconnect Rear Universal Joint and Clutch Throw-out Clevis. Remove the canvas cover and the eight bolts which connect the universal joint to the clutch shaft flange. Remove the clevis pin from the clutch release arm.

q. Remove Exhaust Pipes and Disconnect Engine Mounts From Support Brackets. Remove the six bolts that secure the exhaust pipes to the exhaust manifolds on each side of the engine.

TANK, MEDIUM, M4A3

Remove the exhaust pipes. Remove the four bolts from both engine rear support brackets, and the two rear bolts from both engine front support brackets. Remove the plates from the clutch housing cover which are directly in front of the engine front support brackets, then remove the two front bolts from both support brackets (fig. 80).

r. **Remove Engine From Hull** (fig. 79). Attach an engine sling (41-S-3831) to the four lifting eyes on the engine (fig. 79). Remove the engine from the hull with a chain fall or hoist. Figure 4 shows adjustable lifting sling, and the position of the engine for removal. It will be necessary to adjust the sling to tilt the engine to obtain a clearance at the clutch housing and magnetos. After the engine is removed, make sure that both magnetos are grounded, to eliminate the possibility of the engine starting if it should be turned over while out of the vehicle.

s. **Remove Exhaust Pipes From Rear of Hull.** Remove the five bolts from both the external exhaust pipes on the rear of the hull, and remove the exhaust pipes.

64. INSTALLATION.

a. **Set Engine in Hull.** If a new or replacement engine is to be installed, the water pump assembly and the oil filler pipe are to be removed from the engine before attempting the installation. Remove the short lengths of wire from each magneto ground. Attach the engine lifting sling (41-S-3831) to the four lifting eyes on the engine (fig. 78). Attach a chain fall or hoist, raise the engine, and adjust the lifting sling to tilt the engine to approximately the angle shown in figure 79. Enter the engine into the hull with the front end pointing to the left-hand front corner of the engine compartment. Lower the engine into place, adjusting the lifting sling as necessary to obtain clearance at the clutch housing and magnetos. Line up the bolt holes in the engine mounts and supports.

b. **Install Exhaust Pipes and Connect Engine Mounts.** Using new bolts and gaskets, assemble the exhaust pipe to the exhaust manifold on each side of the engine. Using new packing, install the five bolts securing each external exhaust pipe to the rear of the hull. Install the four bolts securing the engine mounts to both the engine rear support brackets, and the two rear bolts in both engine front support brackets. Install the two front bolts in both front support brackets, working through the opening in the clutch housing cover on the bulkhead in the fighting compartment (fig. 80).

c. **Connect Rear Universal Joint and Clutch Throw-out Clevis.** Install the eight bolts which connect the universal joint to the clutch shaft flange. Install the clevis pin which connects the clutch release

ENGINE REMOVAL AND INSTALLATION

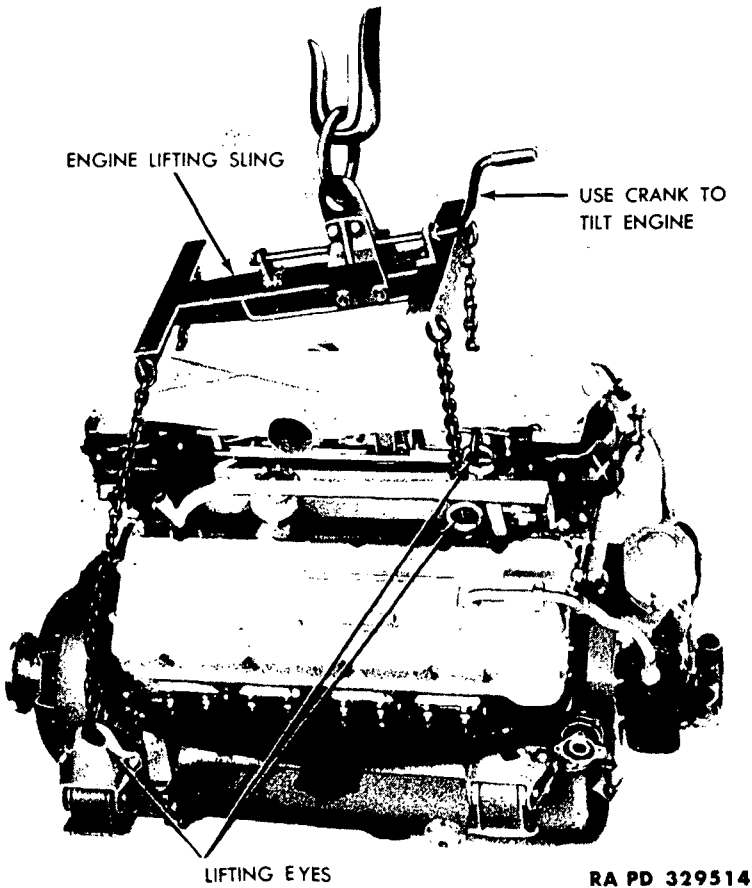

Figure 79—Engine Lifting Sling

arm to the clutch release clevis. Adjust the clutch (par. 110). Install the canvas around the clutch housing.

d. **Install Air Cleaners.** If the air cleaners were removed, install the two air cleaners and tubes (par. 76 b).

e. **Connect Throttle Rod.** Connect the throttle rod which runs from the throttle cross shaft on the bulkhead to the throttle control bracket at the center of the engine. Adjust the linkage (par. 77 b), if required.

f. **Connect Fuel and Primer Lines.** Connect the fuel line to the fuel pump. Connect the primer line at the left side of the forward carburetor, and the primer lines running to each intake manifold.

TANK, MEDIUM, M1A3

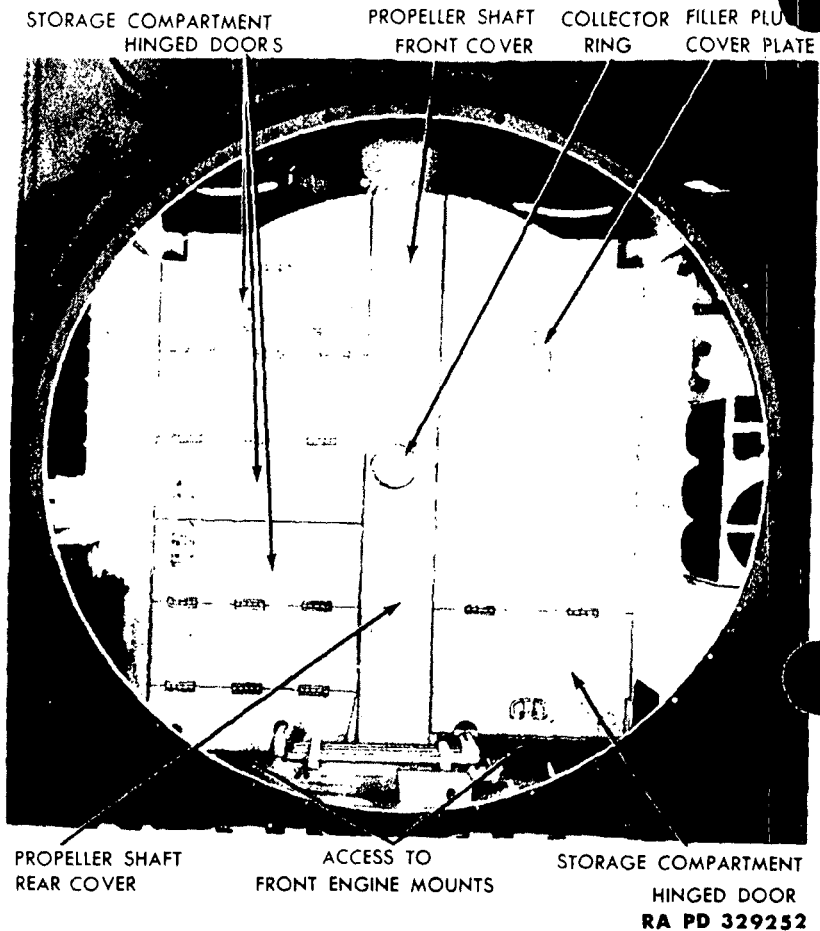

Figure 80—Typical Fighting Compartment Floor Plates

g. **Connect Fire Extinguisher Nozzle.** Install the upper fire extinguisher nozzles and brackets on both sides of the engine compartment. Connect the fire extinguisher pipes to the nozzles.

h. **Install Fan and Shroud Assemblies and Accessory Shafts** (fig. 77). Place fan and shroud assemblies in position in front of the radiator. Place a new felt gasket between shroud and holding plate. Place a rubber bushing and collar in the mounting holes and install six bolts, securing each fan shroud to the hull plate. Place the right and left accessory drive shaft in position, and install the four bolts in the flanges of the universal joint at each end of the accessory drive shafts.

ENGINE REMOVAL AND INSTALLATION

i. **Install Fan Belts.** Loosen the four bolts securing each accessory drive housing to the hull. Raise the housings to provide slack for the belts. Install the belts and adjust them to the proper tension (par. 86 b).

j. **Install Inlet and Outlet Connections to Radiator** (fig. 77). Install the radiator upper and lower water connections including the thermostat and gaskets on the radiator. Install the two top radiator hose, and tighten the clamps.

k. **Connect Miscellaneous Electrical Connections.** Connect the oil pressure gage connection at the right rear end of the engine oil pan. Connect the cranking motor cable to the cranking motor. Install the two conduits to the junction box on the left side of the engine. Connect the temperature gage and oil signal wires to the engine units. If equipped with engine oil level gage, connect the wire to the gage engine unit located on the right-hand side of the engine oil pan.

l. **Install Water Pump and Radiator Expansion Tank.** Install the water pump with gaskets on the four studs on the engine, and secure it with four fiber insert nuts. Install the two hose running from the water pump to the radiator lower water connection, and tighten the hose clamps. Install the expansion tank (par. 89 c).

m. **Fill Cooling System.** Install the drain plug in the water pump (fig. 78), and fill the cooling system to the level of the petcock in the radiator upper water connection (fig. 99).

n. **Install Oil Filler Pipe.** Install the oil filler pipe, and secure it with three fiber insert nuts.

o. **Fill Engine Oil Pan With Oil.** Flush out engines which have been rebuilt. Fill the oil pan with 6 or 8 gallons of SAE 10 engine oil. Run the engine for 15 minutes at 1,000 revolutions per minute, then drain the SAE 10 oil (flushing oil) from the oil pan, and install the drain plug in the oil pan. Remove the oil filter from the oil pan, and clean the filter element by washing it in dry-cleaning solvent. Turn the element by means of the manual turning nut, while cleaning, until all foreign material has been removed. When thoroughly clean, allow to dry. **NOTE: Do not blow compressed air on the element.** Reinstall the filter in the oil pan and refill with 8 gallons of seasonal grade engine oil.

p. **Install Engine Floor Plate.** Place a jack at the center of the floor plate, and raise the plate against the bottom of the hull. Install a cap screw at each corner of the plate. Remove the jack, install the remaining cap screws, and secure with locking wire.

TANK, MEDIUM, M4A3

q. Close and Fasten Rear Door of Engine Compartment. Raise the air baffle, and close the engine compartment rear door. Install and tighten the three cap screws securing the door to the rear of the hull.

r. Set Carburetor Adjustment.

(1) **IDLE FUEL ADJUSTMENT.** As shown in figure 89, idle fuel adjustments are provided on each carburetor. The idle fuel adjustments on these carburetors are extremely uniform, and can be adjusted with the engine hot or cold. Make the adjustment with the engine stopped. Turn each idle adjusting screw clockwise until it seats lightly, then turn out one-quarter turn from its closed position. A short (stub) screwdriver will be required for making this adjustment on the forward carburetor.

(2) **IDLE SPEED ADJUSTMENT** (fig. 89). Start engine and allow it to run until it reaches normal operating temperature (135° F). On the 75-mm dry storage vehicles, back off the idle speed adjustment at each carburetor until the engine speed is below 500 revolutions per minute. Set the idle speed adjustment at one of the carburetors until the engine speed is 500 revolutions per minute. Set the idle speed adjustment at the other carburetor until the speed just starts to increase, then back off the adjustment slightly.

s. Adjust Throttle Linkage.

(1) **HAND THROTTLE.** Check the hand throttle button free movement, and adjust if required. The hand throttle must have $\frac{1}{8}$ -inch free movement before the carburetor throttle plates start to open. Loosen the two bolts which hold the cover over the throttle cross shaft, and remove the cover. Remove the clevis pin from the hand brake clevis on the rear of the hand brake rod, and adjust the clevis so that the throttle button has approximately $\frac{1}{8}$ -inch free movement. Install the clevis pin in the brake rod clevis.

(2) **FOOT THROTTLE.** The foot throttle pedal must also have a slight free movement before the carburetor throttle plates start to open. If not, adjust the foot throttle and the throttle linkage on the engine as outlined in paragraph 77.

t. Check Instruments and Gages. Start the engine and run it at various speeds, observing all instruments and gages on the instrument panel. If any of the gages or instruments show an abnormal reading, the cause must be determined and the condition corrected.

u. Check Engine for Water and Oil Leaks. With the engine running, check all water connections for leaks. Inspect all engine gaskets for external water or oil leaks.

IGNITION SYSTEM

v. **Drive Vehicle.** Drive the vehicle, and observe clutch action. Adjust the clutch if necessary (par. 110). Observe the engine performance in general.

w. **Set Governor** (fig. 64). Start the engine and run it until it reaches normal operating temperature (135° F). Increase the speed of the engine, and adjust the throttle governor to control top speed of the engine at 2,800 revolutions per minute without load. Turn the adjusting nut on the governor clockwise to increase the speed, or counterclockwise to decrease the speed. After the proper adjustment has been obtained, place a seal on the adjustment nut.

x. **Install Covers on Engine Compartment** (fig. 24). With a chain or hoist, place the front cover on the engine compartment, and install the cap screws. With a chain fall or hoist, place the rear cover in position, and install the cap screws while the doors are open. Close and fasten the engine compartment doors.

Section XVI

IGNITION SYSTEM

65. DESCRIPTION AND DATA.

a. **Description.** The ignition system consists of two magnetos, aircraft-type spark plugs, and the necessary connecting high-tension wires. The ignition is turned off when the magnetos are grounded by means of the ignition switch on the instrument panel. If at any time the ground wires running from the magnetos to the ignition switch were broken, the ignition could not be turned off with the ignition switch. On the other hand, if these wires become shorted, it would be impossible to turn the ignition on with the ignition switch. The numbering of the cylinders and the firing order are shown in figure 33.

b. Data.

Magneto:

Make Bosch

Model:

Right-hand MJF4A-308, MJF4B-314
or MJF4B-316

Left-hand MJF4A-307, MJF4B-311
or MJF4B-315

Breaker point gap 0.014 to 0.016 in.

Direction of rotation:

Right-hand rotor Clockwise

Left-hand rotor Counterclockwise

Rotor speed 1/2 crankshaft speed

TANK, MEDIUM, M4A3

Numbering of cylinders from rear to front:

Right bank	1-2-3-4
Left bank	1-2-3-4
Firing order	1R, 2L, 3R, 1L, 4R, 3L, 2R, 4L
Spark advance (range 600 to 1,400 rpm)	Automatic
Spark plugs (type)	Champion C88-S
Spark plug gap:	
Manufacturing limit	0.011 to 0.014 in.
Service maximum limit	0.030 in.

66. MAGNETOS.

a. Description. Two magnetos (C-124412-B) (left) and (C-124412-A) (right) are used, one firing the cylinders in the right bank, and the other firing the cylinders in the left bank. Right and left throughout this book is determined when looking at the engine from the rear of the vehicle, looking toward the front. The automatic spark advance governor is a part of the engine and is not a part of the magnetos. One governor assembly advances the spark of both magnetos together.

b. Magneto Replacement.

(1) **PRELIMINARY INSTRUCTIONS.** Before removing either magneto, observe the position of the rotor arrow in the center of the distributor plate (fig. 83). If the engine has not been cranked during the time the magnetos are off the engine, the replacement magneto is installed with its arrow pointing in this same direction. Then the only ignition timing required will be to adjust the magnetos by means of the adjusting slots in the magneto mounting flange as outlined in paragraph 67 c. If the engine has been cranked while the magnetos are off the engine and the timing is lost, a major timing adjustment will be required (par. 67 d).

(2) **OPEN ENGINE COMPARTMENT DOORS.** Open the doors over the engine compartment. Open the engine compartment rear door.

(3) **REMOVAL (EITHER MAGNETO).** Remove the four screws securing the breaker point inspection cover, and remove the cover. Remove the four screws securing the magneto circular plate and remove the plate. Remove the ground wire terminal screw. Unscrew the hexagon nut securing the ground wire conduit to the magneto housing. Remove the ground wire and conduit from the magneto. Remove the four screws securing the four ignition (high-tension) wires to the magneto distributor plate and lift the wire terminals out of the recesses. Unscrew the knurled nut securing the ignition wire conduit to the magneto, and remove the conduit and wires from the magneto. Remove the lock wire and upper and

IGNITION SYSTEM

Lower nuts securing the magneto to the engine and remove the magneto.

(4) **INSTALLATION (EITHER MAGNETO).** If the engine has not been turned over while the magnetos were removed, the magnetos must be installed with the rotor arrow (fig. 83) pointing to the same terminal as when removed. If the engine has been turned while the magnetos are off the engine, proceed as outlined in paragraph 67 following. Place a new gasket (G104-15-93816) and the magneto in position and enter the groove in the magneto drive flange over the tang on the magneto drive shaft flange. Shift the magneto so that the studs are in the center of the adjusting slots of the magneto mounting flange. Install the upper and lower nuts to secure the magneto to the engine. Install the ignition wire conduit to the magneto and connect the four ignition wires to the proper terminals (fig. 83). Attach the ground wire conduit to the magneto and the ground wire to the magneto ground wire terminal. Install the circular plate and the breaker point inspection cover. Check the timing as outlined in paragraph 67, and shift the magneto in the adjusting slots if necessary.

c. Breaker Point Replacement.

(1) **REMOVAL.** Remove the magneto as outlined in subparagraph b above. Remove the four screws and lock washers from the breaker inspection plate (lower plate), and remove the plate and gasket. Disconnect the ground wire from the breaker cap. Remove the two screws and lock washers that secure the breaker cap to the distributor plate, and remove the breaker cap and gasket. Remove the cap screw and lock washer that hold the breaker arm spring to the breaker plate. Remove the cotter pin and flat washer that hold the breaker arm to the breaker plate. Lift the breaker arm off the breaker plate. Remove the adjustable bracket lock screw (fig. 84) from the breaker point bracket assembly. Lift the breaker point bracket assembly from the breaker plate.

(2) **INSTALLATION.** Slip the breaker point bracket assembly (fig. 83) into the slots in the breaker plate provided for it. When the holes are alined, fasten to the breaker plate with a screw and lock washer (fig. 84), making sure the grounding wire is also fastened with the screw to the plate. Screw the breaker spring screw and lock washer (fig. 84) part way into the breaker lever, holding bracket with an open-end wrench. Apply a liberal film of engine oil on the breaker arm stud, and slip the breaker arm (fig. 84) over it. Place the spring attached to the arm behind the breaker arm bracket, so that the slot in the spring fits over the breaker arm spring fastening screw. This item was previously screwed part way into the breaker holding bracket. At this time the contact point of the breaker

TANK, MEDIUM, M4A3

arm should be flush against the contact point in the breaker point bracket. Slip the washer over post and fasten with cotter pin. Adjust the breaker points as outlined in step (3) below. Place a new gasket and the breaker cap on the distributor plate and secure them to the distributor plate with two screws and lock washers. Connect the ground wire to the breaker cap. Install the breaker inspection plate and gasket on the magneto housing. Install the magneto as outlined in subparagraph b above.

(3) **BREAKER POINT ADJUSTMENT.** The magnetos must be removed from the engine before attempting to adjust the breaker points. Breaker points are adjusted to an opening of from 0.014 to 0.018 inch when the breaker arm fiber rubbing block rests on the high point of the cam. Adjust the breaker point bracket (fig. 83) by means of the eccentric adjusting screw (fig. 84) until the correct gap is obtained. Lock the bracket with the adjustable bracket lock screw (fig. 84). Contact points must be free from oil and grease and in proper alignment, so that the surfaces of both contacts meet squarely.

67. IGNITION TIMING AND SPARK ADVANCE GOVERNOR.

a. **Flywheel Timing Mark Data.** The flywheel marks on present production engines are 10 degrees before top dead center mark, and are stamped "SPARK SETTING R.H." for setting timing on the right-hand cylinders, and "SPARK SETTING L.H." for the left-hand cylinders (fig. 85). Early production engine timing marks are only 5 degrees before the top dead center mark, and are stamped "SPARK RETARD R.H." for setting the timing on the right-hand cylinders, and "SPARK RETARD L.H." for the left-hand cylinders. When setting the spark timing on early-production engines, the timing should be set 5 degrees in advance of the "SPARK RETARD" mark. Measure $\frac{7}{8}$ inch ahead of these marks (equivalent to 5 degrees) and scribe a mark on the flywheel. After this line has been scribed on the flywheel, ignore the marking "SPARK RETARD," and set the flywheel with the scribed mark at the pointer when timing engines with the early-type flywheel markings. In the following instructions, this scribed line will be considered as the "SPARK SETTING" mark on these early engines.

b. Procedure for Checking Timing and Governor Advance.

(1) **PRELIMINARY STEPS.** Open the doors over the engine compartment. Remove the four screws from the flywheel inspection plate on the top left side of the flywheel housing, and remove the plate. Make certain the ignition switch is off, then turn the engine by hand (fig. 81) until one of the "SPARK SETTING" timing marks is opposite the timing pointer in the opening in the flywheel housing.

IGNITION SYSTEM

ACCESSORY SHAFT UNIVERSAL JOINT

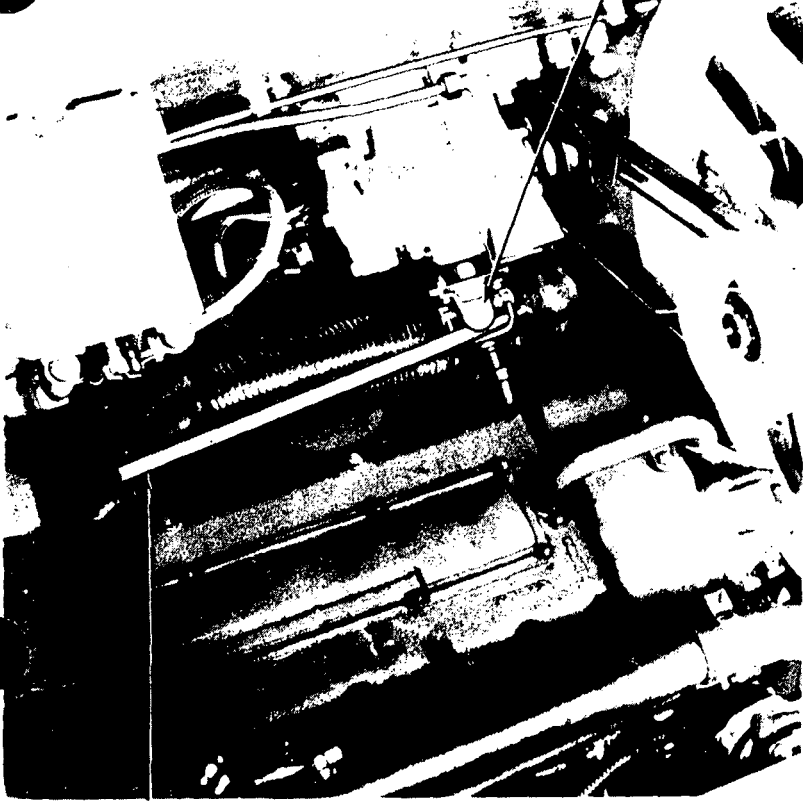

TURNING BAR

RA PD 329240

Figure 81—Turning Engine by Hand

from which the plate has been removed (fig. 85). Draw a line across the face of the flywheel at this mark with chalk. Turn the engine until the other "SPARK SETTING" timing mark appears, and draw a line at this mark with chalk. *NOTE: See instructions about earlier-type engines in regard to timing mark.*

(2) **CONNECT TIMING LIGHT.** Remove the nuts from the spark plug covers on each side of the engine, and remove the covers. Remove the spark plug wire from No. 1 spark plug in the right bank to check right-hand magneto (use No. 1 spark plug in the left-hand bank to check the left-hand magneto). To a short piece of high-tension wire, attach the connector and terminal as shown in figure 86. Insert this wire in No. 1 spark plug. Attach the high-

TANK, MEDIUM, M4A3

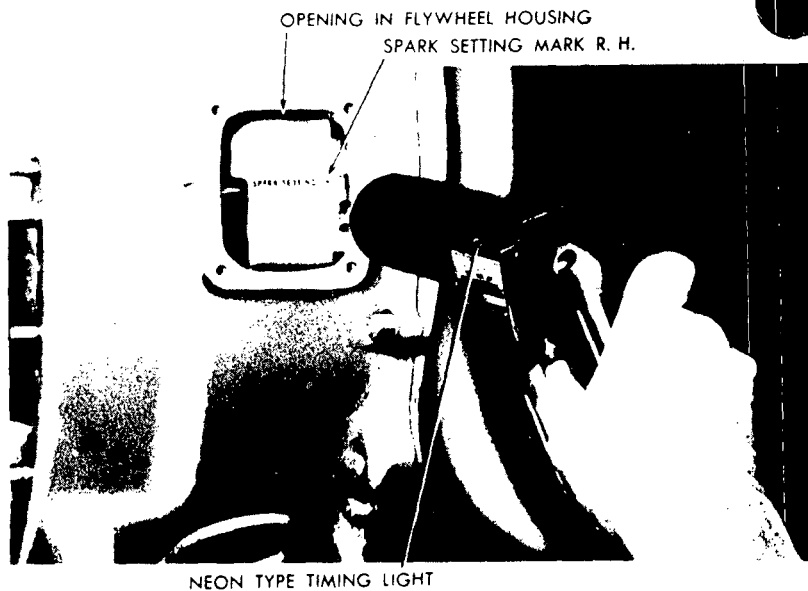

RA PD 330845

Figure 82—Timing Light (41-L-1440)

tension lead (large wire) of the timing light to the terminal of No. 1 spark plug wire, and also to the connector of the short piece of wire just inserted in the spark plug. Connect one end of a 12-foot length of insulated wire to any terminal or battery post where 24 volts are available, attach the other end to the positive (red) low-tension lead of the timing light. Connect the other low-tension lead to any convenient ground.

(3) **USE OF TIMING LIGHT.** Start the engine, and allow it to warm up. Set the engine idling speed at approximately 500 revolutions per minute. Hold the timing light over the opening in the flywheel housing so that it can flash on the chalked timing marks (fig. 82). If the chalked "SPARK SETTING" mark on the flywheel appears at the left of the pointer, the timing is advanced. If the mark appears to the right of the pointer, the timing is retarded. If adjustment is required to correct the timing, refer to step (4) below. Repeat the above procedure for the other magneto.

(4) **CHECK MAGNETO SPARK ADVANCE.** With the timing light still connected, start the engine, increase its speed, and observe the mark on the flywheel. The governor will start to advance the spark when the engine speed reaches 600 revolutions per minute, and the spark will be fully advanced when the engine speed reaches

IGNITION SYSTEM

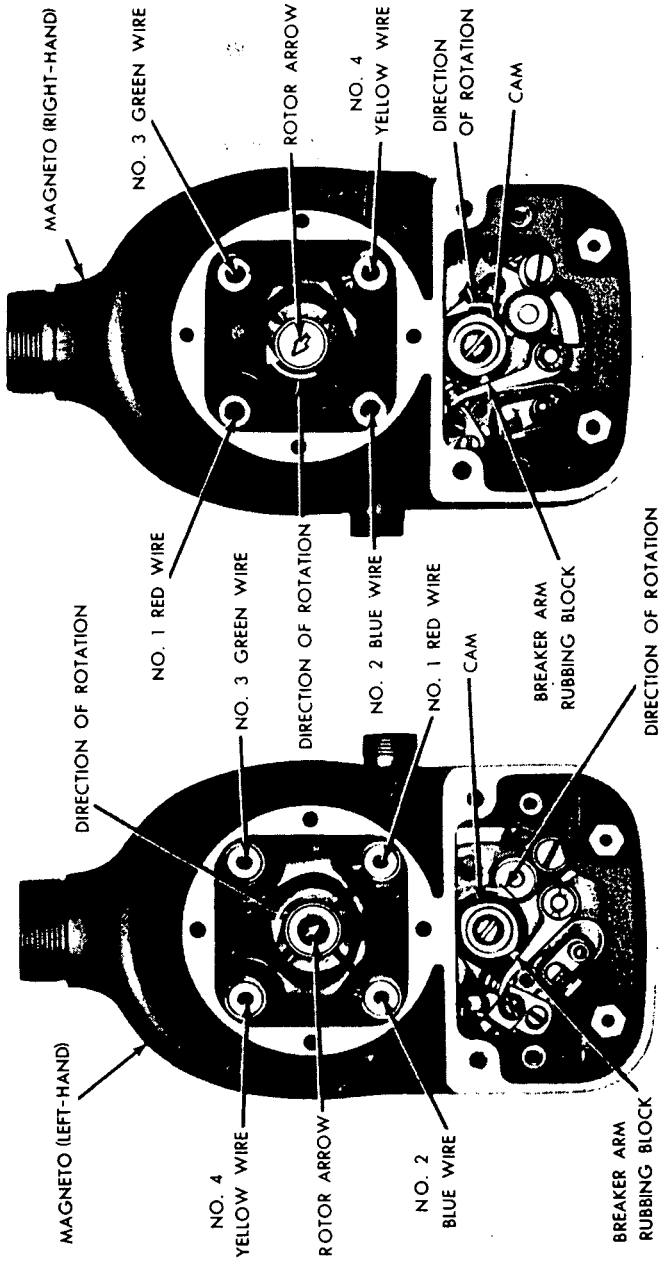

RA PD 329450

Figure 83—End View of Right-hand and Left-hand Magnetos

TANK, MEDIUM, M4A3

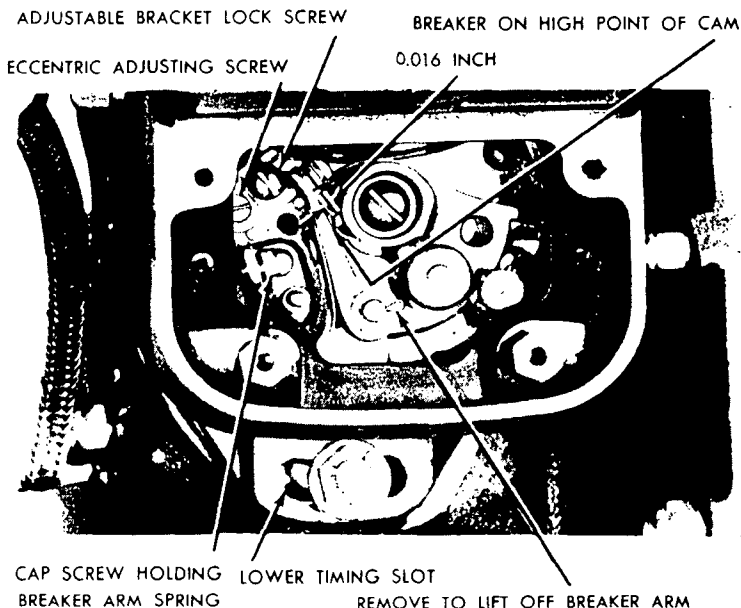

RA PD 329601

Figure 84—Magneto Breaker Point Assembly

1,400 revolutions per minute. The chalked timing mark should move to the left of the pointer as the speed of the engine increases, until the spark timing reaches maximum advance, at which time the chalked flywheel mark will be approximately $2\frac{5}{8}$ inches to the left of the pointer. If the timing mark does not change its position in relation to the pointer when the engine speed is increased, the spark governor is faulty, and should be replaced. Notify higher authority.

c. **Minor Timing Adjustment.** Remove the lock wire and loosen the upper and lower holding nuts on one magneto. Move the magneto in the adjusting slots toward the front (flywheel end of the engine) to advance the timing or toward the rear to retard the timing. Recheck the timing with the timing light as outlined in step (4) above. After the correct timing has been obtained, tighten the magneto holding nuts and secure them with locking wire. Follow the same procedure in adjusting the timing on the other magneto. Connect the wires to the spark plugs and install the spark plug cover plates. If the correct timing cannot be obtained in the range provided at adjusting slots on the magnetos, it will be necessary to reset the timing by resetting the magneto drive shaft (subpar. d below).

IGNITION SYSTEM

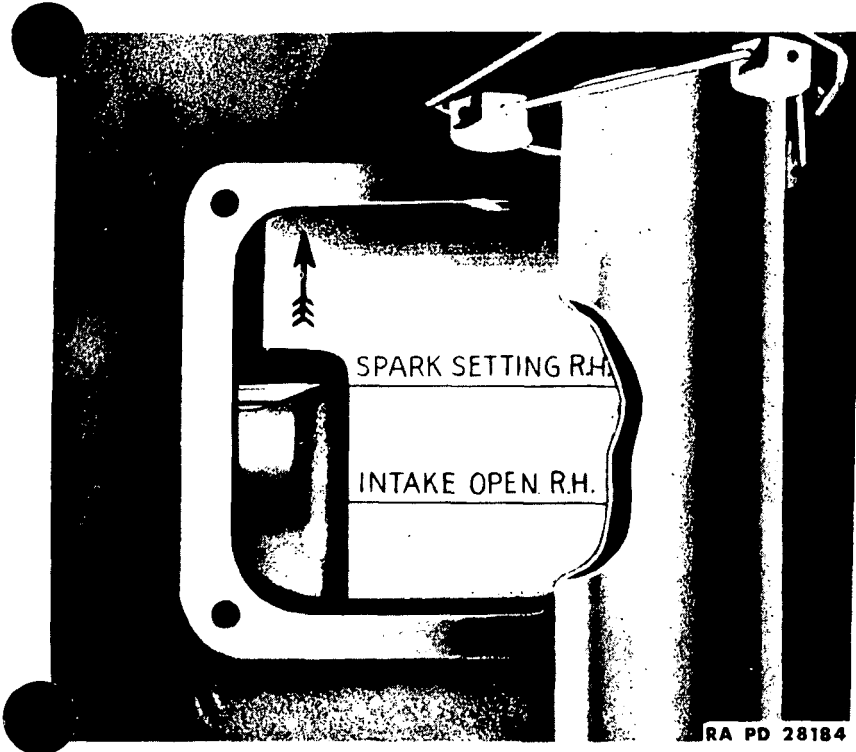

Figure 85—Flywheel Timing Marks

d. Major Timing Adjustment.

(1) **GENERAL.** A major timing adjustment consists of resetting the magneto drive shaft and is required when the correct timing cannot be obtained by the range provided by the adjusting slots in the magneto mounting flange.

(2) **SET ENGINE FLYWHEEL MARK AT POINTER.** Turn the engine in direction of rotation until the No. 1 piston on the right-hand side is on its compression stroke (use a compression gage in No. 1 cylinder spark plug hole to determine the compression stroke) and the "SPARK SETTING R.H." mark or the scribed mark (subpar. b (1) above) on the flywheel is at the pointer (fig. 85).

(3) **SET TIMING.** Remove the left-hand magneto (par. 66). Loosen the two nuts (do not remove the nuts) which secure the right-hand magneto to the engine. Loosen the nut which secures the left-hand drive flange (C, fig. 87) on the magneto drive shaft and separate the drive flange from the serrations on the magneto

TANK, MEDIUM, M4A3

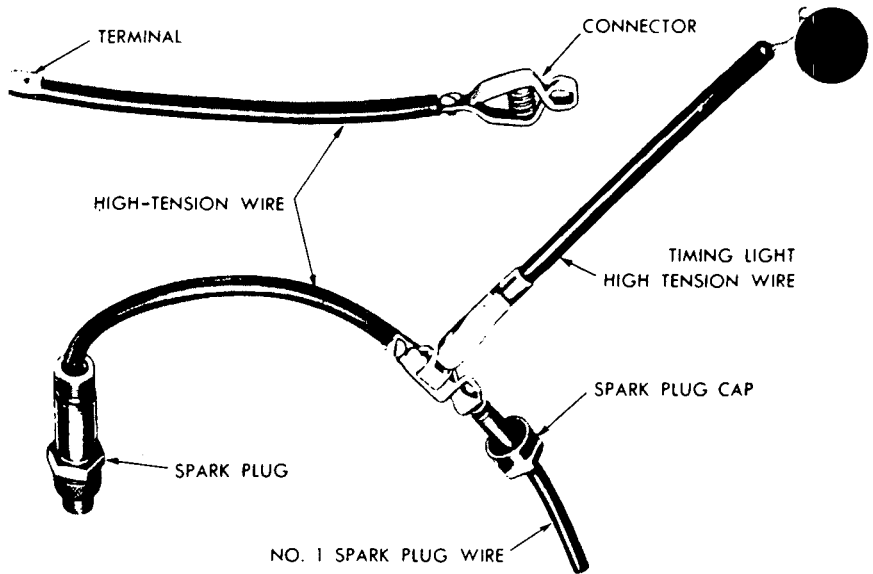

RA PD 28064

Figure 86—Timing Light Connections

drive gear (D, fig. 87). Remove the magneto drive gear inspecting cover and gasket. Remove the circular cover and the breaker cover from each magneto. Turn the right-hand magneto by means of the driving flange on the left end of the shaft until the arrow in the rotor window (fig. 83) points to the terminal to which No. 1 red wire is attached. **NOTE:** A lobe of the breaker cam will be approaching the rubbing block on the breaker arm when the magneto is set in this position. Also note the arrow showing the direction of the breaker cam as shown in figure 83. Separate the breaker points in the right-hand magneto and place a narrow strip of cellophane between the points. Turn the magneto backward slightly to make sure the points are closed. Exert a slight pull on the cellophane with the fingers while the magneto is being turned slowly in direction of rotation. The cellophane will release the instant the points start to separate. The nut securing the left-hand driving flange (C, fig. 87) to the magneto drive shaft (H, fig. 87) must then be tightened while the magneto is setting in this position.

(4) **RECHECK TIMING OF THE RIGHT-HAND MAGNETO.** Again place a strip of cellophane between the points on the right-hand magneto. Turn the flywheel backward approximately one-quarter of a revolution, then turn it in direction of rotation until the cello-

IGNITION SYSTEM

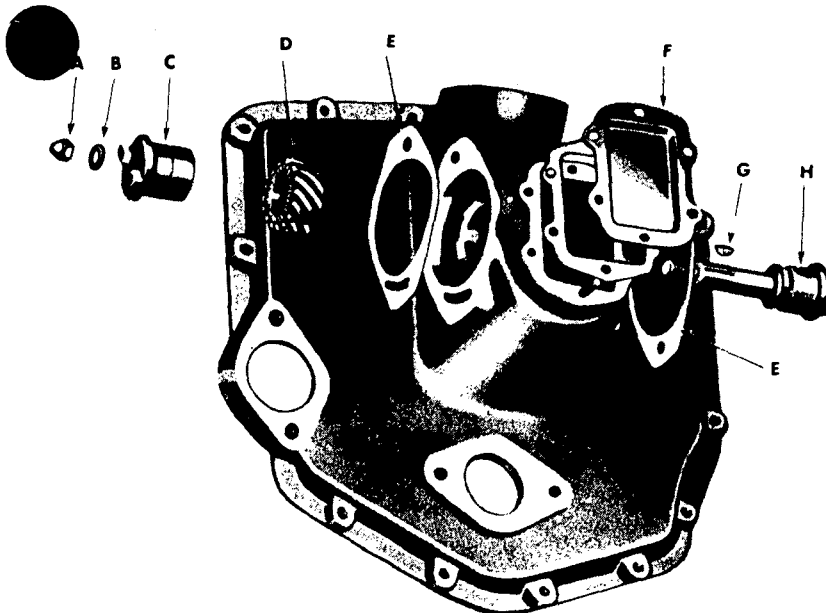

A—NUT
 B—WASHER
 C—MAGNETO DRIVE FLANGE
 D—MAGNETO DRIVE GEAR

E—GASKETS
 F—INSPECTION COVER
 G—KEY
 H—MAGNETO DRIVE SHAFT

RA PD 28183

Figure 87—Magneto Driven Gear and Magneto Drive Shaft Disassembled

phane releases by a slight pull on the cellophane with the fingers. The reason for turning the engine backward before bringing it up to the timing mark is to compensate for the backlash in the magneto drive mechanism. Note whether the timing mark on the flywheel is opposite the pointer. If a minor correction is necessary, tilt the magneto forward or backward, whichever is required. Tilting the magneto toward the front of the engine advances the spark, tilting it toward the rear of the engine retards the spark. In case a major correction is to be made, it will be necessary to again loosen the nut securing the left-hand driving flange (C, fig. 87) to permit moving the shaft forward or backward. Tighten the nut, and recheck the timing. **NOTE:** *One serration on the flange and the driven gear is equal to 5 degrees at the flywheel.*

(5) **INSTALL LEFT-HAND MAGNETO AND SET TIMING.** Turn the flywheel in the direction of rotation 300 degrees ($\frac{5}{6}$ of a turn) until the "SPARK SETTING L.H." mark appears opposite the pointer. Turn the magneto until the arrow in the rotor window

TANK, MEDIUM, M4A3

(fig. 83) points to the terminal to which No. 1 red wire is attached.

NOTE: A lobe of the breaker cam will be approaching the rubbing block on the breaker arm when the magneto is set in this position. Also note the arrow showing the direction of the breaker cam as shown in figure 83. Install the magneto (par. 66) and tilt the magneto so that the mounting studs are approximately midway in the slots of the magneto mounting flange. Separate the breaker points in the left-hand magneto and place a narrow strip of cellophane between the points. Turn the flywheel backward approximately one-quarter revolution, then turn in direction of rotation until the cellophane releases with a slight pull on the cellophane with the fingers and note whether the timing mark on the flywheel is at the pointer. The reason for turning the engine backward before bringing it up to the timing mark is to compensate for the backlash in the magneto drive mechanism. Any correction in the timing for the left-hand magneto can be made by tilting the magneto forward or backward. *NOTE: After the timing is set, clean the breaker point to remove any dirt, corrosion, or fragments of the cellophane which may have scuffed while the opening of the points was being checked.*

(6) **LOCK MAGNETOS IN PLACE.** After both magnetos have been properly set in the mounting slots and the correct timing established, tighten the mounting nuts and lock with wire. Install the magneto drive gear inspection cover and gasket (G104-15-93807).

68. SPARK PLUGS.

a. **Description.** The spark plugs used are the aircraft-type, Champion C88-S, and are radio shielded. The spark gap between the electrodes of the spark plug when new should be 0.011 inch to 0.014 inch. Do not attempt to adjust the spark gap. Replace the plugs when the gap increases to 0.030 inch.

b. **Replacement.** To remove the spark plugs (G104-17-40555), remove the cover plates over the spark plug compartment. Remove the retainer nuts with the wrench (41-W-3336-300) (fig. 88) and lift the wires from the spark plugs. Remove the spark plugs with the wrench (41-W-3336-300) (fig. 88). Check the gap of each spark plug with a round gage to make sure the spark gap is within the limits outlined above. To install the spark plugs, insert the plugs with gaskets (G104-15-93805) in the spark plug holes, and tighten each spark plug moderately (25 to 30 foot-pounds) with the wrench (41-W-3336-300) (fig. 88). The threads on the outside of the inserts and the inside of the cylinder head are left-hand threads, whereas the spark plugs have right-hand threads. Excessive tightening of the spark plug would screw the insert out of the head if it were not doweled to the head. However, the dowel being of a small diameter

IGNITION SYSTEM

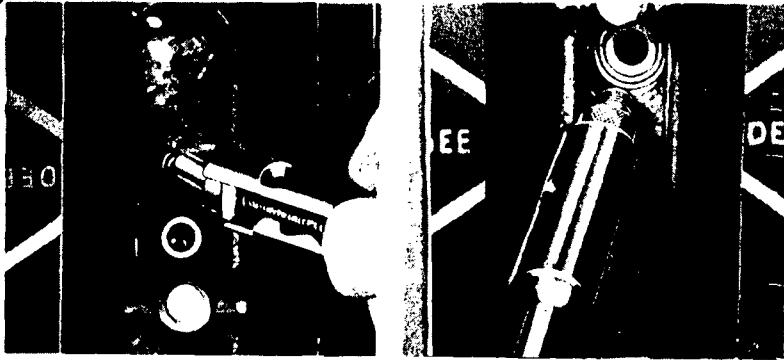

A—REMOVING SPARK PLUG TERMINAL NUT, USING WRENCH (41-W-3336-300)

B—REMOVING SPARK PLUG, USING WRENCH (41-W-3336-300)

RA PD 341207

Figure 88—Removing Spark Plug Terminal Nut and Spark Plug

and the insert and cylinder head made of relatively soft material, the threads are susceptible to damage from improper installation of the plug. Insert the spark plug wire terminals (G170-03-98804) in the spark plugs and tighten the spark plug wire retainers moderately with the special wrench (41-W-3336-300) (fig. 88).

69. SPARK PLUG WIRES AND CONDUITS.

a. **General** (fig. 33). The wires leading from the magneto to the spark plugs may be identified for both the right and left-hand magneto by colors marked on the wires as follows: No. 1—red; No. 2—blue; No. 3—green; and No. 4—yellow. Spark plug wires having cracked or damaged insulation must be replaced, as such wires may cause misfiring. If the flexible ignition conduit becomes damaged or frayed, it also must be replaced to avoid chafing of the spark plug wires.

b. **Spark Plug Wire Removal.** To remove one or more spark plug wires, remove the spark plug cover plates. Remove the circular plate covering the spark plug wire terminals on the magneto (fig. 83). Remove the fitting and retainer nut from the spark plugs of the wires to be changed (par. 68 b), and disconnect the terminals at the other end of the wires from the magneto. Attach a strong cord to the terminal at the magneto end of the wire, and pull the wire out of the conduit. Leave the cord in the conduit, as it is used later to pull a new wire through the conduit.

c. **Spark Plug Wire Installation.** Attach the cord described in paragraph b above, and pull a new wire through the conduit. At-

TANK, MEDIUM, M4A3

tach the spark plug retainer nut and fitting to the end of the wire and install the wire to the spark plug. Attach the other end of the wire to the proper terminal on the magneto (fig. 83).

d. **Flexible Conduit Replacement.** To remove the flexible conduit, unscrew the knurled nut at each end. Disconnect the spark plug wires from the magneto, and slip conduit from the wires. Install the flexible conduit, using new gaskets at each end of the flexible conduit, and attach the spark plug wires to the correct terminals in the magneto (fig. 83).

70. IGNITION SWITCH.

a. The operation of the ignition switch is described in paragraph 15 e. The ignition switch (G109-05-04369) can be removed after the instrument panel has been disassembled as outlined in paragraphs 90 b or 91 b.

Section XVII**FUEL, AIR INTAKE AND EXHAUST SYSTEMS****71. DESCRIPTION.**

a. The fuel and air intake system consists of two carburetors equipped with degassers, two air cleaners, a fuel pump, four fuel tanks with fuel supply lines, two fuel filters, one on some vehicles) and a priming pump with supply lines to the intake manifolds. The total capacity of the fuel tanks is approximately 175 gallons. The exhaust system consists of two exhaust pipes, one attached to each manifold on the engine and running through the rear wall of the engine compartment, and two external pipes bolted to the rear wall of the engine compartment.

72. CARBURETORS.

a. **Description** (fig. 89). Two Stromberg Model NA-Y5G carburetors (G104-15-31735) are used, mounted on carburetor adapters connecting the two intake manifolds at each end. The carburetors are dual (double-barrel) downdraft type. Each carburetor has two floats connected by one lever and operating on one needle valve. A separate main metering and idling system is provided for each barrel. Each barrel is equipped with a degasser (par. 73). An accelerating pump, which operates with the throttle, provides an extra quantity of fuel for rapid acceleration. The throttle linkage is arranged so that the forward carburetor remains closed until the rear carburetor is approximately half open (par. 77).

b. **Idle Fuel Adjustment** (fig. 89). Two idle fuel adjustment screws are provided on each carburetor, one for each barrel.

FUEL, AIR INTAKE AND EXHAUST SYSTEMS

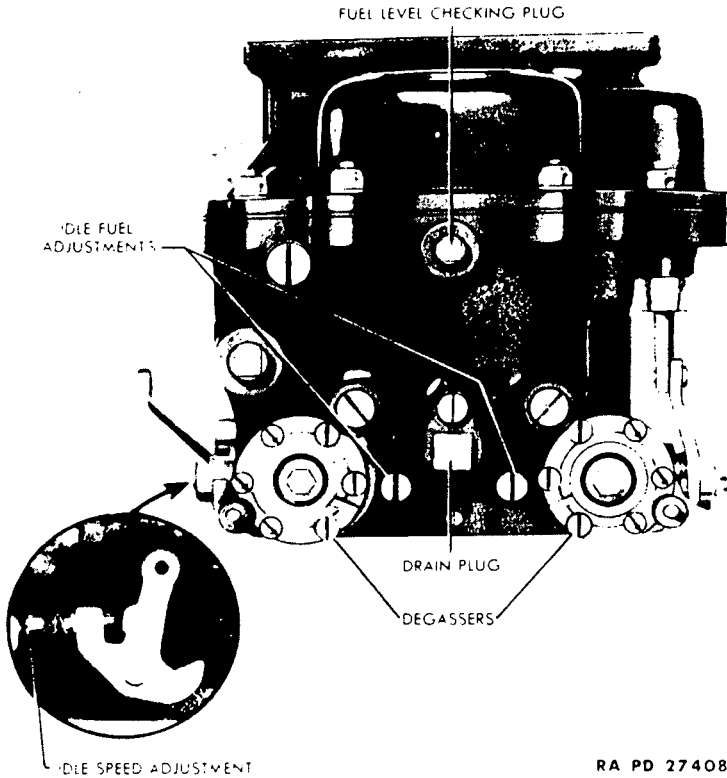

RA PD 27408

Figure 89—Carburetor

idle fuel adjustments on these carburetors are extremely uniform, and can be adjusted when either cold or hot. Make the idle fuel adjustments with the engine stopped. Turn each idle fuel adjusting screw in (clockwise) until it seats lightly, then turn it out one-quarter turn from the closed position. A stub (short) screwdriver will be required for making this adjustment on the forward carburetor.

c. Idle Speed Adjustment (fig. 89).

(1) **WET STOWAGE AND 105-MM HOWITZER VEHICLES.** Start the engine and run it until it reaches normal operating temperature. Disconnect the high idle link at the clutch cross shaft. Back off the idle speed adjustment at each carburetor until the engine idle speed is below 375 revolutions per minute. Set the idle speed adjustment at one of the carburetors until the engine idle speed is 375 revolutions per minute. Set the idle speed adjustment at the other carburetor until the engine speed just starts to increase, then

TANK, MEDIUM, M14A3

back off the adjustment slightly. Reconnect the high idle link to the clutch cross shaft, and adjust the link length until the engine idles at 800 revolutions per minute with the clutch pedal in the fully returned position.

(2) 75-MM DRY STOWAGE VEHICLES. Start the engine and run until it reaches normal operating temperature. Then set idling speed to 500 revolutions per minute by means of adjusting screw (fig. 89).

d. **Fuel Level Check.** Each carburetor is provided with fuel level checking plugs (fig. 89), one at the front of the carburetor, and one at the rear. To check the fuel level, remove the lock wire and the plug from the inspection hole in the front side of the rear carburetor, or the rear side of the forward carburetor. Start the engine and run it at idling speed. The fuel should be visible at the bottom of the threads of the inspection hole. If fuel is not visible, the fuel level is too low. If the fuel runs out of the inspection hole, the level is too high. In either case the carburetor should be replaced (subpars. e and f below).

e. **Removal (Either Carburetor).** Open the engine compartment doors. Loosen the clamps at the two carburetor air intake manifold tubes and remove the tubes from the manifold. Remove the nuts at the top of each carburetor which attach the carburetor air intake manifold to the carburetors. Remove the manifold. Disconnect the carburetor fuel feed line at the fuel pump. Disconnect the degasser electrical connections on the carburetor. Disconnect the throttle rod from the ball joint at the carburetor. Disconnect the carburetor control spring (G104-17-89655) (fig. 92). Remove the four carburetors base nuts holding the carburetor to the adapter and remove the carburetor and gasket. Remove the fuel line from the carburetor.

f. **Installation (Either Carburetor).** Place a new gasket (A-296609-A) and carburetor on the adapter studs. Install the four nuts to secure the carburetor to the adapter. Connect the degasser wires. Connect the carburetor fuel line to the carburetor and the fuel pump. Connect the throttle rod to the ball joint (G104-21-15852) on the carburetor. Place the air intake manifold on the carburetors, with the short end to the front carburetor (fig. 90), and install the nuts. *NOTE: On air intake manifolds without elbows for the air intake hose, the air intake manifold can be installed on the carburetor in a reversed position with the result that the air cleaner hose will be too short, even though it may be possible to install them. With the air cleaner hose too short, the flexing of the engine on its mounts will cause the hose to become disconnected, thereby losing the benefits of the air cleaner.* Place the two air cleaner hoses over the manifold connections, and tighten the clamps. Close engine compartment doors and install the cap screws.

FUEL, AIR INTAKE AND EXHAUST SYSTEMS

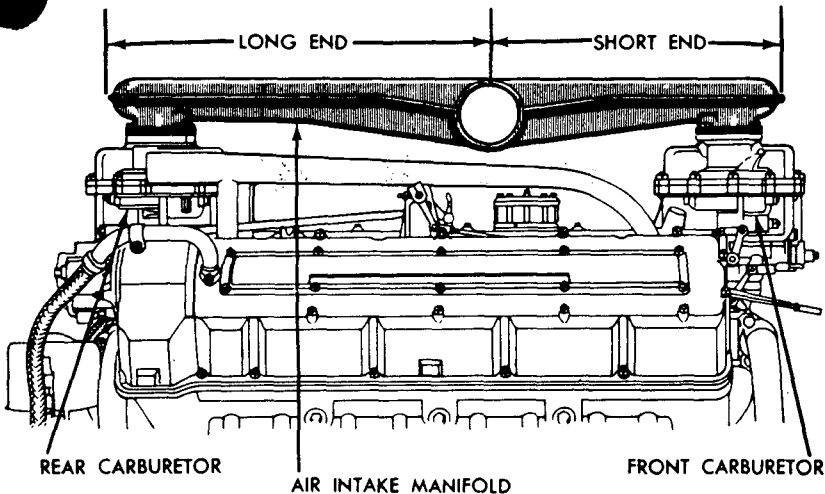

RA PD 329457

Figure 90—Air Intake Manifold Installation**73. DEGASSERS (fig. 89).**

a. **Description.** Each barrel of both carburetors is equipped with a vacuum-operated degasser with an electrical control for positive shut-off of the idle fuel mixture when stopping the engine. All fuel flowing through the idle discharge holes passes through the degasser needle valve seat. The purpose of the degasser is to shut off the idle fuel supply when high manifold vacuum is present during deceleration, to prevent flame and backfire through the exhaust. The electric fuel cut-off portion of the degasser works independently of the vacuum-operated portion, although it is in the same assembly, and operates the same needle valve. A solenoid built into each degasser closes the needle valve when the fuel cut-off button on the instrument panel is pressed. The purpose of the fuel cut-off is to shut off the idle fuel mixture just before stopping the engine, to prevent the fuel from reaching the cylinders, and to prevent the engine from continuing to run on preignition after the ignition switch has been turned off.

b. **Replacement.** To remove the degasser, open the engine compartment doors. Remove the two screws from the conduit shield cap and remove the cap. Pull the degasser wire out of its terminal socket. Remove the lock wire and the three screws which hold the degasser to the carburetor, and remove the degasser. To install the degasser, place it in position on the carburetor, and install the three screws to secure it to the carburetor. Install the lock wire in the screw. Con-

TANK, MEDIUM, M4A3

nect the degasser wire and install the conduit shield cap. Close engine compartment doors and install the cap screws.

74. CARBURETOR ADAPTERS.

a. **Description** (fig. 64). A carburetor adapter is connected to each end of the intake manifolds. These adapters are also connected to the exhaust manifolds by heater pipes which provide heat for the fuel air mixture as it comes from the carburetors. These adapters each contain two throttle plates operated by the engine speed governor.

b. **Replacement.** Open the engine compartment doors. Remove the heater pipe (fig. 64). Remove the carburetor (par. 72 e). Disconnect the clevis at the end of the governor throttle rod. When removing the rear adapter, disconnect the ball joint at the governor arm. Remove the six nuts which hold the adapter to the manifold. Remove the adapter. To install the carburetor adapter, place it in position on the intake manifold studs, and install the six nuts to secure it to the manifold. Install the carburetor on the carburetor adapter as outlined in paragraph 72 f. When installing the rear adapter, connect the ball joint at the governor arm. Connect the clevis at the end of the governor throttle rod.

75. GOVERNOR.

a. **Description.** The speed of the engine is regulated and limited by the use of additional dual throttle plates, located in each of the carburetor adapters directly under each carburetor. These carburetor adapter throttle plates are connected by a rod, which in turn is connected to the governor located at the rear of the right-hand camshaft housing and is driven by the right-hand intake camshaft. With the engine idling, these governor-actuated throttles are in the wide-open position. As the engine speed is increased, the action of the governor partially closes the throttles, thus limiting the maximum engine speed to approximately 2,600 revolutions per minute under full load. All maintenance on the governor must be referred to ordnance maintenance personnel.

b. **Link Adjustment.** The governor throttle connecting link should be adjusted by means of the clevis on the forward end so that with the engine stopped, both throttle levers are against the stop on both carburetor adapters (fig. 92).

c. **Removal.** Remove the cotter pin from the governor link at the governor. Loosen the governor link lock screw and disconnect the link from the governor. Remove the six nuts that hold the governor to the accessory cover and remove the governor.

FUEL, AIR INTAKE AND EXHAUST SYSTEMS

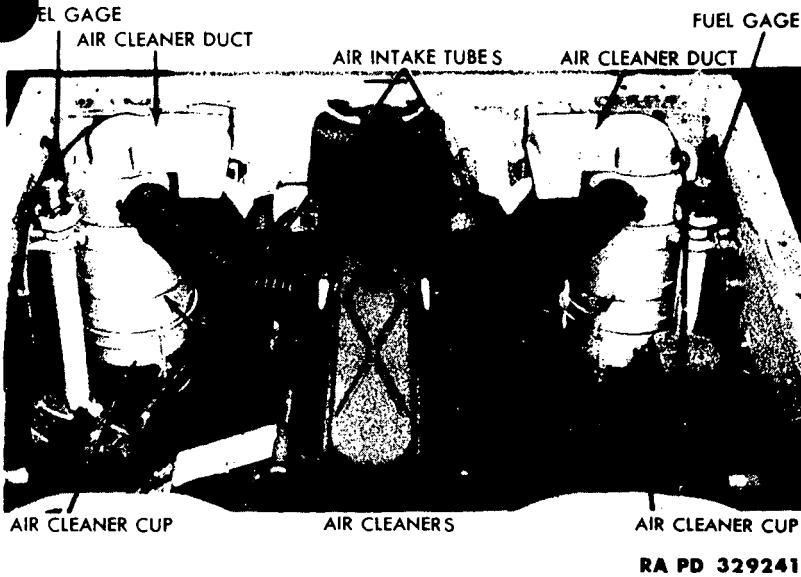

Figure 91—Air Cleaners

d. **Installation.** Install a new gasket on the governor. Hold the governor in place on the camshaft cover and install the six nuts. Connect the governor link to the governor arm and tighten the governor link lock screw, then back off the screw one-half turn. Install a cotter pin in the governor link. Adjust the governor throttle connecting link as outlined in subparagraph b above.

76. AIR CLEANERS.

a. **Description** (figs. 9 and 91). Two air cleaners of the oil-bath type, mounted on the bulkhead, are either located in the engine compartment or in the fighting compartment. If the air cleaners are located in the engine compartment, an air cleaner duct assembly is provided for each air cleaner. These ducts lead into the fighting compartment (fig. 77). A control handle is located at each duct opening into the fighting compartment. When the handle is pushed in, the air is drawn into the air cleaner from the fighting compartment. When the handle is pulled out, the air is drawn from the engine compartment. Two air cleaner inspection doors, located in the fighting compartment at either side of the bulkhead (fig. 10), are provided for the servicing of the air cleaner. If the air cleaners are installed in the fighting compartment, air ducts or inspection doors are not necessary.

TANK, MEDIUM, M4A3

b. Replacement.

(1) **AIR CLEANERS EQUIPPED WITH AIR DUCTS.** Remove the six cap screws which secure the air duct to the top of the air cleaner, and remove the duct. Loosen the clamps at each end of the carburetor intake to air cleaner tube, and remove the tube. Remove the four cap screws which hold the mounting band, and remove the cleaner. To install the air cleaner, place it in position on the bracket. Place the mounting band in position, and secure it to the bracket with four cap screws. Install the air intake tube on the carburetor air intake manifold and the air cleaner connections. Place the air duct on the top of the air cleaner, and in the opening in the bulkhead, and secure it to the cleaner with six cap screws.

(2) **AIR CLEANERS WITHOUT AIR DUCTS.** Turn the turret until the door in the turret exposes the air cleaner. Disconnect the air cleaner tube. Loosen the three wing nuts that secure the cup to the cleaner and remove the cup. Remove the four mounting bracket cap screws and remove the air cleaner. To install the air cleaner, secure the air cleaner and bracket to the bulkhead with four cap screws. Install the cup on the air cleaner and tighten the three wing nuts.

77. THROTTLE CONTROLS.

a. **General.** The carburetor throttle control linkage, as shown in figure 92, is arranged so that the throttle plates of the rear carburetor open to approximately half-throttle before the forward carburetor throttle plates start to open. The rate of opening of the throttle plates in the forward carburetor is approximately twice as fast as for the rear carburetor, with the result that both reach the wide-open point together.

b. **Adjustment** (fig. 92). Screw the ball and socket joint onto each throttle control rod until a length of $16\frac{5}{8}$ inches, measured from the center of the ball to the center of the pin hole at the other end of the rod, is obtained. Adjust the length of the rod connecting the lever at the center bracket to the cross shaft on the bulkhead to attain a length of 22 inches, measuring it from the end of one ball joint to the end of the ball joint at the other end of the rod. After all control rods are connected, adjust the stop on the inner end of the center bracket cross shaft so that the rear carburetor will start to open with a slight movement of the throttle rod.

c. Hand Throttle.

(1) **DESCRIPTION.** The hand throttle mounted on the final drive housing is connected to the carburetor control through rods and two cross shafts. One cross shaft is located at the rear of the driver's seat, and one on the front side of the bulkhead. The rear of the thro

FUEL, AIR INTAKE AND EXHAUST SYSTEMS

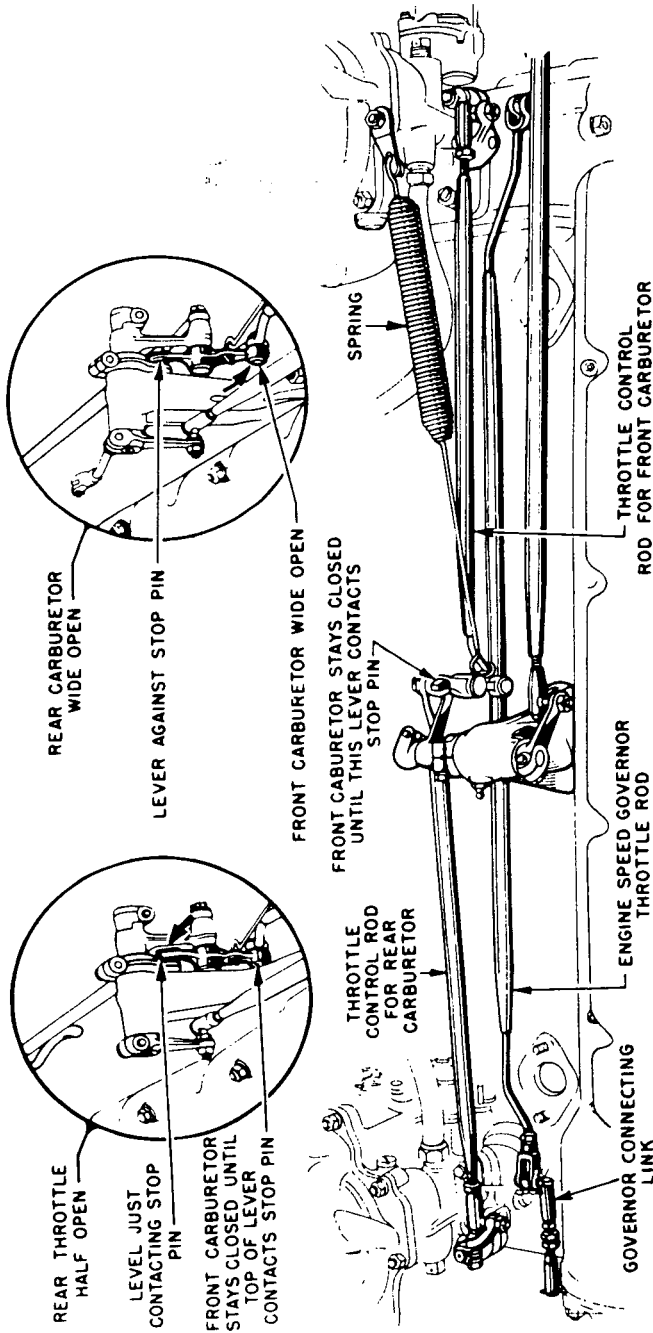

RA PD 28307

Figure 92—Throttle Linkage

TANK, MEDIUM, M4A3

cable is connected to the foot throttle through a slip connect which allows either the foot or hand throttle to be operated independently of the other.

(2) **REMOVAL.** Loosen the lock nut at the bottom of the hand throttle bracket, and remove the cable and conduit from the bracket. Remove the four bolts which hold driver's seat bracket to the floor plate. Remove the seat. Remove the screws from the driver's compartment floor plate and remove the plate. Loosen the two bolts which hold the cover over the throttle linkage at the throttle cross shaft, and remove the cover. Remove the nut from the hand throttle conduit where it is attached to the hull floor. Remove the clevis pin from the clevis at the rear end of the throttle rod, and remove the conduit, cable, and rod.

(3) **INSTALLATION.** Place the conduit, cable, and rod in position on the hull floor, and secure it with a nut. Adjust the clevis on the hand throttle rod so that there is $\frac{1}{8}$ -inch free movement in the throttle button. Install the clevis pin to connect the clevis to the cross shaft lever. Place the floor plate in position, and secure it to the floor with screws. Place the cover over the throttle linkage at the cross shaft, and secure it with two bolts. Place the driver's seat in position, and secure it to the floor plate with four bolts. Place the cable and conduit through the hand throttle bracket, and secure it with the lock nut.

(4) **ADJUSTMENT.** Loosen the two bolts which hold the cover over the throttle linkage at the throttle cross shaft, and remove the cover. Remove the clevis pin from the hand brake clevis on the rear of the hand brake rod and adjust the clevis so that the throttle button has approximately $\frac{1}{8}$ -inch free movement. Install clevis pin in brake rod clevis.

d. Foot Throttle.

(1) **DESCRIPTION.** The foot throttle pedal is connected to the carburetor control through the same rods and two cross shafts which are used by the hand throttle.

(2) **REMOVAL.** Remove the screws from the front section of the driver's compartment floor plate, and remove the plate. Remove the clevis pin and the retracting spring from the clevis connecting the pedal to the throttle rod. Remove the lock wire and bolt from the bracket at the base of the throttle pedal, and remove the pedal.

(3) **INSTALLATION.** To install the foot throttle pedal, place it in position, and install the bolt in the bracket at the base of the pedal. Secure the bolt with lock wire. Connect the retracting spring to the foot pedal. Install the clevis pin in the clevis and foot pedal.

FUEL, AIR INTAKE AND EXHAUST SYSTEMS

connect the foot throttle pedal to the throttle rod. Install the nuts in the front section of the floor plate to secure it to the hull floor. Adjust the linkage as outlined in paragraph 77.

e. **Governor Throttle Control.** The operation of the governor, which controls and limits the engine speed through additional throttles in the carburetor adapters, is described in paragraph 74 a. Adjustment of governor throttle connecting link is outlined in paragraph 75 b.

78. PRIMING PUMP.

a. **Description.** The use and operation of the priming pump, located on the front bow or on the instrument panel in the driver's compartment, is described in paragraph 13 f.

b. **Replacement.** If the priming pump is mounted on the instrument panel, the instrument panel must be disassembled (pars. 90 b or 91 b) before the priming pump can be removed. Disconnect the inlet and outlet fuel lines at the priming pump. Remove the knob from the priming pump, and remove the large packing nut. Remove the lock nut which secures the priming pump to the bracket, and remove the pump. To install the pump, place it in position on the bracket, and install the lock nut. Install the packing nut and knob. Connect the inlet and outlet fuel lines to the priming pump.

FUEL PUMP.

a. **Description.** The fuel pump is of the conventional diaphragm type, and is mounted on the left-hand camshaft cover. The pump is driven by the left intake camshaft. The pump maintains from 4½ to 6 pounds fuel pressure to the carburetors.

b. **Replacement.** Close all of the fuel shut-off valves. Disconnect the fuel inlet line connection at the pump. Disconnect the outlet fuel line (A-381632-A) at the pump. Remove the two nuts and washers which secure the pump to the camshaft cover and remove the fuel pump (G104-17-45835). To install the fuel pump, place it in position on the camshaft cover with a new gasket (G104-15-93832) and install the two flat washers and nuts. Connect the inlet and outlet fuel line connections to the pump. Open the fuel shut-off valves.

80. FUEL FILTERS.

a. Main Tank.

(1) **DESCRIPTION** (figs. 93 and 94). Two different type fuel filters are used on M4A3 vehicles. One type is a disk-type filter incorporated in each vertical tank. This type of filter requires no

TANK, MEDIUM, M4A3

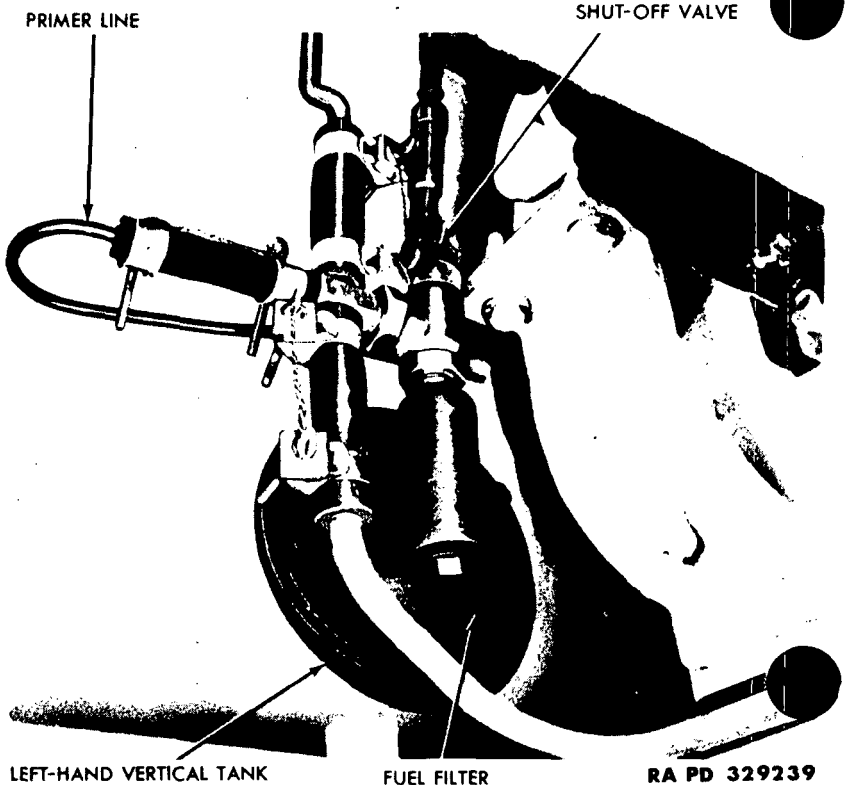

Figure 93—Fuel Filter Incorporated in Fuel Tank

servicing between engine overhaul periods, therefore, no drain is provided in this type of filter. The other type of fuel filter consists of a stack-type disk element and a metal filter bowl mounted on the left fire wall in the engine compartment. Inlet and outlet passages are marked "IN" and "OUT." The filtering element consists of a large number of filter disks (0.020 inch thick) stacked and squeezed together.

(2) **DRAINAGE.** To drain the metal bowl-type filter, close all fuel shut-off valves and remove the drain plug at the bottom of the metal bowl to remove accumulated dirt and water.

(3) **FILTER ELEMENT REMOVAL AND CLEANING** (fig. 94). Remove the center stud at the top of the filter. Clean the bowl and wash the filter element (AC-5570090) in dry-cleaning solvent. Care must be taken to prevent bending or distorting the disks. Do not scrape.

FUEL, AIR INTAKE AND EXHAUST SYSTEMS

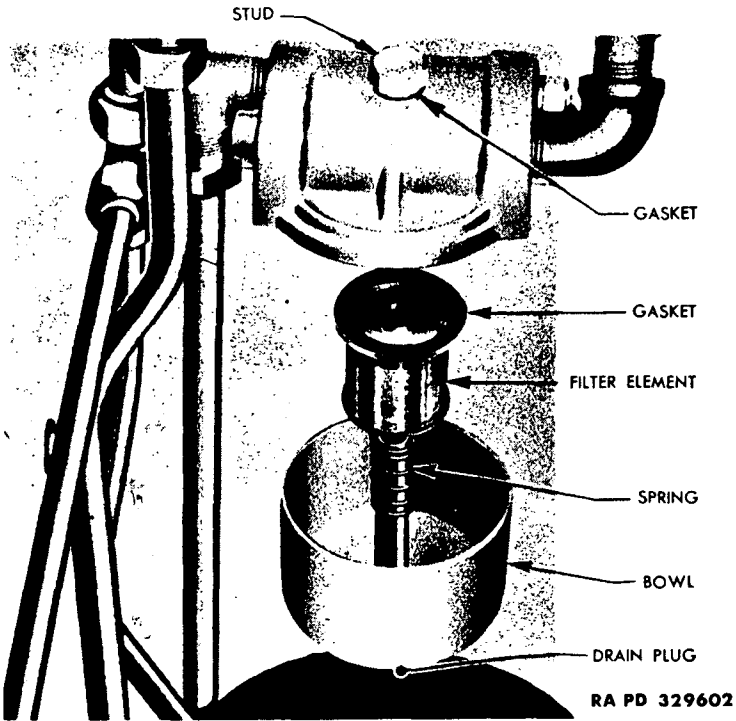

Figure 94—Fuel Filter Mounted on Fire Wall

scrub, or attempt to disassemble the filter element, replace the element if it cannot be cleaned satisfactorily. Insert the gasket and install the filter element and bowl. If the gasket is damaged, replace it.

b. Auxiliary Generator Fuel Tank (figs. 20 and 21).

(1) **DESCRIPTION.** A fuel filter of the glass bowl type is provided for the auxiliary generator. On some models two fuel shut-off valves are provided, one at the fuel tank and one at the filter. On other models the fuel filter is mounted to the fuel tank, and only one fuel shut-off valve is provided.

(2) **CLEANING.** To clean this filter, shut off the fuel valve at the fuel tank. Unscrew the nut at the bottom of the bowl. Move the bail wire to one side and remove the bowl. Clean the bowl and reinstall it.

TANK, MEDIUM, M4A3

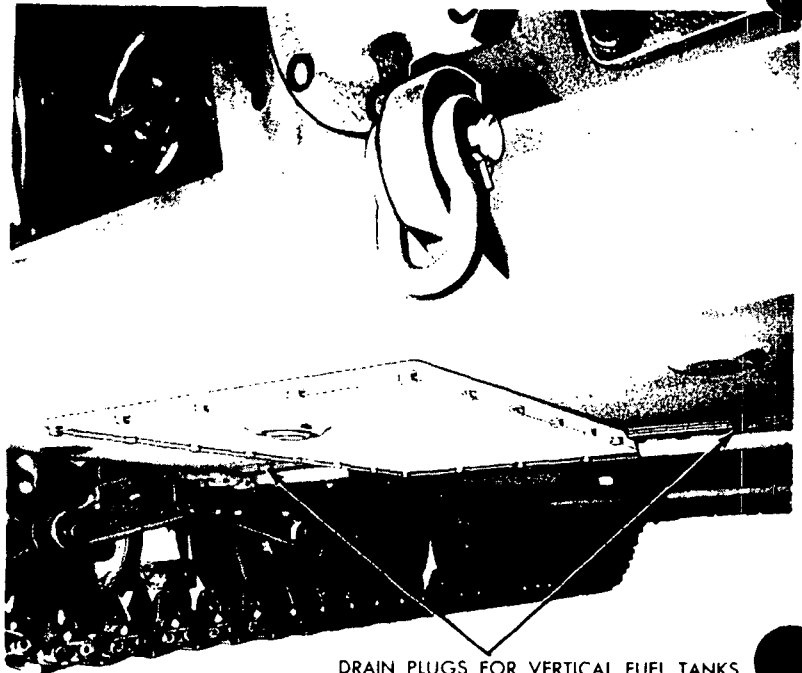

DRAIN PLUGS FOR VERTICAL FUEL TANKS

RA PD 329234

Figure 95—Drain Plugs for Vertical Fuel Tanks (75-mm Dry Stowage and All Main Tanks, 75-mm Wet Stowage, 76-mm, and 105-mm Howitzer Vehicles)

81. FUEL TANKS.

a. **Description** (figs. 40 and 41). Four fuel tanks are provided, two vertical and two horizontal. The tanks are located in the engine compartment and are enclosed by means of a steel fire wall. The total fuel capacity is 168 gallons. On some vehicles two fuel shut-off valves are provided, one for each vertical tank; on other models a fuel shut-off valve is provided for each of the four tanks. Vehicles that are equipped with four fuel shut-off valves have a drain plug in each of the four tanks (figs. 95 and 96). Vehicles having only two fuel shut-off valves have a drain plug in each vertical tank only (fig. 95).

b. Drainage.

(1) **DRAIN HORIZONTAL TANKS.** Remove two screws from the round plate on the bottom of the sponson shelf (fig. 96) and loosen the third screw. Swing the round plate out of the way as shown in figure 96. Take out the drain plug, using $\frac{3}{16}$ -inch socket head screw wrench.

FUEL, AIR INTAKE AND EXHAUST SYSTEMS

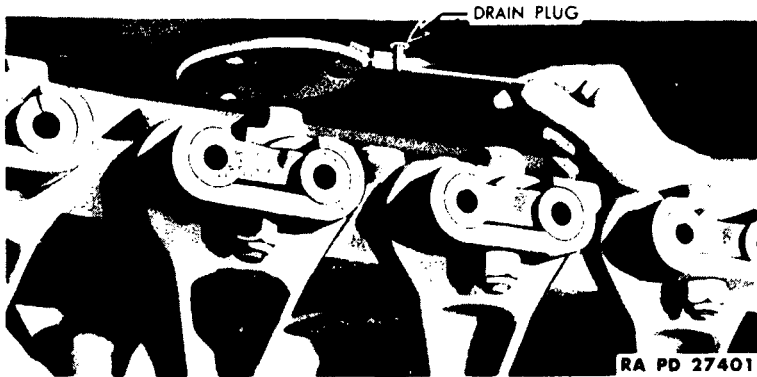

Figure 96—Drain Plug for Horizontal Tank (75-mm Dry Stowage Vehicles)

(2) **DRAIN VERTICAL TANKS.** Remove plug in bottom of engine compartment floor opposite center of rear bogie wheel assembly, right and left (fig. 95), using a socket head set screw 1-inch wrench. Remove tank plugs, using $\frac{5}{16}$ -inch socket head set screw wrench.

c. Either Horizontal Tank Replacement (75-mm Dry Stowage).

(1) **REMOVAL.** Remove vertical fuel tank as outlined in subparagraph e below. Drain the tank as outlined in subparagraph h (1) above. Remove auxiliary generator muffler and tail pipe. This applies to removal of left tank only. Disconnect the outlet fuel hose at the fuel pump. Remove fuel hose from the fuel filter. Remove the two cap screws securing the fuel filter. Remove the fuel filter inlet connection and remove the filter. Disconnect fire extinguisher pipe and nozzle from engine compartment side wall and remove discharge nozzles from their brackets. Disconnect the fuel line. Remove the fan shroud (par. 86 d). Remove the upper half of the vertical fuel tank wall. Take out the 12 cap screws and remove one nut which secures the wall to the hull on each side. Remove the upper half of the horizontal fuel tank wall. Take out the four cap screws and remove the four nuts which secure the wall to the hull on each side. Remove nut and bolt from the fuel tank. Remove the fuel tank filler cap. Remove the fuel level gage wire after tank is pulled part way out. Lift the tank from the vehicle.

(2) **INSTALLATION.** Place the fuel tank about halfway on the sponson and connect the fuel gage wire to the fuel gage unit. Place the fuel tank in position on the sponson and install the nut and bolt

TANK, MEDIUM, M4A3

in each of the two fuel tank hold-down straps. Install the filler cap. Hold the upper half of the fuel tank fire wall in position and install the four nuts and cap screws. Hold the upper half of the vertical fuel tank fire wall in position and install the 12 cap screws and nuts which secure the wall to the hull. Install the fan shroud (par. 86 d). Connect the fuel line to the fuel tank. Install the fire extinguisher nozzles. Install the fuel filter and connect the fuel lines to the filter and fuel pump. Install the auxiliary generator tail pipe and muffler (par. 160 b (1) (b)). Install the vertical fuel tank as outlined in subparagraph e (2) below.

d. Horizontal Fuel Tank Replacement (Wet Stowage and 105-mm Howitzer).

(1) **REMOVAL.** Remove the engine as outlined in paragraph 63. Drain the fuel tanks as outlined in subparagraph b (2) above. Remove the air cleaners (par. 76 b (1)). Disconnect the wire from the fuel gage unit on the vertical fuel tank filler pipe. Remove the two cap screws that hold the fuel gage wire conduit to the fire wall and lay the conduit to one side. Unscrew the filler neck from the vertical fuel tank. Loosen the clamps and remove the flexible fuel line that connects the vertical and horizontal fuel tanks. Remove the six cap screws from the vertical fuel tank cover and remove the cover. Remove the two cap screws that secure the electrical conduit to the fire wall. Disconnect the taillight wires at the connector plug and lay the conduit to one side. Remove the fan shroud (par. 86 d). Remove the cap screws that hold the horizontal fire wall to the hull and remove the wall. Remove the nine screws from the horizontal fuel tank filler neck grommet retainer and remove the retainer and gaskets. Remove the six screws from the filler neck and remove the filler neck. Remove the bolt from each hold-down strap and remove the fuel tank.

(2) **INSTALLATION.** Place the fuel tank in position on the sponson and install a bolt in each hold-down strap. Place the filler pipe gasket on the fuel tank with the wide side of the gasket in line with the wide side of the fuel tank flange. Place the filler pipe on the fuel tank in position so that the top of the filler pipe will be at the same angle as the hull plate. Install the six filler pipe screws. Place the inner (threaded) grommets on the retainer on the filler pipe. Place the inner and outer grommets on the filler pipe making sure the holes in the grommets and retainer are in line. Install the outer retainer and nine cap screws. Install the fan shroud (par. 86 d). Hold the fire wall in position and install the cap screws to secure it to the hull. Connect the taillight wires at the plug unit above the fuel tank. Install the vertical fuel tank cover and cap screws. Install the flexible fuel line that connects the vertical and horizontal fuel tanks. Install

FUEL, AIR INTAKE AND EXHAUST SYSTEMS

1. Tighten the filler neck in the vertical fuel tank. Secure the fuel gage wire conduit to the fire wall with two cap screws. Connect the fuel gage wire to the fuel gage unit. Install the air cleaners (par. 76 b (1)). Install the engine (par. 64).

e. Either Vertical Fuel Tank Replacement (75-mm Dry Stowage).

(1) **REMOVAL.** Open the engine compartment doors. Remove the engine compartment front plate. Drain vertical fuel tank as outlined in subparagraph b (2) above. Remove the engine compartment floor plate. Disconnect the outlet pipe connection at the bottom of the tank and unscrew the pipe fitting from the vertical fuel tank. Remove the cap screws from the upper half of the vertical fuel tank fire wall and remove the wall. Loosen the set screws on the fuel tank hold-down bracket at the top of the fuel tank. Remove the three cap screws and guide bracket from the side of the vertical tank. Remove air cleaner assembly (par. 76 b (2)). Remove the fire extinguisher fittings, if removing left-hand vertical tank. Remove the three cap screws which hold the hold-down bracket to the bulkhead and remove the bracket. Lift the fuel tank from the vehicle.

(2) **INSTALLATION.** Lower the fuel tank into position in the vehicle. Connect the fuel line to the fuel tank. Install the guide bracket at the side of the fuel tank with three cap screws. Secure the hold-down bracket to the bulkhead with three cap screws. Install the fire extinguisher fittings if they were removed. Place the hold-down bar in position on the tank and tighten and lock the set screws. Hold the upper half of the fire wall in position and install the cap screws. Install the air cleaners. Install the engine compartment front plate. Close the engine compartment doors.

f. Vertical Fuel Tank Replacement (Wet Stowage and 105-mm Howitzer).

(1) **REMOVAL.** Drain the fuel tanks as outlined in subparagraph b (2) above. Open the engine compartment doors. Remove the engine compartment front plate. Remove the air cleaner. Disconnect the fuel gage wire. Remove the gage clamp and unscrew the fuel gage and tube from the tank. Remove the cap screws from the vertical fuel tank cover and remove the cover. Remove the flexible line that connects the horizontal and vertical fuel tanks. Disconnect the fuel line and fuel shut-off linkage from the fuel filter. Remove the cap screws that secure the filter to the tank and remove the filter. Remove the cap screws that secure the vertical fuel tank fire wall to the hull and remove the fire wall. Lift the tank from the vehicle.

TANK, MEDIUM, M4A3

(2) **INSTALLATION.** Position the fuel tank in the vehicle. Fit the fire wall in place and install the cap screws. Slide the four wooden bumpers in place between the fuel tank and hull. Install the fuel filter in the fuel tank, using a new gasket. Connect the fuel line and fuel shut-off control to the fuel filter. Install the vertical fuel tank cover on the fire wall and hull. Screw the fuel gage and tube into the vertical tank. Install the clamp on the tube. Connect the wire to the gage. Install the conduit hold-down clips. Install the engine compartment front plate. Close the engine compartment doors.

g. Auxiliary Generator Fuel Tank Replacement.

(1) **WET STOWAGE AND 105-MM HOWITZER VEHICLES.** Remove the auxiliary generator (par. 160). Remove the filler neck retainers and grommet. Drain the fuel tank. Remove the six cap screws that secure the fuel tank to the hull and remove the tank. To install the tank, hold it in place and install the six cap screws to secure it to the hull. Install the auxiliary generator (par. 160). Install the filler neck grommet and retainers.

(2) **75-MM DRY STOWAGE VEHICLES.** Remove the filler neck grommet and retainers. Turn the shut-off valve on the fuel filter to the "OFF" position and disconnect the fuel line at the filter. Remove the air cleaner (par. 76 b (2)). Remove the four cap screws that secure the fuel tank bracket to the hull and remove the bracket and fuel tank. To install the tank, hold it and the bracket in place and install the four cap screws in the bracket. Connect the fuel line to the filter. Install the air cleaner (par. 76 b (2)). Install the grommet and retainers on the filler neck.

82. EXHAUST PIPE REPLACEMENT.

a. Removal. To remove either the right or the left-hand exhaust pipe, remove the six bolts that secure the exhaust pipe to the exhaust manifold on the engine. Loosen the nut on the clamp bolt at the exhaust pipe at rear of engine compartment. Remove the exhaust pipe. Remove the five bolts from the external exhaust pipe on rear of hull, and remove the pipe.

b. Installation. To install the exhaust pipe, use new bolts, nuts, and gaskets and assemble the exhaust pipe to the exhaust manifold. Using new packing, install the five bolts securing the external exhaust pipe to the rear of the hull.

COOLING SYSTEM

eed and then fill the system completely. Stop the engine when the cooling system is completely full. Examine the entire cooling system for leaks. This is important because the cleaning solution uncovers leaks which already exist but are plugged with rust or corrosion. Leaks that cannot be corrected by using arm should be reported immediately to ordnance maintenance personnel.

i. Coolant Service.

(1) When servicing the vehicle for summer, fill the system nearly full with clean water. Add corrosion inhibitor compound in the proportion of one container of inhibitor to each 4 gallons of cooling system capacity. Then complete filling the system with water.

(2) When servicing for winter, fill the system about one-quarter full of clean water. Add sufficient compound, antifreeze (ethylene glycol type) for protection against the lowest anticipated temperature (par. 25). Add water until the system is nearly full, then run the engine until the normal operating temperature is reached. Then add sufficient water to fill the system to the proper level, as outlined in paragraph 83 d.

84. RADIATOR.

a. **Description.** The radiator is of the tube-and-fin cross-flow type, using flat horizontal tubes. The hot water flows through the tubes to which are attached thin vertical copper fins. Air forced between these fins by the fans carries the heat away, thus cooling the water.

b. Removal.

(1) **PRELIMINARY WORK.** Open the engine compartment doors. Remove the cap screws which secure the engine compartment rear cover plate to the hull, and lift the cover from the hull with a chain fall or hoist. Remove the four bolts which secure the radiator hold-down plate to the fan shrouds, and remove the plate. Remove the plug at the bottom of the water pump (fig. 78), and drain the cooling system. Loosen the hose clamps, and remove the radiator upper hose (A-244756) and radiator to water pump hose (A-244726-B).

(2) **REMOVE RADIATOR UPPER AND LOWER WATER CONNECTIONS.** Remove the four cap screws from the upper radiator connection and the four cap screws from the lower water connections, and remove the connections.

(3) **REMOVE UPPER AND LOWER RADIATOR BAFFLES, AND DISCONNECT VENT PIPES.** Remove one bolt on each end which holds the lower air baffle, and remove the baffle. **CAUTION:** *The air baffle can be rested on top of the engine compartment rear door to*

TANK, MEDIUM, M4A3

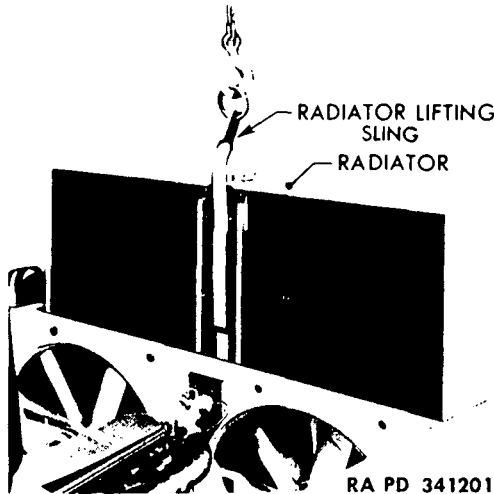

Figure 97—Removing Radiator With Lifting Sling (41-S-3832-86)

take some of the weight off the bolts; however, to remove the baffle requires two men, one at each end to hold baffle up as bolts are removed, so that it can be lowered gradually. Remove one bolt at each side of the upper radiator air baffle located at the top rear of the radiator, and remove through the opening below baffle. Disconnect the vent pipe, and remove the nipple from the radiator top tank on each side.

(4) **REMOVE RADIATOR** (fig. 97). Connect radiator lifting hook and carefully pull out the radiator, using a chain fall or hoist.

c. Installation.

(1) **PLACE RADIATOR IN POSITION.** Connect the lifting hook (fig. 97) to the radiator, and lower it carefully into place.

(2) **CONNECT VENT PIPES AND INSTALL UPPER AND LOWER RADIATOR BAFFLES.** Install the vent pipe nipple on each side of the radiator, and connect the radiator vent pipes, one to each nipple. Place the upper radiator baffle in position, and secure it to the hull with a bolt at each end. Place the lower radiator baffle in position, and secure it to the hull with a bolt at each end.

(3) **INSTALL RADIATOR UPPER AND LOWER WATER CONNECTIONS.** Place the lower water connection in position and, using a new gasket, secure it to the radiator with four cap screws. Connect the upper water connection (A-244758), using a new gasket (A-244722).

Section XVIII

COOLING SYSTEM

83. COOLING SYSTEM (fig. 44).

a. **General Description.** The engine is cooled by circulation of water through the water jackets which extend the full length of the cylinder bores. Water is pumped from the radiator through the engine and back into the radiator by means of a centrifugal water pump (par. 85).

b. **Cooling System Seal.** The entire cooling system is sealed by means of a pressure filler cap (B-197409) which remains cooled until a pressure of 12 pounds is reached. This results in raising the boiling point of the water, thus reducing loss of water or antifreeze. An expansion tank permits steam or antifreeze vapors to condense and return to the cooling system, further reducing the loss of water or antifreeze.

c. **Capacity.** The capacity of the entire cooling system is 14 gallons.

d. **Servicing.** Always use clear water, preferably rain or soft water, if possible. Do not put cold water into the system when the engine is hot. The radiator and cooling system should be drained, flushed, and refilled with clean water, and corrosion inhibitor should be added (par. 39) at each 1,000-mile inspection. A drain plug is provided at the bottom of the water pump (fig. 78). The expansion tank is provided with a drain plug (fig. 100). On the earlier model engines a drain plug is located on each side of the engine directly opposite the engine rear mounts. On the later engines the drain plugs are located approximately 6 inches ahead of the engine rear mounts. On the later model vehicles a petcock is provided in the radiator outlet housing (fig. 99) for checking the water level in the cooling system. **NOTE:** *Do not fill above this point.*

e. Cleaning.

(1) Run the engine until the temperature is within operating range. Stop the engine, remove the expansion tank cap, and drain the system by removing the drain plug (A-411672) in the bottom of water pump and the two drain plugs, one on each side of the cylinder block. If necessary, use a wire to keep open any drain hole which tends to become clogged.

(2) Allow the engine to cool. Install the drain plugs and pour water slowly into the expansion tank until the system is approximately half full, then run the engine at idling speed. Add the cleaning compound in the proportion of one container of cleaner to every 4 gallons of cooling system capacity. Then complete filling the system with water. *Never mix the water and the cleaning compound*

TANK, MEDIUM, M4A3

before putting them into the system. CAUTION: Do not spill solution on skin, clothing or painted portions of the vehicle.

(3) Replace the expansion tank cap and run the engine at fast idling speed until the coolant reaches a temperature above 180° F, but not over 200° F. Do not drive the vehicle. Constantly check the level in the cooling system.

(4) Stop the engine after it has run for 30 minutes, or until the temperature reaches at least 180° F, but not over 200° F. Then remove the expansion tank cap and the three drain plugs, and drain the system completely.

f. Neutralizing.

(1) Allow the engine to cool. Install the three plugs and pour water slowly into the expansion tank until the system is approximately half full, then run the engine at idling speed. Add the neutralizer compound in the proportion of one container of neutralizer to every 4 gallons of cooling system capacity. Then fill the system with water.

(2) Let the engine idle for at least 5 minutes at normal operating temperature. Then stop the engine.

(3) Drain the system completely by removing the expansion tank cap and removing the three drain plugs.

g. Flushing.

(1) Allow the engine to cool. Install the three drain plugs. Pour water slowly into the expansion tank until the system is approximately half full, then run the engine at idling speed and fill the system completely.

(2) Run the engine until the coolant is heated to the normal operating temperature.

(3) Drain the system by removing the expansion tank and removing the three drain plugs. Repeat the flushing operation until the drain water is clear.

(4) Again allow the engine to cool, and then clean all sediment from the expansion tank. Blow insects and dirt from radiator core air passages with compressed air, blowing from the front of the radiator. Use water if necessary to soften obstructions.

(5) Flush the expansion tank by filling it with water and then draining completely.

h. Leaks. After completing the flushing operation, make certain that the engine has been allowed to cool again. Install the three drain plugs. Pour water slowly into the expansion tank until the system is approximately half full, then run the engine at idling

COOLING SYSTEM

(4) **FINAL ASSEMBLY.** Install the radiator to water pump hose and the radiator upper hose, and tighten the clamps. Install the radiator hold-down plate with four bolts through the plate and fan shrouds. Place the engine compartment rear cover plate in position with a hoist, and secure it to the hull with cap screws. Install the drain plug in the bottom of the water pump, and fill the cooling system. Close the engine compartment doors. Close the rear door of engine compartment, and secure it with three cap screws.

85. WATER PUMP.

a. **Description** (fig. 78). The water pump (G104-17-45830) is of the centrifugal type, driven by a splined shaft from the rear of the crankshaft.

b. **Lubrication.** The water pump is lubricated from the engine, and as a permanent water seal is used, no attention is required.

c. **Removal.** Open the rear door of the engine compartment. Remove the plug at the bottom of the water pump (fig. 78), and drain the cooling system. Loosen the hose clamps, and remove the hose running from the radiator lower connection to the water pump. Remove the four nuts which hold the water pump to the crankcase, two at the center connection, and two at the water connection to the left, then remove the pump.

d. **Installation.** Using a new outlet gasket (A-296663-A) and a new inner gasket (A-296490), place the water pump in position over the four studs on the crankcase, and install the four nuts and washers. Install the two hose running from the water pump to the radiator lower connection, and tighten the clamps. Install the drain plug in the bottom of the water pump, and fill the cooling system. Close the rear door of the engine compartment, and secure it with three cap screws.

86. FANS.

a. **Description.** Two 26-inch diameter, six-blade blower or pusher-type fans are used. They are mounted in the front of the radiator. The fans draw air in through the openings in the engine compartment doors (or from the fighting compartment), and force the air out through the radiator and air baffles back of the radiator. Each fan is driven by two matched V-belts (B-197369) (fig. 98) from pulleys on the accessory drive housings (mounted on the sides of the hull toward the rear of the engine compartment).

b. **Fan Belt Replacement or Adjustment** (fig. 98). Replacement or adjustment of the fan belts is accomplished by moving the

TANK, MEDIUM, M4A3

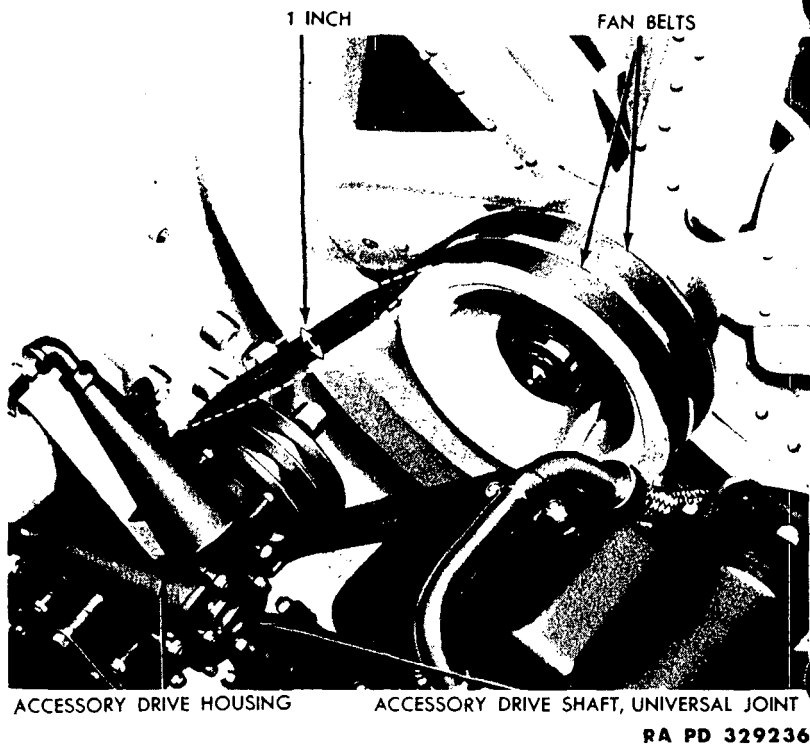

Figure 98—Fan Belt Adjustment

accessory drive housing up or down in slots provided for this purpose, after loosening the four nuts which secure the housing to the engine compartment sides. The belts are correctly adjusted when approximately 1-inch movement can be obtained with the fingers at a point midway between the fan and accessory drive pulleys (fig. 98). **NOTE:** *When replacement of belts is made, always replace both belts running on the same pulleys.*

c. Fan Bearing Lubrication. The fan bearings are packed when assembled, and should require no further lubrication between overhaul periods.

d. Fan and Shroud Assembly Replacement. To remove the fans and shrouds, open the engine compartment doors, and remove the engine compartment rear cover plate. It is not necessary to remove the engine compartment doors. Loosen and remove the fan belts (subpar. b above). Remove the two bolts and four cap screws from each fan shroud, and remove the assemblies. To install the fan and shroud assembly, place them in position and secure them to the

COOLING SYSTEM

hull with four cap screws and two bolts. Install the fan belts (subpar. b above). Install the engine compartment rear cover plate. Close the engine compartment doors.

87. ACCESSORY DRIVES.

a. **Description.** The accessory drives are located on the right and left walls of the engine compartment to the rear of the engine. These accessory drives contain bevel gears running in engine oil which transmit the power from the engine accessory shafts to drive the fans. The accessory drives are provided with bayonet-type oil level gages, which are a part of the filler plugs.

b. **Replacement.** Remove the accessory drive shaft (par. 112 c). Loosen the four nuts securing the accessory drive housing to the engine compartment side wall, and lift the assembly so that the fan belts can be removed from the pulleys. Take off the nuts, and remove the accessory drive assembly from the hull. The above procedure applies to either the right or left accessory drive. To install the accessory drive assembly, place it in position over the studs in the hull, and install the nuts on the studs loosely. Install the fan belts, and lower the assembly to adjust the belts. Tighten the nuts to secure the accessory drive assembly to the side wall. Install the accessory drive shaft.

88. THERMOSTAT.

a. **Description** (fig. 99). The thermostat located in the inlet opening of the radiator is of the by-pass bellows type, and is non-adjustable. This thermostat prevents the circulation of water in the radiator until the engine reaches normal operating temperature. The thermostat starts to open at 140°F.

b. **Removal.** Open the engine compartment doors. Remove the drain plug at the bottom of the water pump (fig. 78), and drain out enough water (approximately 2 gallons) to bring the level below the thermostat. Remove the four cap screws from the radiator upper water connections. Loosen the hose clamps from both radiator upper hose at the engine, and at the thermostat housing. Remove the hose. Remove the water connection and the thermostat from the radiator (fig. 99).

c. **Installation.** Place the thermostat, with a new gasket, in position in the radiator upper connection. Place the radiator upper connection in position with a new gasket, and secure it to the radiator with four cap screws. Install the drain plug in the bottom of the water pump, and add coolant in the cooling system to the proper level. Close the engine compartment doors.

TANK, MEDIUM, M4A3

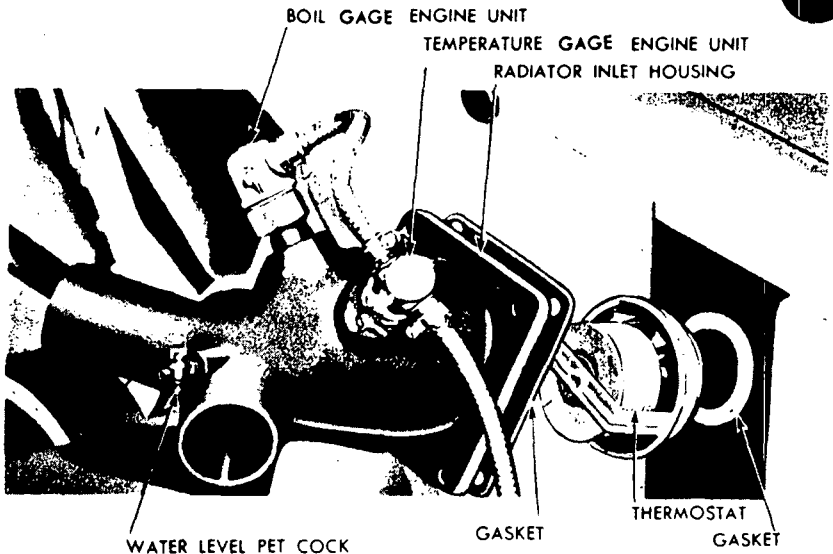

RA PD 335173

*Figure 99—Thermostat***89. EXPANSION TANK.**

a. **Description** (fig. 100). The expansion tank, located on the bulkhead at the front of the engine, catches the water or steam that may be forced out of the cooling system. When a sufficient pressure (12 lb) is built up in the cooling system due to expansion of the coolant, the pressure valve in the filler cap opens, and the excess water or steam goes into the expansion tank. As the engine cools, a vacuum is formed in the sealed cooling system, drawing water back into the cooling system through a vacuum valve in the pressure cap (fig. 100).

b. **Removal.** Open the engine compartment doors. Open the water level petcock (fig. 99), and drain out water to the level of the petcock. Close the petcock. Loosen the clamp on the left-hand air cleaner tube at the air intake manifold, and remove the tube from the manifold. Remove the two cap screws from the fire extinguisher bracket which hold it to the bulkhead at the left of the expansion tank. Unscrew the fire extinguisher nut from the pipe. Remove the fire extinguisher nozzle and bracket. Loosen the hose clamps at the bottom of the expansion tank, and remove the hose from the tank. Remove the four cap screws which hold the expansion tank bracket to the bulkhead. Lower the expansion tank until it rests on the

COOLING SYSTEM

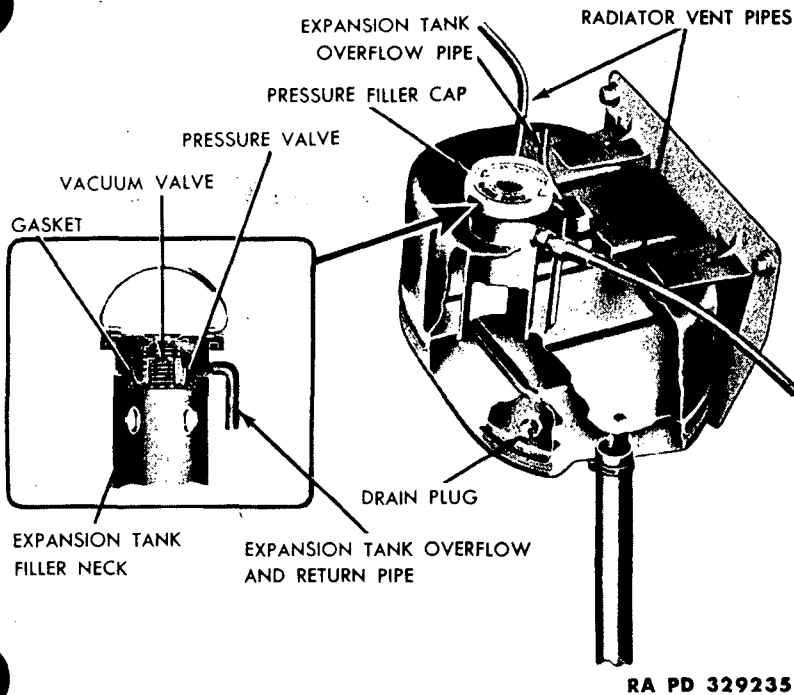

RA PD 329235

Figure 100—Radiator Filler and Expansion Tank

buretor air intake manifold. Disconnect the radiator vent pipes on either side of the filler neck, working through the filler cap hole in the engine compartment front plate. Remove the expansion tank.

c. Installation. Place the expansion tank and bracket assembly in position, with the tank resting on the carburetor air intake manifold. Connect the radiator vent pipes, working through the filler cap hole in the engine compartment front plate. Secure the expansion tank and bracket assembly to the bulkhead with the four cap screws. Install the hose at the bottom of the expansion tank, and tighten the clamps. Connect the fire extinguisher nozzle to the pipe, and secure the fire extinguisher nozzle and bracket to the bulkhead with two cap screws. Install the left-hand air cleaner tube on the carburetor air intake manifold, and tighten the clamp. Close engine compartment doors.

d. Expansion Tank Drainage. To drain the expansion tank, remove the drain plug on the right side of the tank (fig. 100).

TANK, MEDIUM, M4A3

Section XIX

INSTRUMENT PANEL AND INSTRUMENTS

90. INSTRUMENT PANEL (EARLY TYPE).

a. **Description** (fig. 13). The early type instrument panel is provided with a primer pump. The wiring for the instruments runs from the instruments directly to the terminal boxes and to the battery box.

b. **Disassembly.** Turn the battery master switch off. Disconnect the two primer pump lines at the top of the instrument panel. Loosen the knurled nut which holds the speedometer trip reset conduit to the clip at the bottom of the panel and remove the conduit. Remove the six screws which hold the panel to the case and separate the panel from the case. Disconnect the tachometer and speedometer drive cables. The panel may now be laid face down on the sponson to remove any of the wires, instruments, or devices as required.

c. **Assembly.** Connect the tachometer and speedometer drive cable to the tachometer and speedometer heads. Hold the panel in place on the case and install the six screws in the panel. Connect the speedometer trip reset conduit to the clip at the bottom of the panel. Connect the two primer lines to the fittings at the top of the instrument panel.

91. INSTRUMENT PANEL (LATER TYPE).

a. **Description.** The late-type instrument panels are provided with plug connectors which permit the wiring to be disconnected at the rear of the instrument panel. The plug-type connectors enable easy removal of the instrument panel from the vehicle.

b. **Disassembly.** Disconnect the tachometer and speedometer drive cables from the tachometer and speedometer heads at the rear of the panel. Remove the six equally spaced screws on the outer edge of the instrument panel. Separate the two halves of the panel to gain access to the instruments.

c. **Assembly.** Hold the two halves of the instrument panel together and install the six equally spaced screws in the panel. Connect the speedometer and tachometer drive cables to the speedometer and tachometer heads at the rear of the panel.

d. **Replacement.**

(1) **REMOVAL.** Disconnect the speedometer and tachometer drive cables from the speedometer and tachometer heads at the rear

INSTRUMENT PANEL AND INSTRUMENTS

the panel. Unscrew the three plug connector collars and pull the three plug connectors from their sockets. Remove the three nuts and washers that secure the panel to the brackets and remove the panel.

(2) **INSTALLATION.** Hold the instrument panel in position on the brackets and install the three nuts and washers. Install the three plug connectors in their proper sockets and tighten the three plug connector collars. Connect the speedometer and tachometer drive cables to the speedometer and tachometer heads at the rear of the panel.

92. INSTRUMENTS.

a. **Panel Unit Replacement.** To remove any instruments, switches, or devices, disassemble the instrument panel as outlined in paragraphs 90 b or 91 b. Remove the hold-down screws from the instrument and disconnect the wires. Lift the instrument from the panel. To install the instrument, connect the wires to the instrument and install the instrument in the panel. Assemble the instrument panel as outlined in paragraphs 90 c or 91 c.

b. Sending Unit Replacement.

(1) **SPEEDOMETER OR TACHOMETER DRIVE CABLE.** Disconnect the tachometer drive cable as outlined in paragraphs 90 b or 91 b. Pull the cable (G104-17-89553) from the housing. If the cable is broken and a portion remains in the housing, disconnect the housing from the drive unit on the transmission (later-type vehicles) or from the drive unit on the engine (early-type vehicles). Pull the remaining portion of the drive cable from the housing and connect the housing to the drive unit from which it was removed. Lubricate the new drive cable and push it in the housing, and at the same time twist the cable to permit an easy entry. Connect the drive cable housing to the instrument panel as outlined in paragraphs 90 c or 91 c.

(2) **WATER TEMPERATURE GAGE (ENGINE UNIT).** Remove the shield from the water temperature gage (A-297237) (engine unit) (fig. 99). Disconnect the wire. Unscrew the unit from the radiator inlet housing. To install the temperature gage (engine unit), screw it into the radiator inlet housing. Connect the wire to the unit. Install the shield on the unit.

(3) **HIGH WATER TEMPERATURE OR BOIL SIGNAL GAGE (ENGINE UNIT).** Remove the shield from the high water temperature gage or boil signal (A-345789-A) (engine unit) (fig. 99). Disconnect the wire from the unit and unscrew the unit from the radiator inlet housing. To install the high water temperature or boil signal (engine unit) screw it into the radiator inlet connection. Connect the wire to the unit and install the shield.

TANK, MEDIUM, M4A3

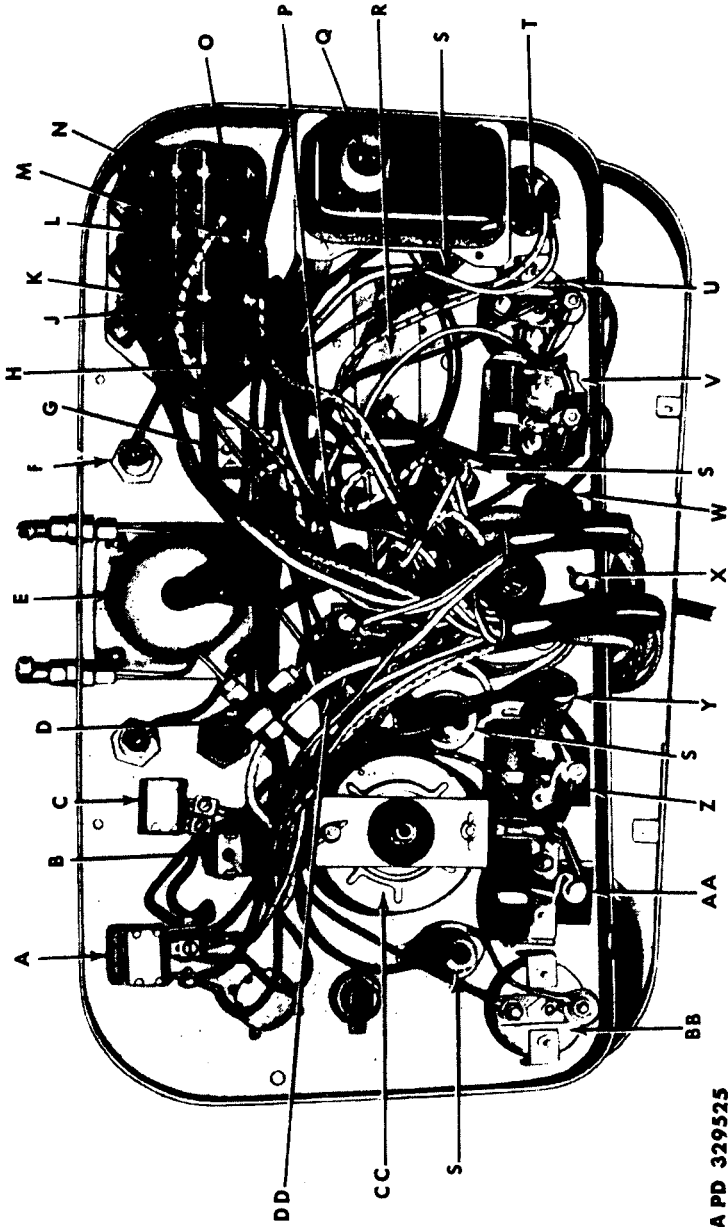

RA PD 329525

Figure 101—Back of Instrument Panel (75-mm Dry Storage Vehicles)

INSTRUMENT PANEL AND INSTRUMENTS

- A**—MAIN LIGHT SWITCH
B—STARTER BUTTON
C—B.O. DRIVE SWITCH
D—PRIMER PUMP
E—IGNITION SWITCH
F—UTILITY OUTLET
G—FUEL CUT-OFF SWITCH
H—CIRCUIT BREAKER (NOT USED)
J—INSTRUMENT CIRCUIT BREAKER
K—LIGHT CIRCUIT BREAKER
L—UTILITY OUTLET CIRCUIT BREAKER
M—FUEL CUT-OFF CIRCUIT BREAKER
N—CIRCUIT BREAKER FOR B.O. DRIVE LIGHT CIRCUIT
O—CIRCUIT BREAKER FOR SIREN CIRCUIT
P—AMMETER
Q—FIRE DETECTOR (NOT USED)
R—CLOCK
S—INSTRUMENT PANEL LIGHT
T—FUEL TANK SELECTOR SWITCH
U—FUEL GAGE
V—WATER TEMPERATURE GAGE
W—WATER BOIL SIGNAL
X—SPEEDOMETER
Y—LOW OIL PRESSURE SIGNAL
Z—OIL PRESSURE GAGE
AA—OIL LEVEL GAGE (NOT USED)
BB—TRANSMISSION OIL TEMPERATURE GAGE
CC—TACHOMETER
DD—VOLT METER (NOT USED)

4A PD 329525A

Legend for Figure 101

TANK, MEDIUM, M4A3

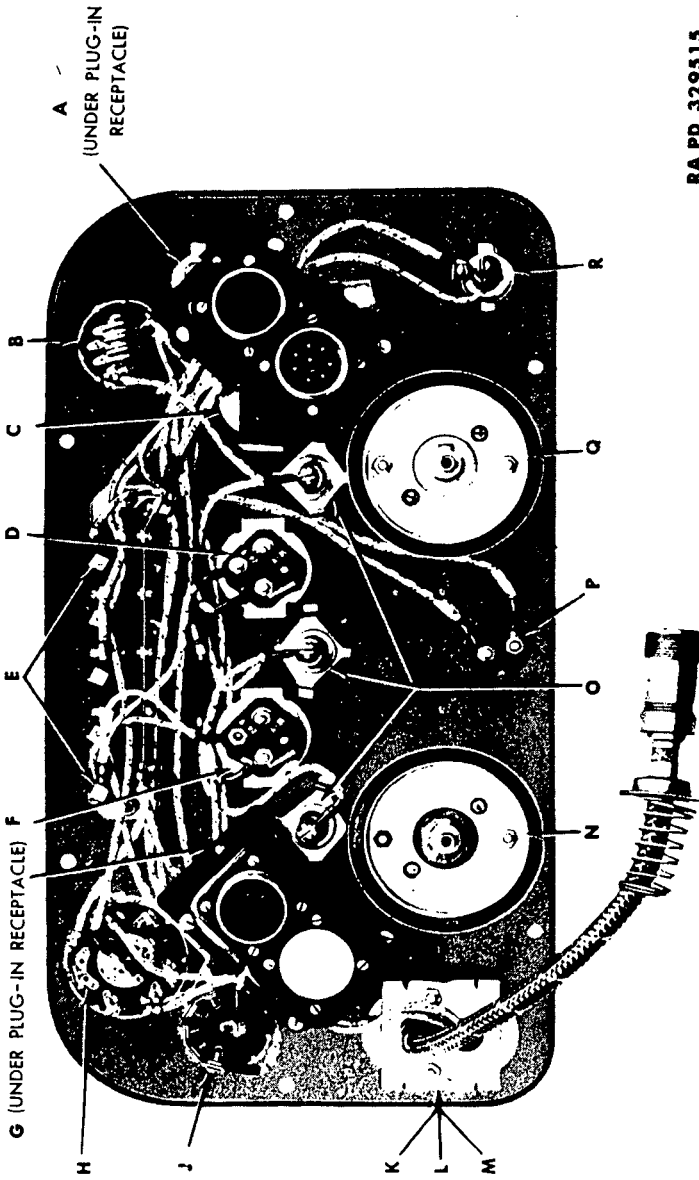

RA PD 329515

Figure 102—Back of Instrument Panel (75-mm Howitzer, 76-mm Howitzer, and 105-mm Howitzer Vehicles)

INSTRUMENT PANEL AND INSTRUMENTS

RA PD 329515A

- A—UTILITY OUTLET (UNDER PLUG-IN RECEPTACLE)
- B—PANEL LIGHT SWITCH
- C—AMMETER
- D—OIL PRESSURE GAGE
- E—CIRCUIT BREAKERS
- F—TEMPERATURE GAGE
- G—FUEL GAGE (UNDER PLUG-IN RECEPTACLE)
- H—LIGHT SWITCH
- J—FUEL GAGE SELECTOR SWITCH

- K—IGNITION SWITCH
- L—STARTER SWITCH
- M—BOOSTER SWITCH (NOT USED)
- N—TACHOMETER
- O—PANEL LIGHTS
- P—FUEL CUT-OFF
- Q—SPEEDOMETER
- R—HI WATER TEMPERATURE AND
LOW OIL PRESSURE SIGNAL LIGHT

Legend for Figure 102

TANK, MEDIUM, M4A3

(4) OIL PRESSURE GAGE (ENGINE UNIT).

(a) *Early-type Vehicles.* The oil pressure gage (A-297238) and the low oil pressure gage (engine units) are mounted side by side, just inside and to the right of the engine compartment rear door. The pressure unit can be identified from the low oil pressure unit as it is mounted vertically. To remove the unit, remove the shield from the unit and disconnect the wire. Unscrew the unit from the bracket. To install, attach the unit to the bracket. Connect the wire to the unit and install the shield.

(b) *Later-type Vehicles.* The oil pressure gage on the later-type vehicles is the unit located on the right-hand side of the engine below the exhaust manifold and nearest to the fighting compartment bulkhead. To remove the unit, remove the shield and disconnect the wire from the unit. Unscrew the unit from the engine. To install the unit, screw it into the engine. Connect the wire to the unit and install the shield.

(5) LOW OIL PRESSURE GAGE (ENGINE UNIT).

(a) *Early-type Vehicles.* To replace the unit, follow the same procedure as outlined in step (4) (a) above. The low oil pressure gage (engine unit) (248045) and the pressure gage are mounted side by side, just inside and to the right of the engine compartment rear door. The low oil pressure unit can be identified from the pressure unit as it is mounted horizontally.

(b) *Later-type Vehicles.* The low oil pressure gage (engine unit) on later-type vehicles is located on the right-hand side of the engine below the exhaust manifold and to the rear of the oil pressure unit. To replace the low oil pressure gage (engine unit) follow the procedure as outlined in step (4) (b) above.

(6) OIL LEVEL GAGE. Tanks of current production are not equipped with oil level gages. If, on an older vehicle, the engine unit or gage becomes inoperative, disconnect it as follows:

(a) Disconnect the battery wire from the oil pressure gage to the oil level gage on the instrument panel. Remove and discard the wire.

(b) Leave the oil level instrument panel gage mounted on the instrument panel, and paint the face of the gage the same color as the instrument panel.

(c) Remove from the engine oil pan oil level sending unit, the two screws which hold the two halves of shielding together.

(d) Disconnect the wire from the terminal on the sending unit, and the terminal box. Discard wires, shields, and screws.

ELECTRICAL SYSTEM**COMPASS.**

a. A compass is located on the left sponson in the driver's compartment. A light is incorporated in the compass which is connected in series with the instrument panel lights.

Section XX**ELECTRICAL SYSTEM****94. DESCRIPTION.**

a. A 24-volt electrical system is used in all M4A3 vehicles. The instrument panel wiring diagram is shown in figures 101 and 102. The wiring of the hull is shown in figures 103 and 104. The wiring of the turret is shown in figures 105 through 108. The electrical current is brought to the turret through a collector ring (figs. 105 through 108). An auxiliary generator, equipped with a small 2-cycle engine, is provided to supply extra electrical power and aid in charging the batteries.

BATTERIES.

a. **Description** (figs. 113 and 114). Two 12-volt storage batteries (500908) are located either on the left sponson in the fighting compartment or under the turret platform. The batteries are connected in series, and provide 24-volt current by a direct and separate connection between the batteries and the battery master switch. A separate connection for the rear battery, only to the radio master switch, provides 12-volt current for the radio equipment. On later vehicles, a socket, located directly under the master switches, is provided for plugging in a booster battery.

b. **Replacement.** Turn off both the battery and radio master switches. Disconnect the battery cables at the batteries and remove the hold-down bolts and hold-down brackets, remove the batteries. To install the batteries, place them in the battery compartment. Install the battery hold-down brackets and bolts, and connect the battery cables.

c. **Battery Heater Unit** (fig. 121).

(1) **DESCRIPTION.** The battery heater unit is located on the left sponson, directly under the auxiliary generator fuel tank. Earlier models are not equipped with this unit. The battery heater unit is connected in series with the auxiliary generator and is used to heat batteries for cold weather starting (par. 25 d).

TANK, MEDIUM, M4A3

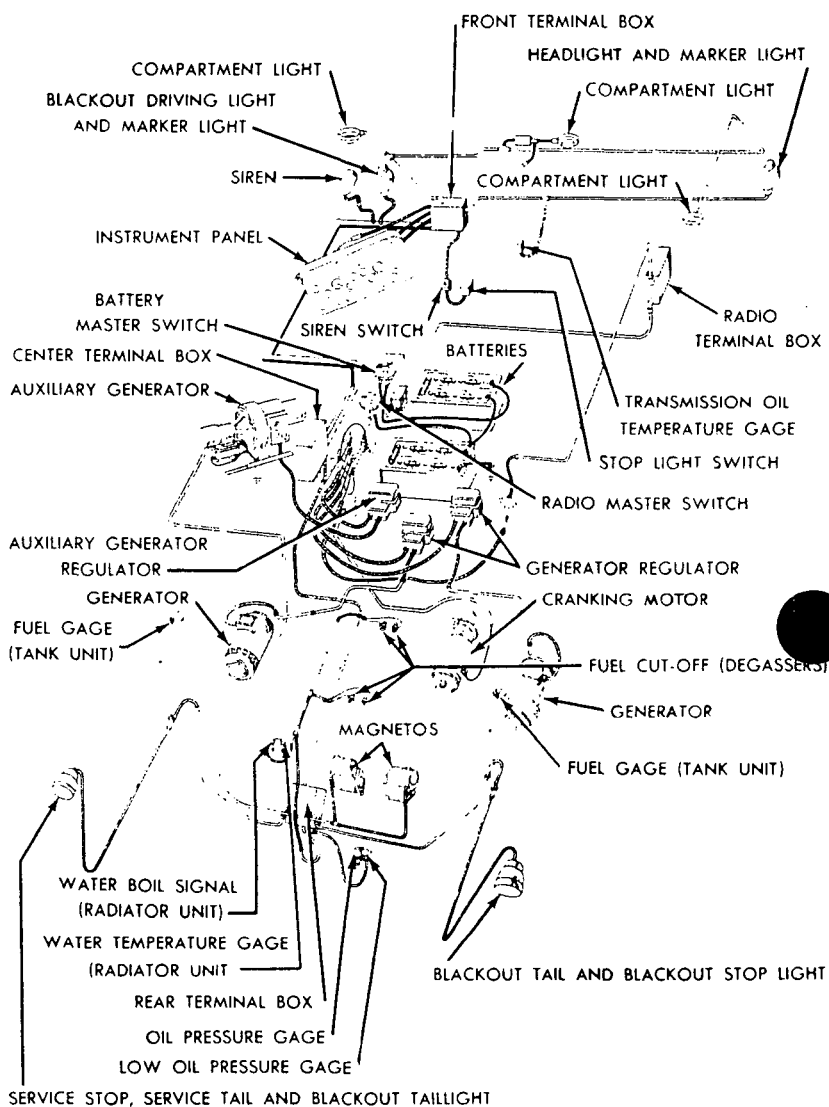

RA PD 329313

Figure 103—Hull Electrical System (75-mm Dry Stowage Vehi

ELECTRICAL SYSTEM

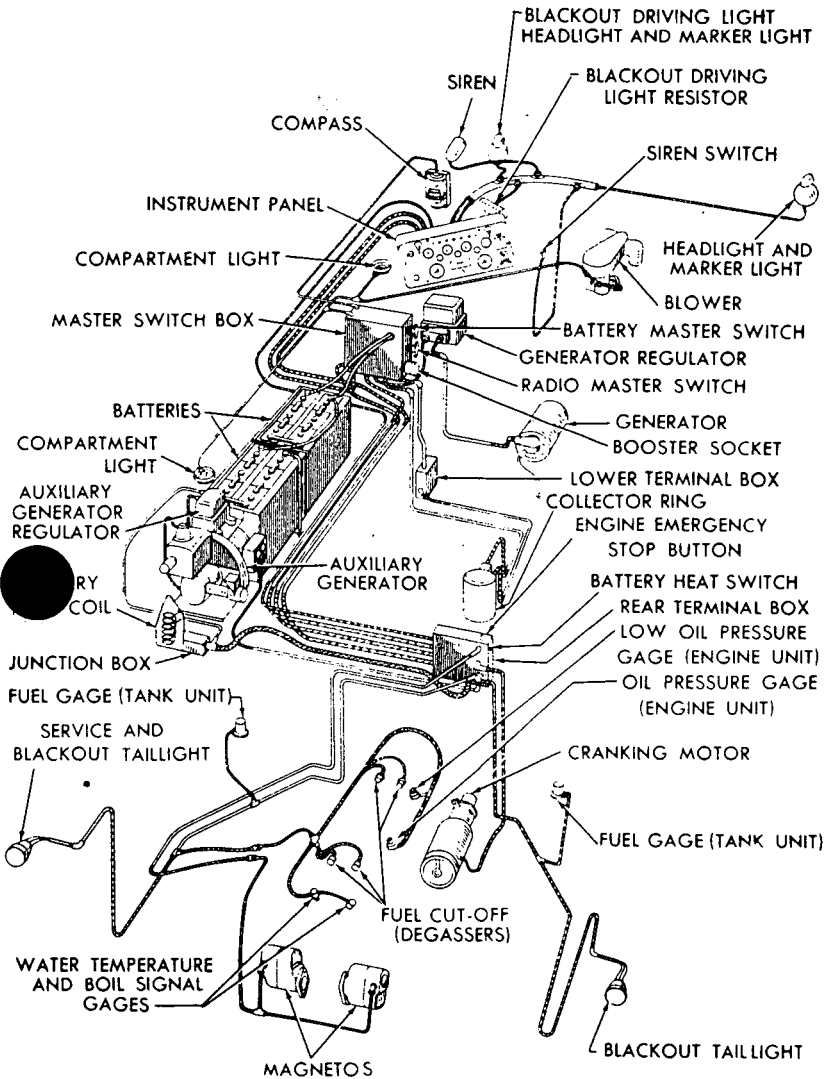

RA PD 329315

Figure 104—Hull Electrical System (175-mm Wet Stowage, 160-mm, and 105-mm Howitzer Vehicles)

TANK, MEDIUM, M4A3

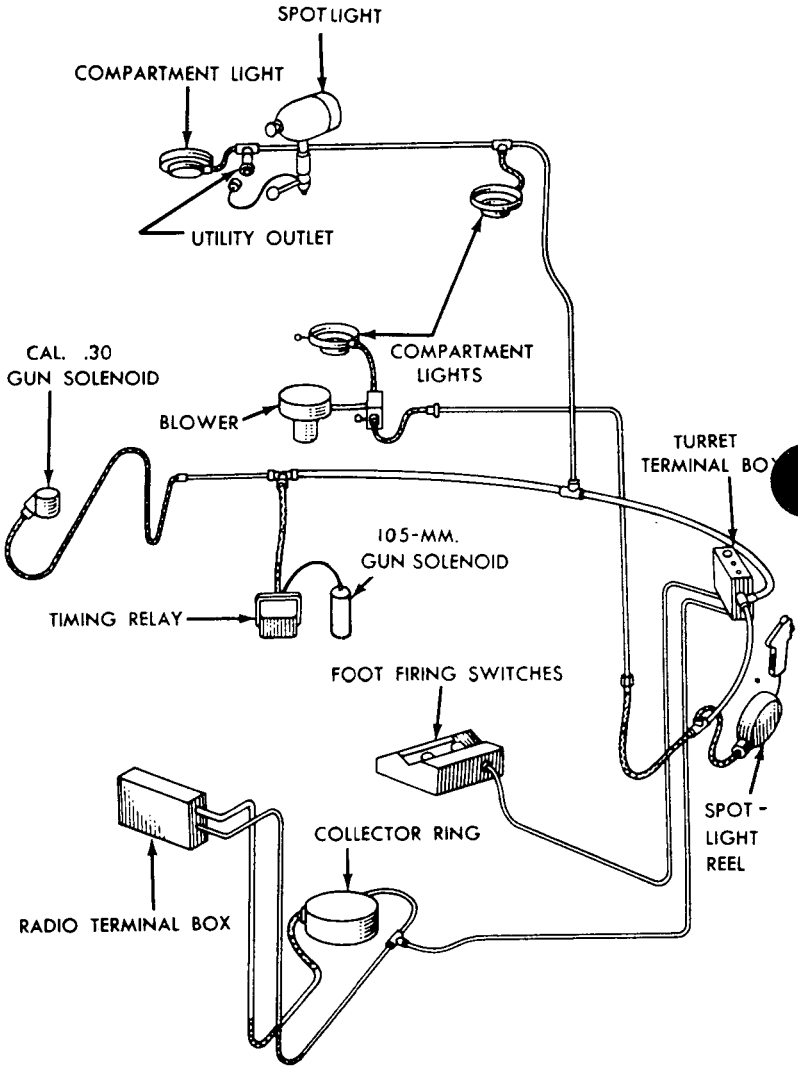

RA PD 329394

Figure 105—Turret Electrical System (105-mm Howitzer Vehicle)

ELECTRICAL SYSTEM

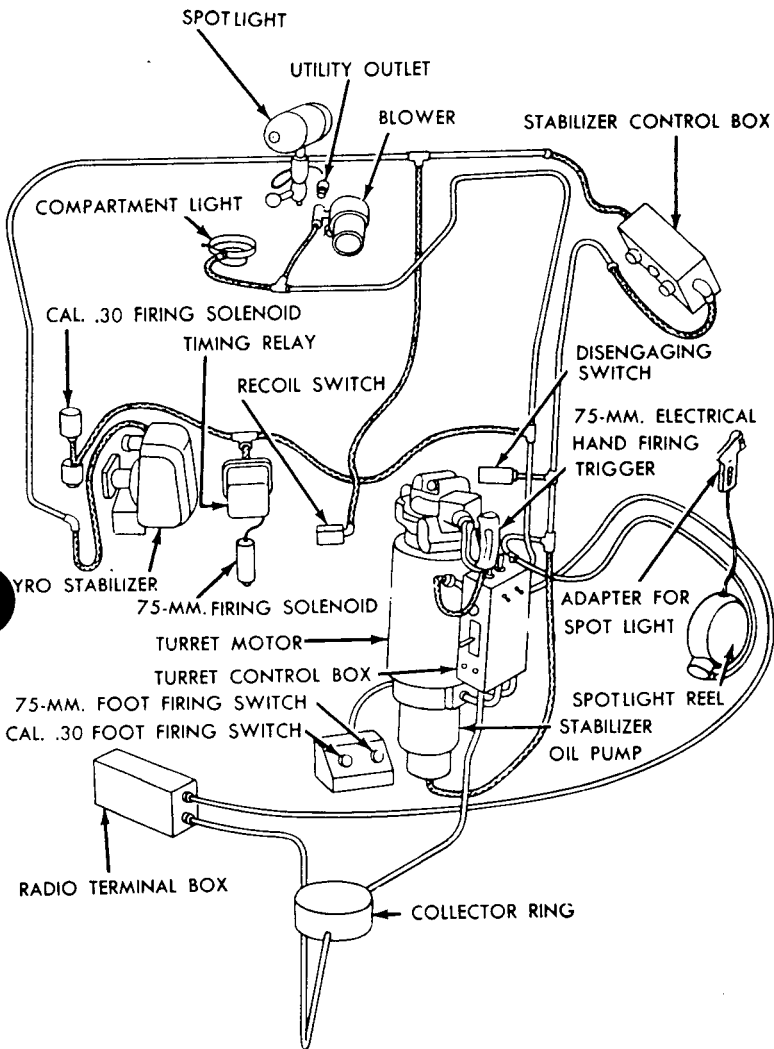

RA PD 329316

Figure 106—Turret Electrical System (175-mm Wet Stowage Vehicles)

TANK, MEDIUM, M4A3

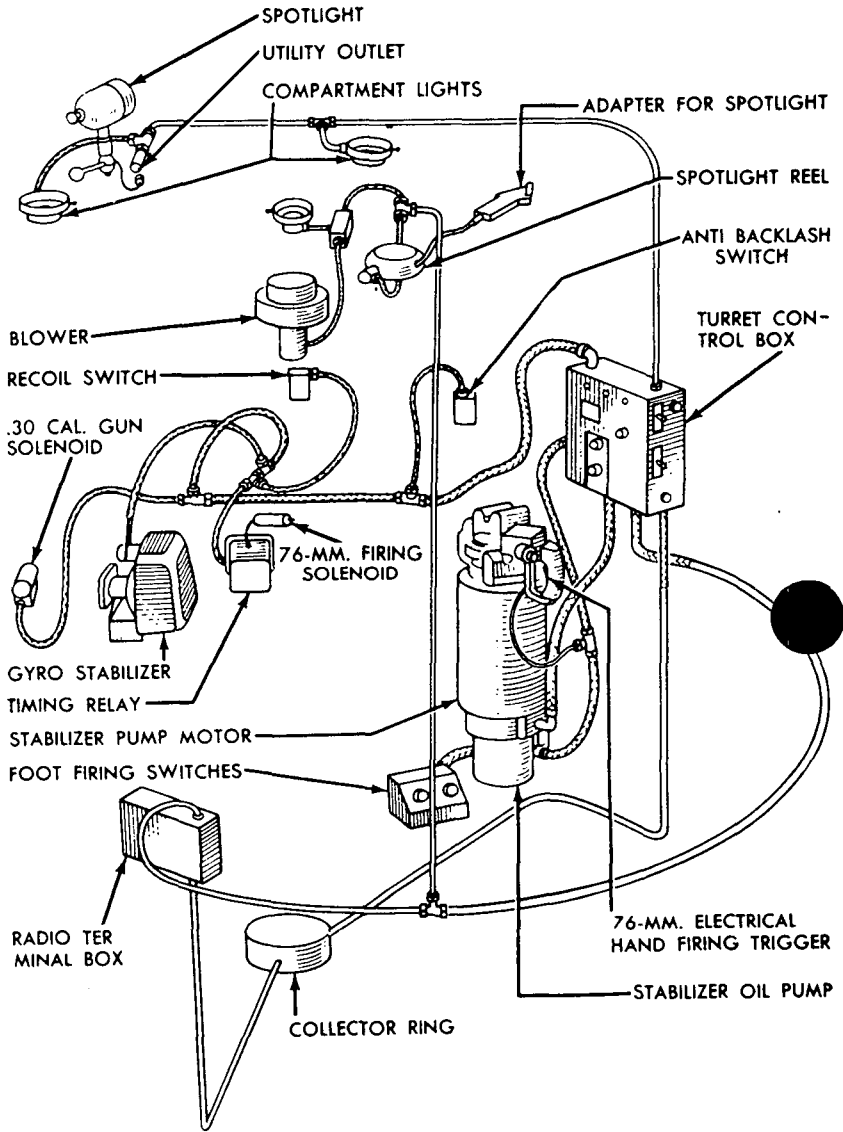

RA PD 329592

Figure 107—Turret Electrical System (76-mm Vehicles)

ELECTRICAL SYSTEM

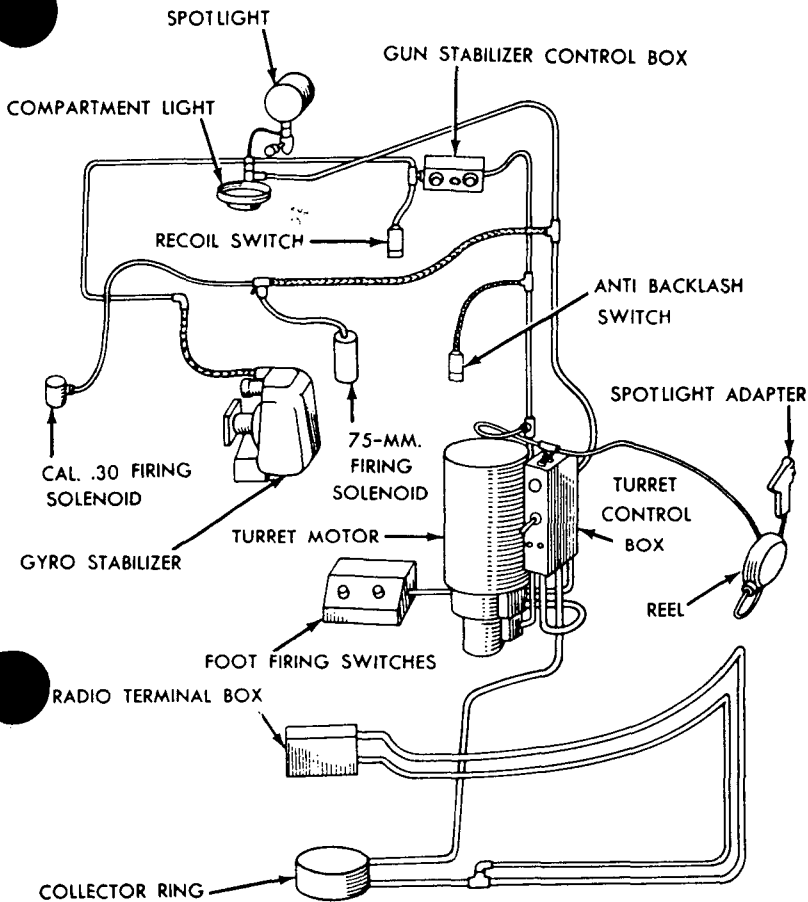

RA PD 329314

Figure 108—Turret Electrical System (175-mm Dry Storage Vehicles)

(2) **REPLACEMENT.** Remove the six screws holding the unit in the heater compartment. Remove the wire connections from the terminal posts and remove the unit (fig. 121). To install the coil, place it in position and connect the two wires to the coil and fasten the coil to the sponson with the six screws.

96. MASTER SWITCHES.

a. **Battery Master Switch** (figs. 113 and 115). The battery master switch (G103-17-93680) is located either to the left of the battery on the left sponson, or on top of the battery box under the

TANK, MEDIUM, M4A3

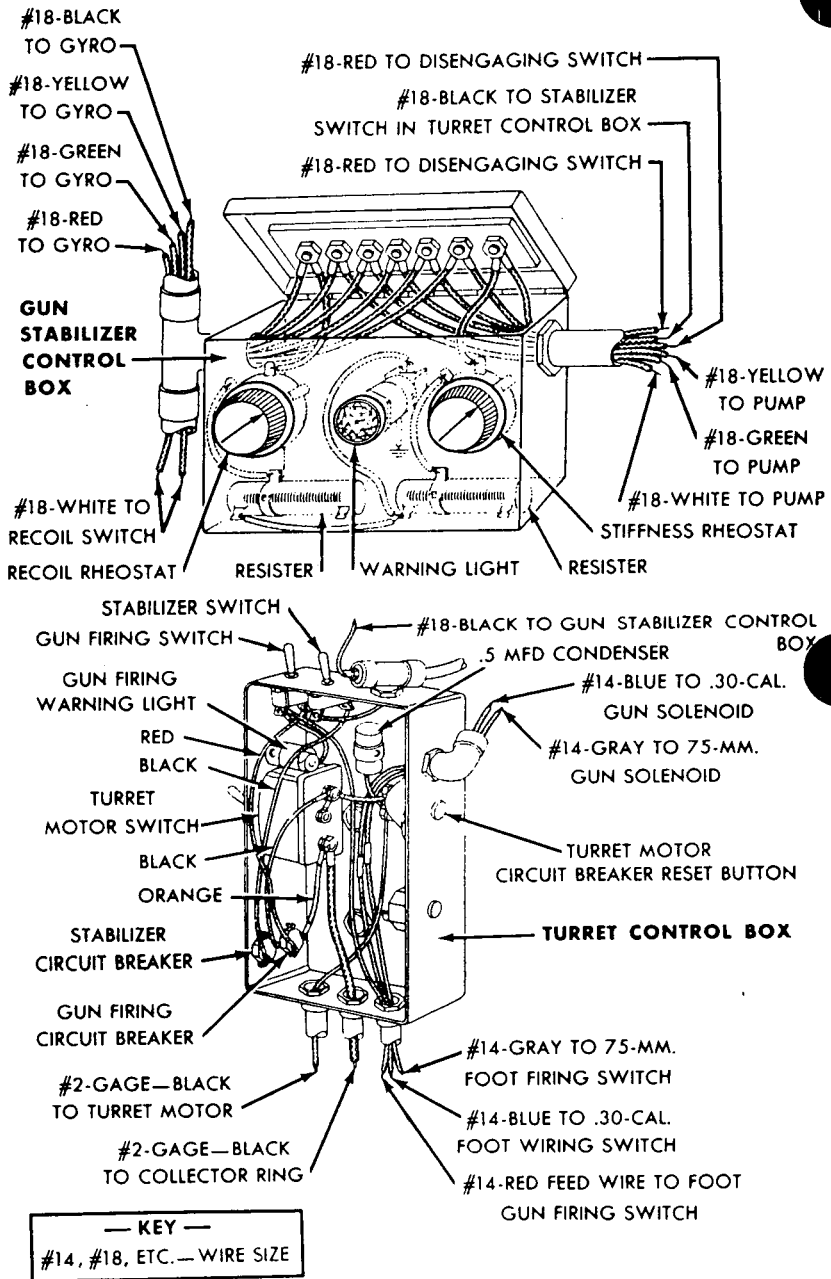

RA PD 329516

Figure 109—Gun Firing Circuit (75-mm Dry Stowage Vehicle)

ELECTRICAL SYSTEM

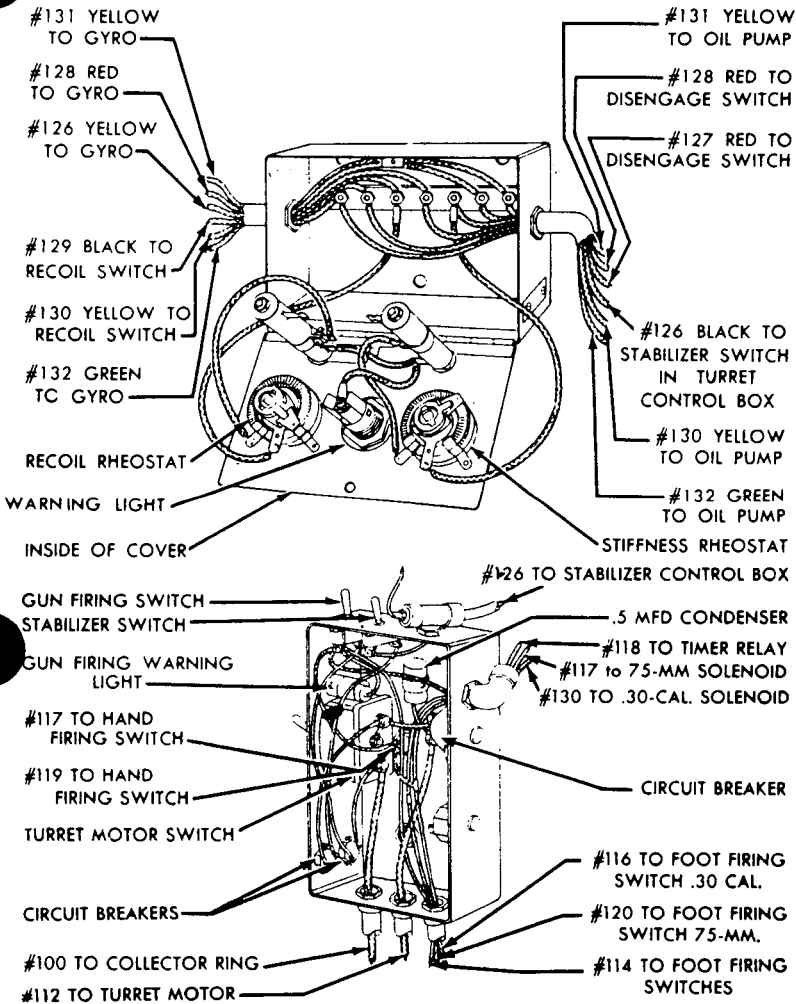

— KEY —

#100-WIRE	2-GAGE	#126-WIRE	18-GAGE
#112-WIRE	2-GAGE	#127-WIRE	18-GAGE
#114-WIRE	14-GAGE	#128-WIRE	18-GAGE
#116-WIRE	14-GAGE	#129-WIRE	18-GAGE
#117-WIRE	14-GAGE	#130-WIRE	14-GAGE
#118-WIRE	18-GAGE	#131-WIRE	18-GAGE
#119-WIRE	14-GAGE	#132-WIRE	18-GAGE
#120-WIRE	14-GAGE		

RA PD 329517

Figure 110—Gun Firing Circuit (75-mm Wet Stowage Vehicles)

TANK, MEDIUM, M4A3

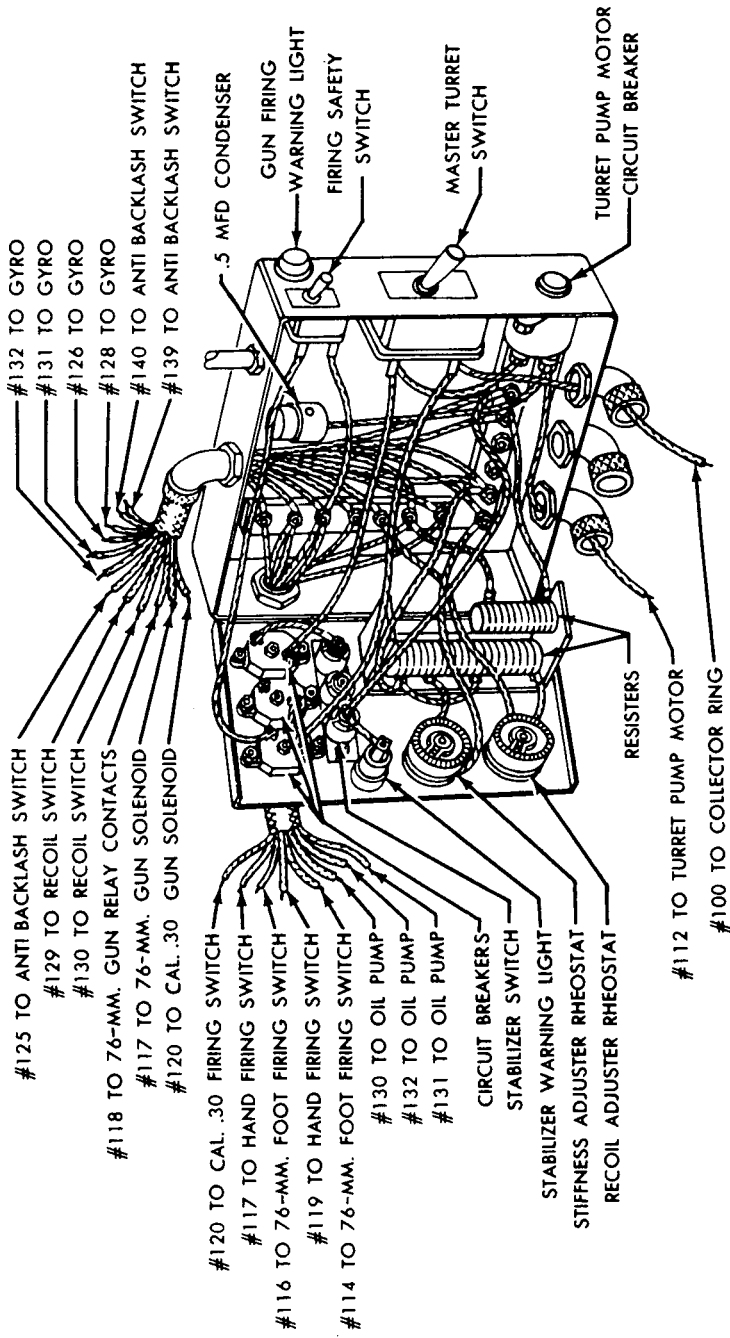

- #125 TO ANTI BACKLASH SWITCH
- #129 TO RECOIL SWITCH
- #130 TO RECOIL SWITCH
- #118 TO 76-MM. GUN RELAY CONTACTS
- #117 TO 76-MM. GUN SOLENOID
- #120 TO CAL. 30 GUN SOLENOID
- #132 TO GYRO
- #131 TO GYRO
- #126 TO GYRO
- #128 TO GYRO
- #140 TO ANTI BACKLASH SWITCH
- #139 TO ANTI BACKLASH SWITCH

- #120 TO CAL. 30 FIRING SWITCH
- #117 TO HAND FIRING SWITCH
- #116 TO 76-MM. FOOT FIRING SWITCH
- #119 TO HAND FIRING SWITCH
- #114 TO 76-MM. FOOT FIRING SWITCH
- #130 TO OIL PUMP
- #132 TO OIL PUMP
- #131 TO OIL PUMP

- CIRCUIT BREAKERS
- STABILIZER SWITCH
- STABILIZER WARNING LIGHT
- STIFFNESS ADJUSTER RHOESTAT
- RECOIL ADJUSTER RHOESTAT

- #112 TO TURRET PUMP MOTOR
- #100 TO COLLECTOR RING

RA PD 329446

Figure 111—Gun Firing Circuit (76-mm Vehicles)

ELECTRICAL SYSTEM

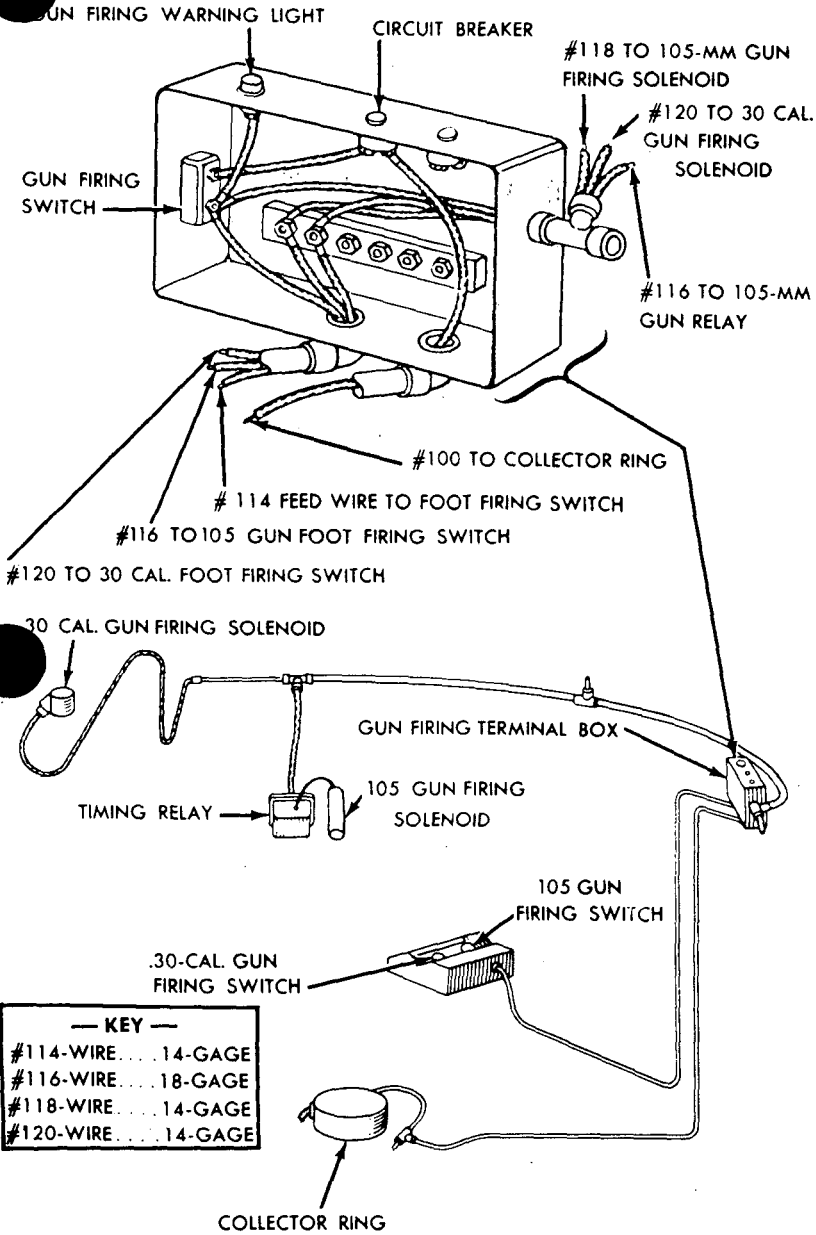

RA PD 329518

Figure 112—Gun Firing Circuit (105-mm Howitzer Vehicles)

TANK, MEDIUM, M4A3

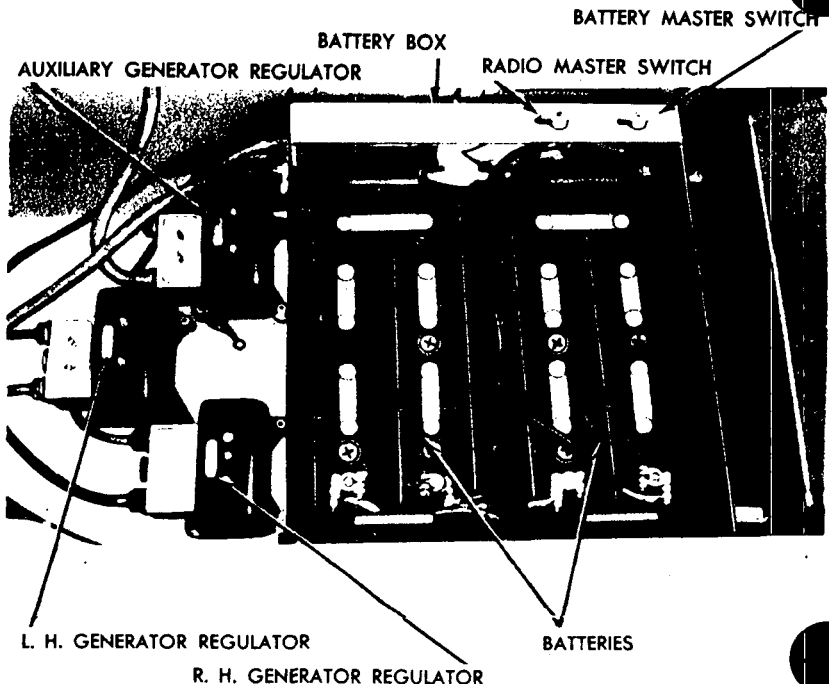

RA PD 329519

Figure 113—Batteries on Floor (Early Vehicles)

turret platform. When this switch is "OFF," all electrical power is shut off at the battery (with the exception of the power used by the radio, which is controlled by a separate radio master switch).

b. Radio Master Switch (figs. 113 and 115). The radio master switch is located either below or alongside the battery master switch. This switch is on when the knob is all the way in. To turn the switch off, pull the knob out $\frac{3}{4}$ inch and turn it so that the knob stays out.

c. Replacement (Either Switch). Disconnect the positive (+) battery terminal at the battery. Remove the four screws from the master switch box cover, and remove the cover. Remove the cable and wire connections from the switch. Remove the screws holding the switch to the switch box, and remove the switch. To install either switch in the master switch box, fasten the switch to the box with four screws. Attach the cables and wire connections to the switch. Secure the cover to the switch box with four screws.

ELECTRICAL SYSTEM

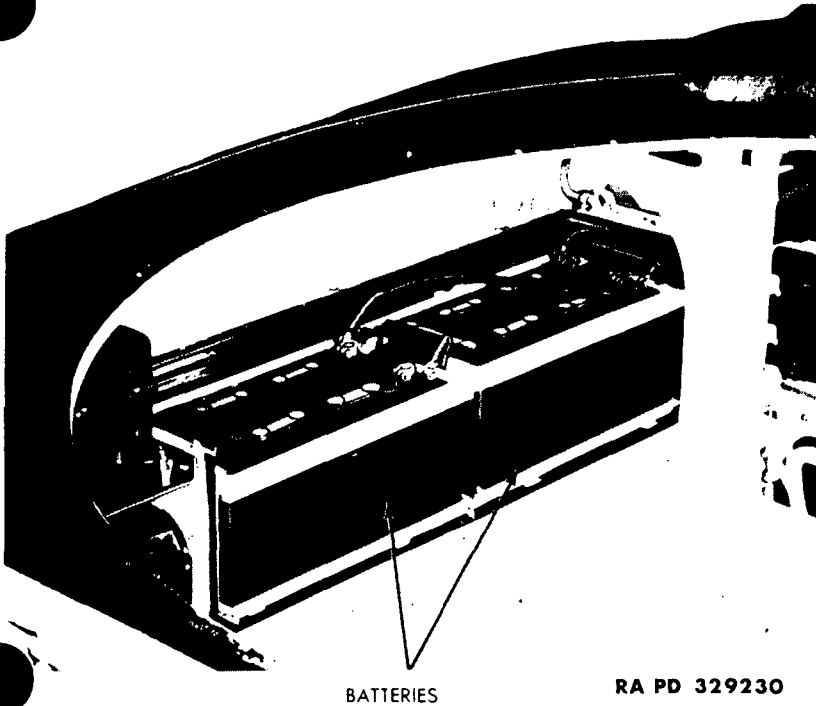

BATTERIES

RA PD 329230

*Figure 114—Batteries on Sponson (Later Vehicles)***97. HEADLIGHTS.**

a. **General.** The front slope of the vehicle mounts either two service headlight and blackout marker light combinations (G104-16-11515), or one blackout headlight (G104-16-11516), all of which are controlled by the light switch on the instrument panel. When changing from one type to the other, pull out the headlight lock (fig. 7) and turn it $\frac{1}{4}$ turn. The light assembly can then be lifted out. When neither the service headlights nor the blackout headlight are used, be sure to insert the plug provided for this purpose into the socket to protect the terminals. A wiring diagram of the light circuit is shown in figures 47 and 49.

b. Service Headlights.

(1) **DESCRIPTION.** The service headlights are used when there is a possibility that illumination ahead can be used with safety, and permit immediate change to blackout marker lights. The service headlight reflectors, however, can pick up and reflect back other lights, and under certain conditions the service headlights should

TANK, MEDIUM, M4A3

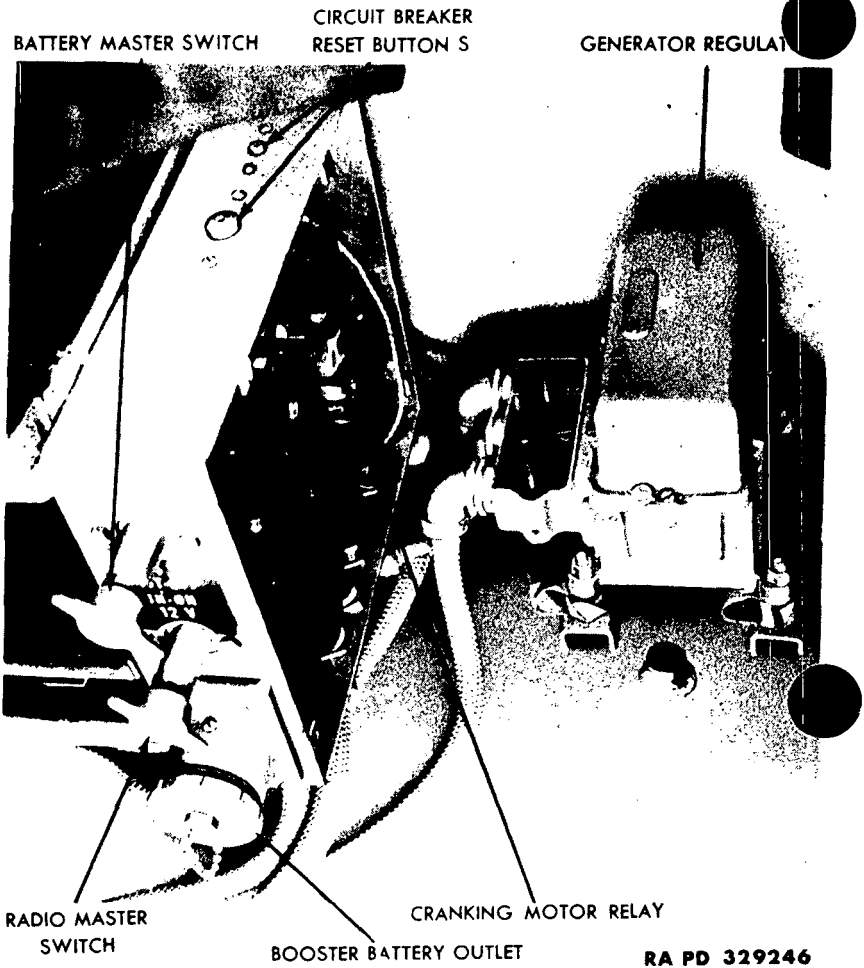

Figure 115—Location of Master Switches (Later Vehicles)

be removed. The service headlight uses a sealed beam, 24-volt, single-filament lamp. The blackout marker light, mounted on top of the service headlight, uses a single-contact, 24-volt, bayonet-base, 3-candlepower lamp.

(2) **SERVICE HEADLIGHT LAMP-UNIT REPLACEMENT.** Remove the headlight from the vehicle. Remove the screw that holds the lens frame to the body of the headlight and remove the frame. Disconnect the sealed beam lamp-unit (G104-18-19407), and lift it out of the headlight body. To install the lamp-unit, connect the wires and install the lamp and lens frame on the headlamp body.

ELECTRICAL SYSTEM

(3) **BLACKOUT MARKER LAMP REPLACEMENT.** Remove the headlight from the vehicle. Remove the screw that holds the lens frame to the headlight body, and remove the frame. Press the lamp (M001-02-13295) in and turn it slightly counterclockwise, then pull the lamp out of the socket. To install the lamp, press into the socket, and turn it clockwise. Install the lens frame on the blackout marker light body.

c. Blackout Headlight.

(1) **DESCRIPTION.** The blackout headlight throws a thin flat beam of light that cannot be seen from high above, yet provides enough illumination to permit the driver to avoid most obstacles. The lamp is of the sealed-beam type with only a narrow strip of the lens exposed, and a hood at the top. The lamp is 6-volt, 10-candle-power. A resistor is included in series in the circuit that permits this 6-volt lamp to be used in a 24-volt system.

(2) **BLACKOUT HEADLIGHT LAMP-UNIT REPLACEMENT.** Remove the screw that holds the lens frame to the blackout headlight body, and remove the frame. Unhook the six wire retainers with a screwdriver. Lift the lamp-unit (M001-01-07347) from the blackout headlight body, and disconnect the wires. To install the lamp-unit, connect the wires and place the lamp in the blackout headlight body. Install the six wire retainers and the lens frame.

98. TAILLIGHTS.

a. **Description.** Two taillights and bracket assemblies (G104-16-71650) (left) and (G104-16-71649) (right) are mounted on the rear of the vehicle, one on each side. The lamps in the two taillights are operated by the light switch on the instrument panel. Each taillight consists of two sealed-beam units, having pronged-type electrical connections to the filaments. The two sealed-beam units for each light are held in place by a frame, attached to the metal housing or body of the light with a screw. The taillights have two filaments each. One is used for service under ordinary conditions, and the other for blackout driving. Earlier models were equipped with a stop light, operated by switches connected to the steering levers.

b. **Taillight Sealed Beam Lamp-Unit Replacement.** Turn the battery master switch off. Remove the screw attaching the lens frame to the body of the taillight, and remove the frame. Pull the lamp-unit (G104-18-19404) straight out to remove it. To install the lamp-unit, push it in the socket, and install the lens frame.

99. UTILITY SOCKETS.

a. **Description.** Several utility sockets without switches are provided to provide an electrical outlet to operate windshield wiper, inspection lamp, etc. While no switches are provided for these

TANK, MEDIUM, M4A3

sockets, they are in series with the battery master switch which must be turned on before current is available. The following is only a general procedure for replacing defective sockets. A wiring diagram of the turret light circuit is shown in figures 51 and 53.

b. Replacement.

- (1) Turn off battery master switch.
- (2) Remove or loosen whatever is necessary to gain access to the rear side of the socket.
- (3) Remove taps from wires leading to socket.
- (4) Disconnect and tag wires.
- (5) Remove lock nut from socket and remove socket.

100. COMPARTMENT LIGHTS.

a. General. Compartment lights are provided on the ceiling in the turret and in the driver and assistant driver's compartment. Each light is provided with its own toggle switch. However, the lights are in series with the battery master switch which must be "ON" before the lights can be turned on. These lights are equipped with a 24-volt, 3-candlepower, bayonet base lamp. A wiring diagram of the hull light circuit is shown in figures 47 and 49. The turret light circuit is shown in figures 50 and 51.

b. Removal.

- (1) Remove the two screws that hold the bezel in place and remove the bezel and lens.
- (2) Push the lamp (M001-02-13295) in, turn it slightly counter-clockwise, and withdraw the lamp.

c. Installation. Fasten the lamp in the socket. Install the bezel and lens in place. Install the two screws holding the bezel and lens.

101. CONDUIT AND CABLES.

a. Description. Two objectives are achieved by the use of flexible and rigid metal conduit and junction boxes over the high- and low-tension automotive wire used in these vehicles. The conduit protects the insulation of the wire against wear and abrasion, and it is oil- and waterproof. Radio interference is cut to a minimum because the conduit and junction box provide a continuous grounded circuit over the entire wiring system.

b. Replacement.

- (1) **CONDUIT REPLACEMENT.** Dented or cracked conduits, or conduits with damaged couplings, must be replaced. Flexible

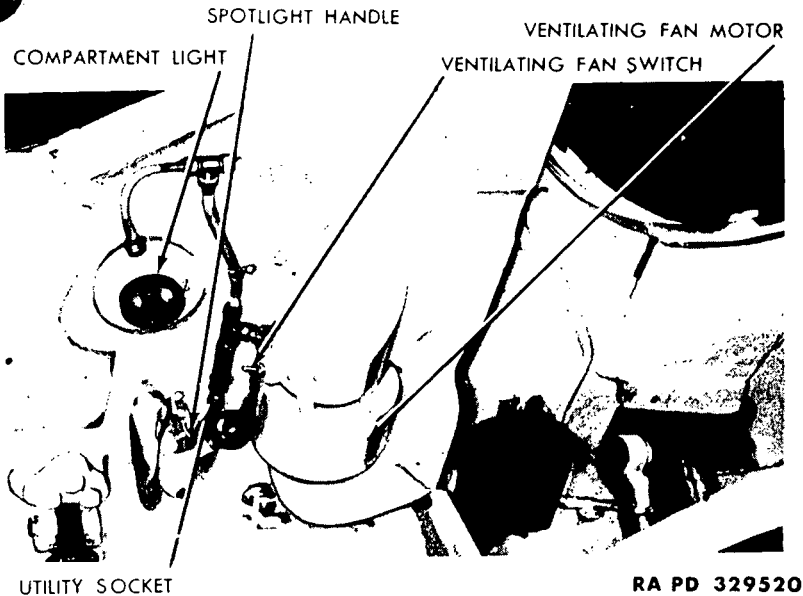
ELECTRICAL SYSTEM

RA PD 329520

Figure 116—Typical Compartment Light

tions of a conduit which have become frayed must be replaced. The main conduits are made up in sections and, in most cases, they can be replaced without disturbing undamaged sections.

(2) **WIRE REPLACEMENT.** In most cases, replacement of wires can be made without the necessity of removing the conduit from the vehicle. Remove the terminals from the defective wire, solder a piece of fish wire, longer than the conduit, to the end of the wire to be replaced. Pull the defective wire out of the conduit, pulling the fish wire in through the conduit at the same time. Cut a new piece of wire the same color and size as the one removed. Solder one end of the new wire to the fish wire. Rub wires with soapstone, to make pulling easier and to prevent jamming. Pull the fish wire back through the conduit, pulling the new wire or wires in place.

102. GENERATORS.

a. **Description.** On the early models, two generators (D-524488-D) are used. Each of the generators are mounted on an accessory drive housing on each side of the engine compartment. On the later models, one generator is used and is bracket mounted on rear of the transmission. This type of generator is belt driven

TANK, MEDIUM, M4A3

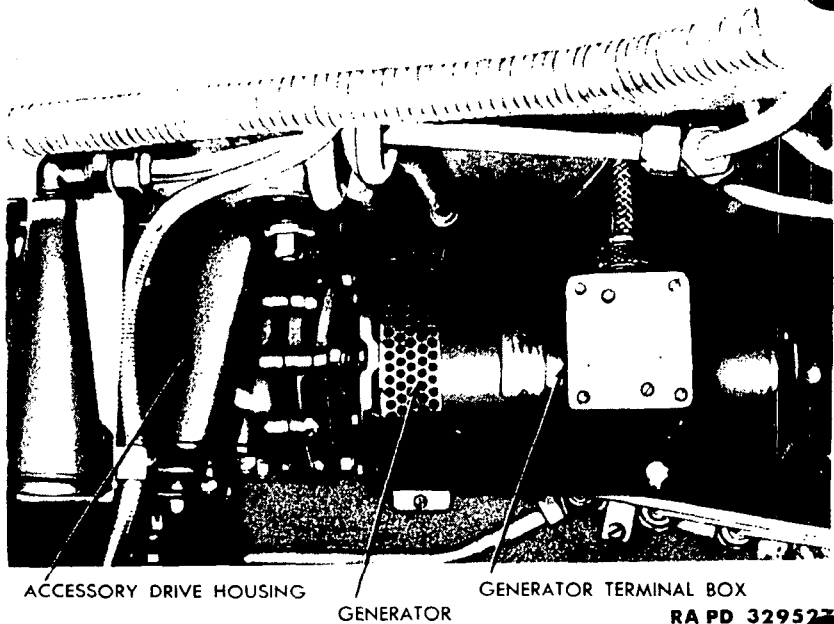

Figure 117—Generators (75-mm Dry Stowage Vehicles)

from the propeller shaft as shown in figure 119. Each generator has a 30-volt, 50 ampere capacity and is equipped with a generator regulator for current control. A radio interference filter is provided for each generator. This filter is located in, and is a part of each generator regulator. A separate wiring diagram covering the generator system is covered in figures 34 and 36.

b. Belt Adjustment. The generator belts No. B-298181 are adjusted correctly when they have $\frac{1}{2}$ -inch maximum movement midway between pulleys. To adjust the belts, loosen the lock nut on the generator belt adjustment bolt (fig. 118). Turn the bolt counter-clockwise to loosen the belts, and clockwise to tighten the belts. Tighten the lock nut after the adjustment is made.

c. Generator Replacement.

(1) **REMOVAL.** Remove the cover from the generator terminal box (fig. 118). Disconnect the field and armature terminals, on later models disconnect the ground wire at the generator. Remove the screws holding the terminal box to the generator and lift off the terminal box, wires, and conduit. Remove the bolts holding the generator to the mounting bracket or accessory drive housing and remove the generator.

ELECTRICAL SYSTEM

GENERATOR DRIVE BELT

ADJUSTMENT BOLT

GENERATOR

ARMATURE WIRE

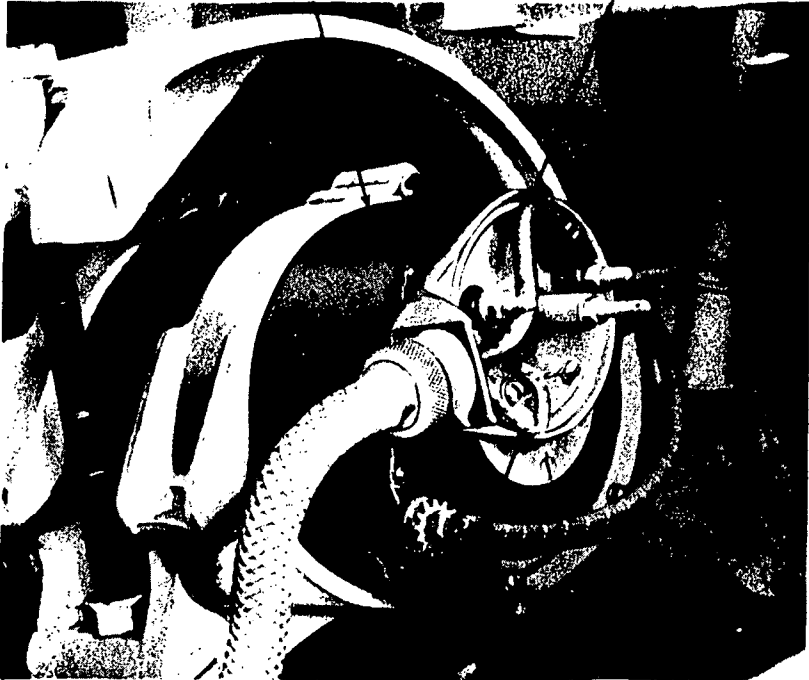

FIELD WIRE

GROUND WIRE

RA PD 329244

Figure 118—Generator Belt Adjustment and Generator Terminal Box (Later Vehicles)

(2) **INSTALLATION.** Install the generator on the mounting bracket or accessory drive housing. Install the generator terminal box, conduit and wires to the generator. Connect the field and armature leads to the generator, on later models connect the ground wire to the generator. Install the terminal box cover. On the later models, adjust the drive belt to one-half inch free play.

103. CIRCUIT BREAKERS.

a. **Description.** All circuits in the vehicle are protected by circuit breakers, thus eliminating fuses. On the early vehicles, the generator circuit breaker is located in the terminal box of each generator. On the later vehicles, a circuit breaker is located in the master switch box. The instrument panel has a number of circuit breaker buttons (figs. 101 and 102) which control the fuel cut-off circuit,

TANK, MEDIUM, M4A3

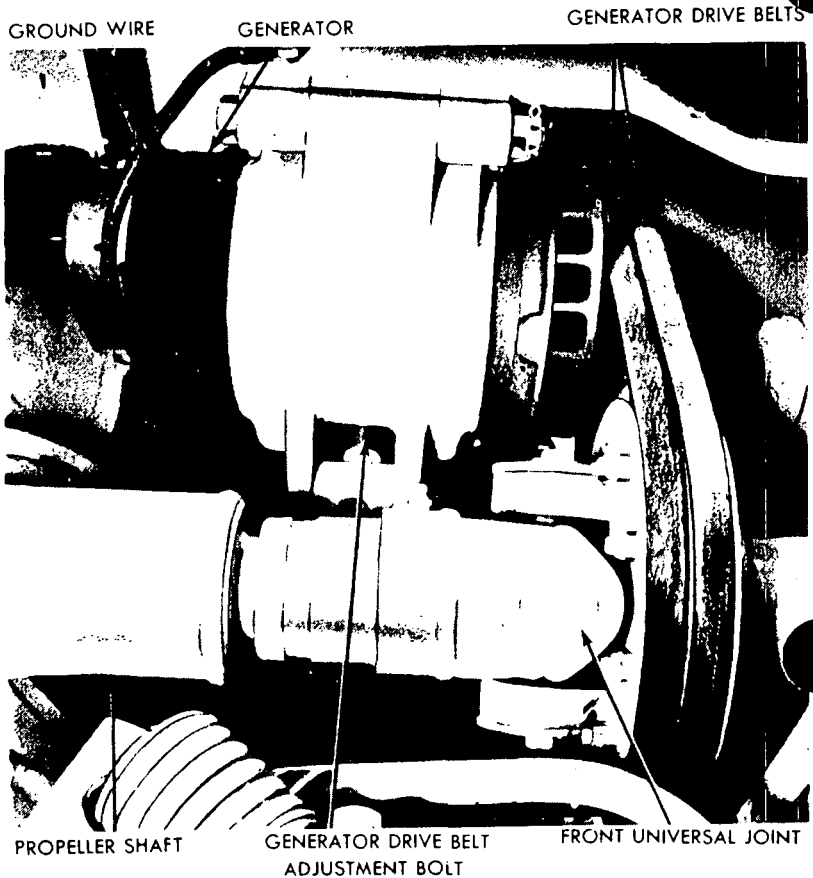

RA PD 329243

Figure 119—Generator and Drive Belts As Viewed From Escape Door in Hull Floor (Later Vehicles)

light circuit, accessory circuit, and instrument circuit. The turret circuit breakers are located in the turret switch box (figs. 105 through 108), and control the firing solenoids, compartment lights, utility plug, hydraulic pump motor, and radio circuit.

b. **Replacement.** The circuit breakers are accessible for replacement after the cover or panel on which they are mounted is removed.

104. GENERATOR REGULATOR.

a. **Description.** A generator regulator (M001-70-00061) is provided for each generator. The generator regulator (fig. 120) is

ELECTRICAL SYSTEM

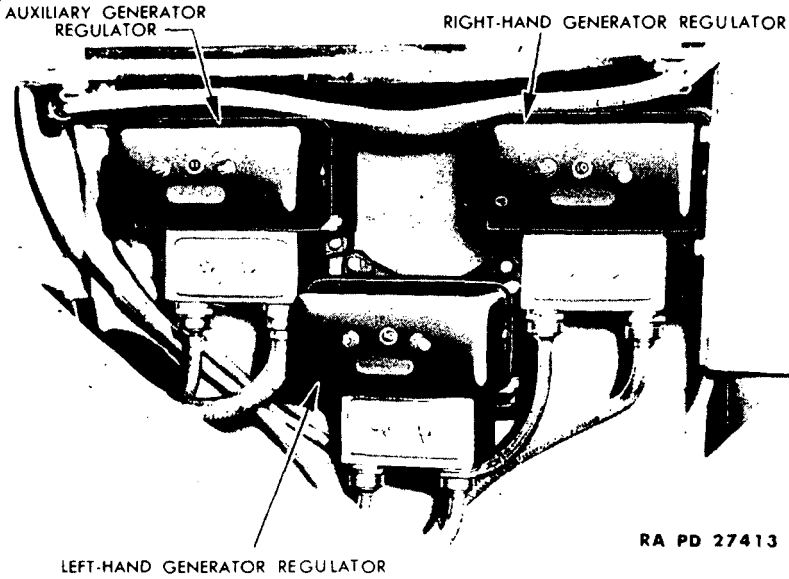

Figure 120—Generator Regulators (75-mm Dry Stowage Vehicles)

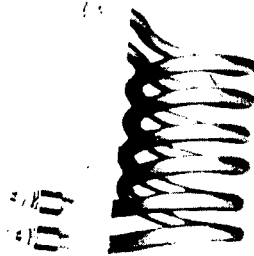

Figure 121—Battery Heater Unit

the three-unit type which includes a voltage regulator, current limiter, and a reverse-current relay or cut-out.

(1) The voltage regulator unit maintains the output of the generator at a constant predetermined voltage of 30 volts.

TANK, MEDIUM, M4A3

(2) The current limiter automatically varies the output of the generator in accordance with the state of charge of the battery and the amount of current being used throughout the vehicle. Thus the proper charge is delivered to the battery at all times without danger of overcharging. The current limiter unit limits the maximum current output of the generator to 50 amperes.

(3) The reverse current relay or cutout prevents the battery from discharging through the generator when the generator is at rest or when it is not developing its normal voltage.

(4) Vehicles of early manufacture were equipped with Autolite generator regulators marked "VAD4105A." When these become un-serviceable, they should be replaced with VAD4106B or VAD4106C. These two are equal electrically but VAD4106C is waterproof whereas VAD4106B is not.

b. Replacement. To remove the generator regulator, disconnect the battery ground cable at the battery. Disconnect all wires from the regulator terminals. Remove the conduit connection and wires from the regulator. Remove the four screws holding the regulator to the vehicle and remove the regulator. To install the regulator, fasten the regulator to the vehicle with the four screws. Install the conduit and wires to the regulator. Connect the wires to the terminals. Install the terminal box cover. Connect the battery ground cable.

105. CRANKING MOTOR.

a. Description. A 24-volt cranking motor (G104-17-91851) is mounted on the right-hand side of the flywheel housing. Its power is transmitted to the engine through an automatic drive. When the starter switch on the instrument panel is closed, a relay switch, located in the battery master switch box (figs. 115 and 122), closes the electrical circuit of the cranking motor. Rotation of the cranking motor shaft causes the pinion of the automatic drive to advance and mesh with the flywheel ring gear. After the engine starts and the flywheel speed exceeds that of the cranking motor, the pinion releases from the flywheel automatically. The cranking motor bearings do not require lubricating. A wiring diagram of the starting circuit is shown in figures 38 and 39.

b. Replacement. Turn off the battery master switch. Disconnect the cable from the cranking motor. Remove the engine compartment floor plate. Remove the two nuts and one bolt which hold the cranking motor to the crankcase flange and remove the cranking motor. To install the cranking motor to the crankcase flange, install the two nuts and one bolt to fasten the cranking motor to the crank-

ELECTRICAL SYSTEM

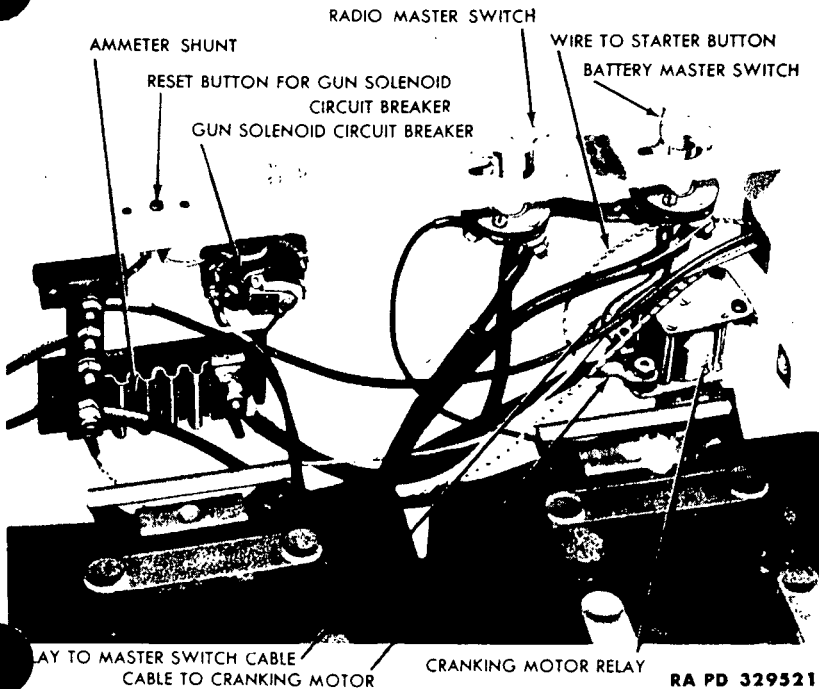

RA PD 329521

Figure 122—Cranking Motor Relay (Early Vehicles)

case flange. Connect the cable to the cranking motor. Install the engine compartment floor plate.

106. CRANKING MOTOR RELAY.

a. **Description.** The entire circuit from the battery to the cranking motor requires heavy cables, due to the large amount of current used. In order to avoid running the heavy cables to the instrument panel, a relay is installed in the cranking motor circuit. This relay closes manually when the starter switch on the instrument panel is closed. The cranking motor relay (figs. 115 and 122) is mounted in the battery master switch box.

b. **Replacement.** Disconnect the ground cable at the battery, remove the master switch box cover. Disconnect the cables and wires from the cranking motor relay. Remove the screws holding the relay to the master switch box and remove the relay. To install the cranking motor relay in the master switch box, connect the cables and wires to the relay in their proper places. Install the master switch box cover. Connect the ground cable to the battery.

TANK, MEDIUM, M4A3

107. HORN OR SIREN.

a. **Description.** A horn or siren is mounted on the left front side of the front slope of the hull (figs. 2 through 5), and is operated by a horn button mounted on the right-hand steering lever (fig. 7). In earlier models the button is operated by the left foot and is bracket mounted above the clutch pedal. The horn or siren circuit is shown in figures 47 and 49.

b. **Horn or Siren Button Replacement.** Turn off the battery master switch. Remove the four screws from the siren button cover and remove the cover. Remove the two screws holding the switch wires and bend the wires back. Remove the screw that holds the switch to the siren button housing and remove the switch. In earlier models, remove the two screws holding the switch to the bracket. To install horn or siren button, position the siren button switch in the switch housing and install the screw in the top of the switch. Connect the two wires to the switch and install the cover and four screws.

c. **Horn or Siren Replacement.** Disconnect the conduit coupling on the inside of the hull leading from the horn or siren, and remove the wire from the bullet connection. Remove the two cap screws that secure the horn or siren to the hull. Remove the conduit connection on the outside of the hull and lift off the horn or siren. To install, position the horn or siren to the hull with two cap screws. Insert the wire from the horn or siren through the coupling in the hull and fasten the coupling in the hull and fasten the coupling on the outside of the vehicle. Attach the bullet connection to the horn or siren wire on the inside of the hull. Fasten both ends of the bullet connection together and connect conduit couplings.

108. WINDSHIELD WIPER.

a. **Description.** The driver's compartment windshield wiper (fig. 123) is of the electric type, mounted on the windshield frame above the glass. It is turned on and off by the upper of the two toggle switches, located on the lower left-hand corner of the windshield frame. An extension from the windshield wiper motor, when plugged into a utility outlet on the instrument panel, furnishes the current.

b. **Replacement.** Unhook the wiper blade and remove the holding screw just above the wiper arm hinge. Pry the wiper arm off the shaft. Unscrew the nut on the center of the shaft and remove the nut and collar. Remove the nut from the upper shaft. Remove the rubber washer and the retainer. Remove the two bolts and nuts on each side of the wiper body on the inside of the frame. Disconnect the

ELECTRICAL SYSTEM

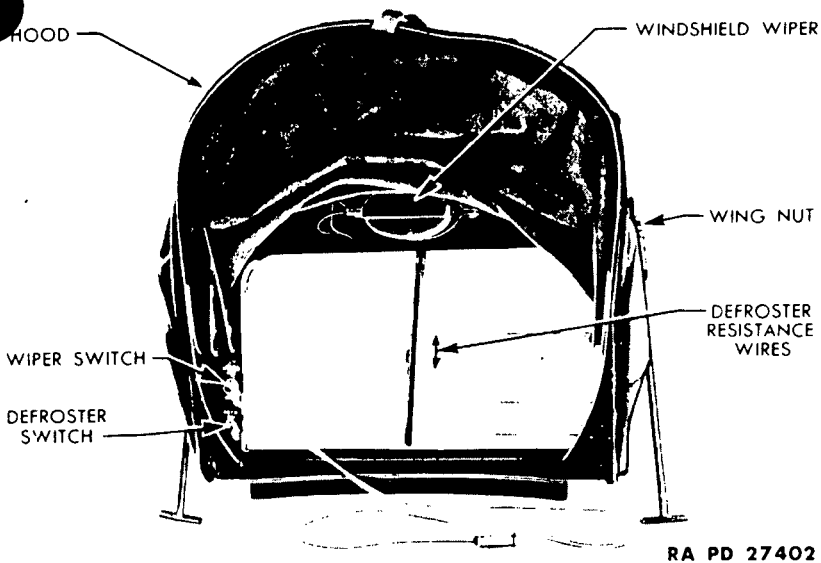

Figure 123—Windshield Wiper

Remove the screws from the wiper motor and remove the motor. To install the wiper motor in the frame, install the two bolts and nuts. Install the locking nut, rubber washer and retainer. Slide the wiper arm hinge on the end of the motor shaft and tighten the screw in the center of the hinge. Install the wiper blade.

109. DEFROSTER.

a. Description. The defroster is of the electric type, consisting of resistance wire placed between the double glass of the windshield. The defroster is turned on and off by one of the two toggle switches located either in the lower left-hand corner of the windshield frame, or above the windshield.

b. Replacement. Disconnect the two wires from the windshield wiper motor. Remove the screws from the front of the windshield frame and lift out the windshield glasses, defroster, and switches. Remove the defroster element. To install the defroster, place it between the windshield glasses. Install the assembly in the frame. Install the front frame and the screws. Connect the wires to the windshield wiper motor.

TANK, MEDIUM, M4A3

Section XXI

CLUTCH, PROPELLER SHAFTS, AND UNIVERSAL JOINTS**110. CLUTCH.**

a. **Description** (fig. 126). The clutch is of the double-disk type, and is composed of three major units—the pressure plate assembly, the center plate, and the two driven plates or disks. The two driven plates have friction facing riveted on each side. The release fork and the release levers are mounted on needle roller bearings. On the later model vehicles a clutch booster is provided to reduce the stiffness in the clutch pedal (figs. 124 and 125).

b. **Pedal Stroke Adjustment** (fig. 127). Set the pedal stroke adjusting stop screw so that the highest point of the clutch pedal pad is $15\frac{1}{4}$ inches (plus or minus $\frac{1}{8}$ in.) from the hull floor.

c. **Clutch Pedal Rod Adjustment** (fig. 127). Check the length of the rod running from the clutch pedal to the cross shaft dimension (A, fig. 127) and readjust its length if necessary. This rod should be $18\frac{3}{4}$ inches long, measured from the center of one clevis pin hole to the other. This measurement applies to wet stowage and 105-mm howitzer vehicles; on dry stowage 75-mm vehicles this rod should be $15\frac{1}{4}$ inches long. If this length is not held to the above measurements, the angle of the levers on the cross shaft will be changed, and this will affect the operation of the clutch pedal.

d. **Free Travel of Clutch Pedal Adjustment.** The free travel of the clutch pedal is determined by the clearance between the clutch release bearing and the clutch release fork. Clearance must exist between these parts at all times, otherwise, the clutch will slip and burn out. (Driving with the foot on the clutch pedal takes up this clearance with the same result.) As the clutch disk facings become worn, the pedal free travel decreases. If the vehicle is not equipped with a clutch booster and the free travel of the pedal drops to less than $2\frac{1}{2}$ inches measured at the pedal pad, it must be adjusted to 3 inches. If the vehicle is equipped with a clutch booster, the free travel of the pedal must be maintained at $2\frac{7}{8}$ inches at all times. The adjustment is made by lengthening or shortening the rod connecting the clutch cross shaft to the front end of this rod (fig. 127). Backing off the adjusting screw increases, and screwing in the adjusting screw decreases the free play of the pedal. If the correct free play cannot be obtained by this adjustment, the clutch plates are worn and must be replaced.

CLUTCH, PROPELLER SHAFTS, AND UNIVERSAL JOINTS

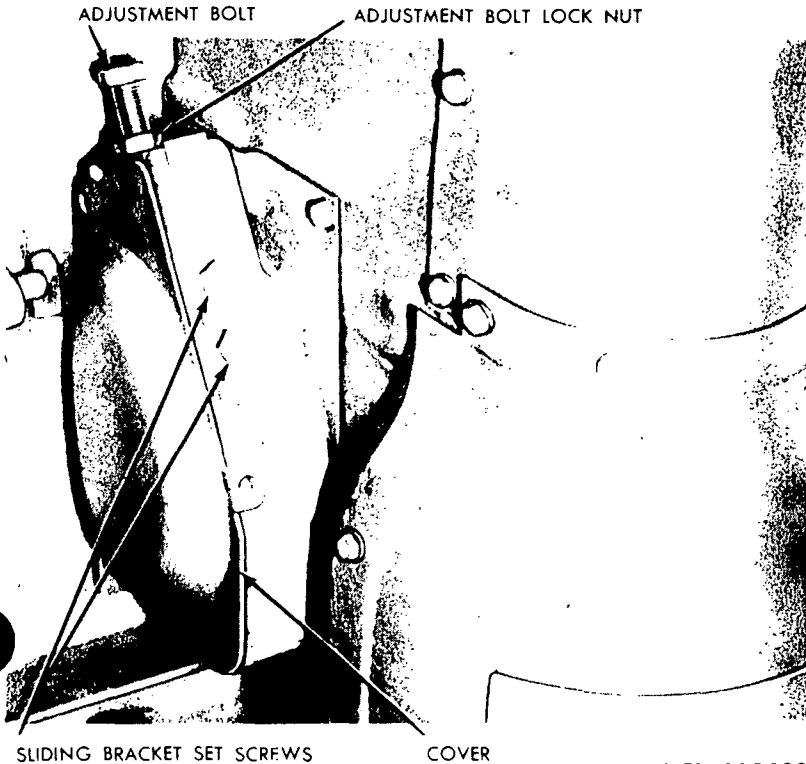

RA PD 329432

Figure 124—Clutch Booster (75-mm Dry Stowage Vehicles)

e. Adjustment If the Clutch Drags.

(1) **GENERAL.** If, after holding the pedal all the way down for a few seconds, the gears clash when shifting into first or reverse gear, the clutch is dragging. **NOTE:** *There is a tendency for the clutch driven shaft to turn over slowly when clutch is released. This is normal, and will not cause any noticeable clashing.* Check the pedal stroke adjustment (subpar. **b** above), and the free travel of pedal adjustment (subpar. **d** above). If these adjustments are satisfactory, check the adjustment of the three center drive plate travel limit screws (fig. 129).

(2) **PRELIMINARY STEPS.** Remove the inspection plate from the cover over the left side of the clutch housing (accessible from the fighting compartment). Make sure the engine ignition switch is off. Turn the engine until one of the center drive plate limit screws appears at the opening, as shown in figure 129.

TANK, MEDIUM, M4A3

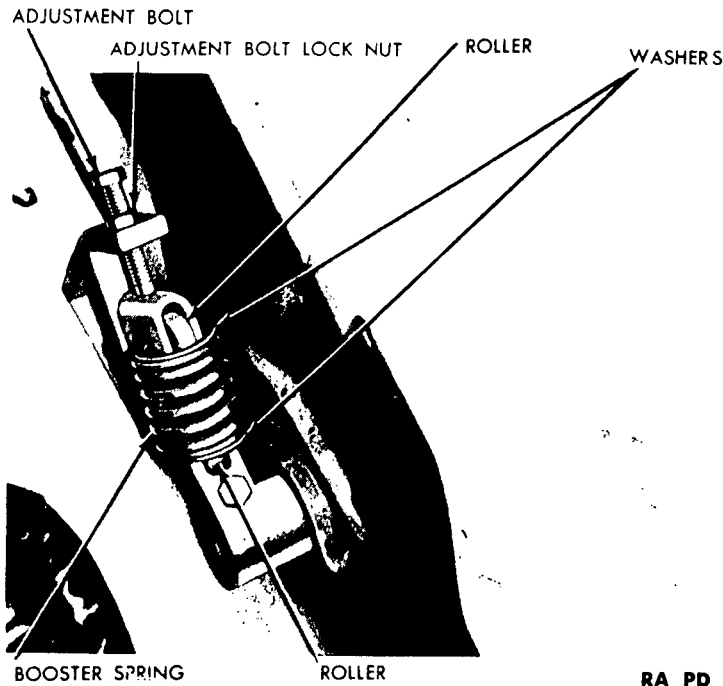

RA PD 329431

Figure 125—Clutch Booster (75-mm Wet Stowage, 76-mm, and 105-mm Howitzer Vehicles)

(3) **CENTER DRIVE PLATE TRAVEL LIMIT ADJUSTMENT** (fig. 129). With a screwdriver, turn the center drive plate travel limit adjusting screw in (clockwise) until it bottoms lightly, then turn it back four notches (counterclockwise). Repeat the above procedure for the two remaining adjusting screws. If this adjustment fails to correct the trouble, repeat the adjustment, backing off the screws five notches instead of four. If still unsatisfactory, it is probable that the center plate is binding on the flywheel drive lugs, the pilot bearing in the flywheel is binding, the clutch disk splined hubs are too tight on the clutch shaft, or that the driven plates are warped, any one of which will require the removal of the clutch (subpar. h below).

f. **Adjustment If the Pedal Pressure Is Too Stiff.** Check the length of the clutch pedal to clutch cross shaft rod (measuring from the center of one clevis hole to the other), and if incorrect, adjust to approximately 18³/₄ inches on wet stowage and 105-mm howitzer vehicles, and 15¹/₄ inches on 75-mm dry stowage vehicles. If vehicle is equipped with a clutch booster, replace the booster spring if it

CLUTCH, PROPELLER SHAFTS, AND UNIVERSAL JOINTS

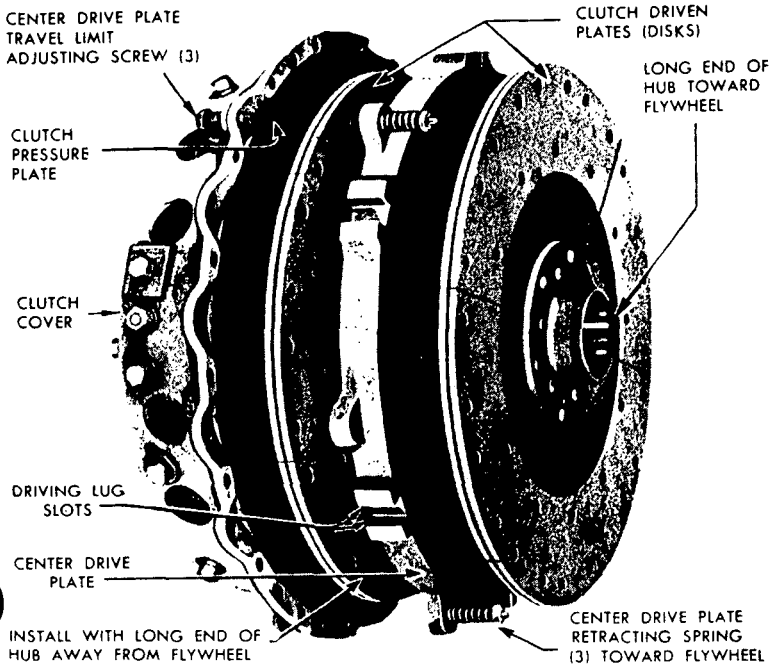

RA PD 330842

Figure 126—Clutch

broken or weak or adjust the booster (subpar. g below). Make sure that the linkage is not binding from lack of lubrication. Check the positions of the levers at inner or outer end of clutch cross shaft to make certain that they are not at too forward an angle. The index mark on the right end lever of the cross shaft should be vertical at the end of the clutch pedal free play. The other levers on the cross shaft will be vertical in this pedal position.

g. Clutch Booster Replacement.

(1) **REMOVAL.** Boosters equipped with covers have the sliding bracket set screws on top of the booster frame (fig. 124), boosters without covers will have the sliding bracket below the frame (fig. 125). Remove the two screws that secure the cover to the frame and remove the cover. Loosen the two cap screws that hold the adjustable bracket to the booster frame. Loosen the adjustment bolt lock nut. Back off the adjustment bolt until the spring is in a released position. Remove the booster spring and washers.

TANK, MEDIUM, M4A3

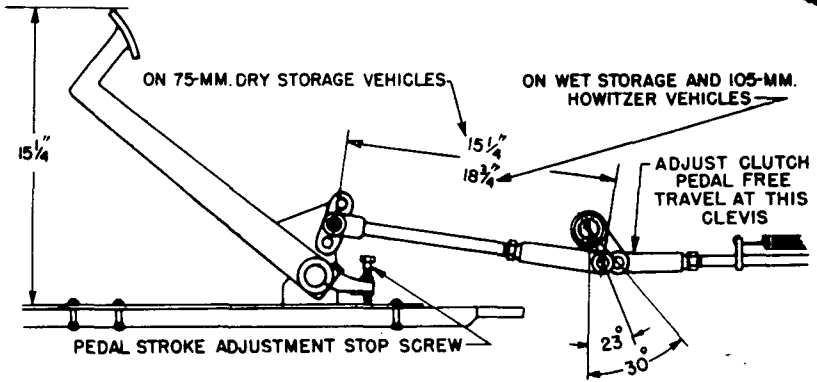

RA PD 329522

Figure 127—Clutch Pedal Linkage

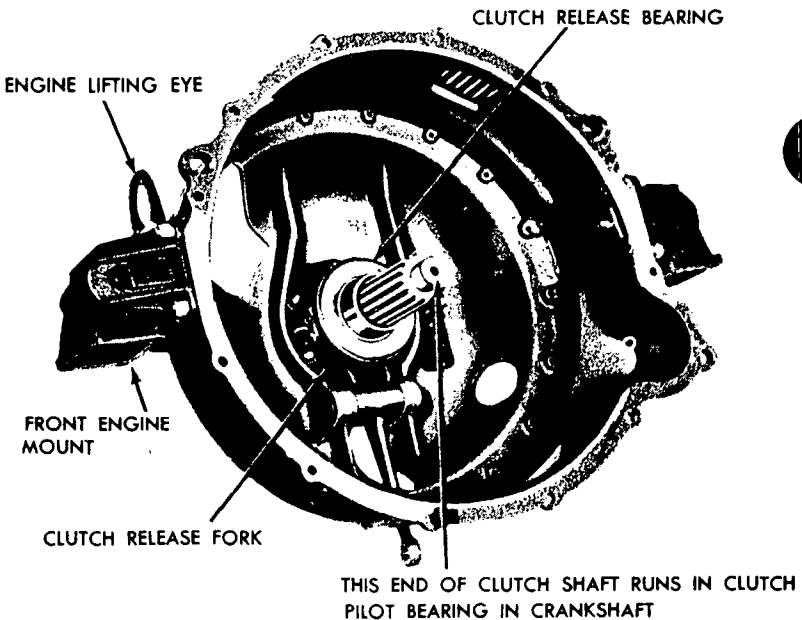

RA PD 329523

Figure 128—Clutch Housing

(2) **INSTALLATION.** Place the booster spring in position between the two rollers. Slide a washer between each roller and the booster spring. Turn the adjusting bolt clockwise until 3/4 of the adjusting bolt is entered into the frame. Tighten the adjustment bolt lock

CLUTCH, PROPELLER SHAFTS, AND UNIVERSAL JOINTS

Loosen the two bracket screws. Hold the cover in place and install the two screws.

h. Clutch Replacement.

(1) **REMOVAL.** Remove the engine as outlined in paragraph 63. Place the engine on a stand so that the front end will be supported after the clutch housing is removed. Remove the cranking motor. Remove the clutch housing (fig. 128) by removing the 12 flange nuts. To hold the clutch springs compressed while the clutch pressure plate is removed, use six $\frac{3}{8}$ -inch, 16-thread $1\frac{1}{2}$ -inch long cap screws, screwing them into the holes in the pressure plate assembly until the heads just bottom (fig. 130). Install the clutch pilot tool (41-T-3083-75) to keep the clutch disk splines in alignment, and also to prevent the clutch disks from falling. Remove the lock wire from the 18 cap screws holding the pressure plate to the flywheel, and remove the cap screws and pressure plate. Remove the center drive plate from the driving lugs in the flywheel.

(2) INSTALLATION.

(a) **Preliminary Steps.** See that the friction surface of the flywheel is smooth and clean. Any deposits on the friction surface must be sanded down, and the surface cleaned with dry-cleaning solvent. If the clutch shaft pilot bearing is in good condition, repack it with a high-melting point grease.

(b) **Install Clutch Disks and Center Drive Plate.** Place one driven member (disk) in place with the long end of the hub toward the flywheel (fig. 126). Insert the center drive plate with the retractor spring (fig. 126) toward the flywheel, making sure the driving lug slots fit freely on the driving lugs in the flywheel. Install the center drive plate on the flywheel lugs. This will place the retractor springs in line with the three openings in the flywheel nearest the three dowel pins in the flywheel rim, and bring the springs in line with the three adjusting screws in the pressure plate assembly. Using the clutch pilot tool (41-T-3083-75) (fig. 130), slip it through the splined hub of the disk and into the clutch shaft pilot bearing. Remove the handle from the pilot tool. Slip the second disk on the pilot with the long end of its hub away from the flywheel. This aligns both driven members with each other and with the clutch shaft pilot bearing, while the pressure plate assembly is being attached.

(c) **Install the Clutch Pressure Plate.** Install the clutch pressure plate assembly so that the dowel holes line up, and install the 18 cap

TANK, MEDIUM, M4A3

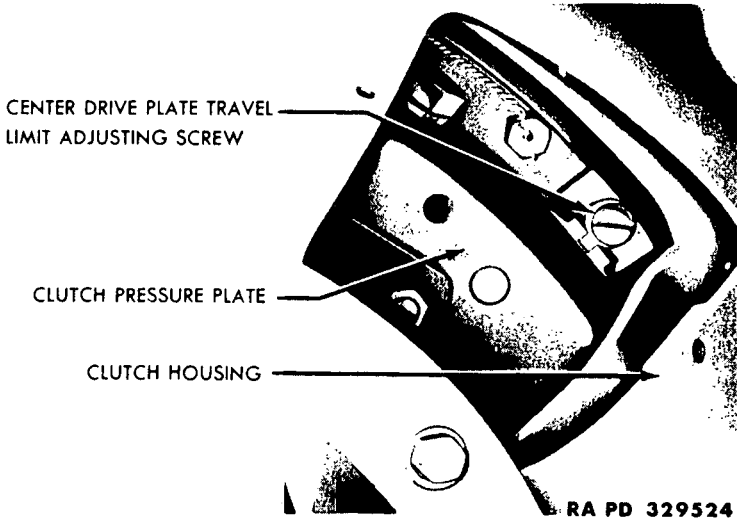

Figure 129—Inspection Plate Removed From Left Side of Clutch Housing

screws which hold it to the flywheel. Wire the cap screws to prevent loosening. Start the wire at the cap screw nearest the clutch center drive plate travel limit adjusting screw, and lock it with the next nearest cap screw. Proceed with the next two until they all have been locked together in pairs. Remove the six $\frac{3}{8}$ -inch cap screws used to hold the pressure plate compressed (fig. 130).

(d) *Adjust Center Drive Plate Travel Limit.* Adjust the three center drive plate travel limit adjusting screws (fig. 129) with a screwdriver by turning clockwise until they bottom lightly, then turn back four notches.

(e) *Install Clutch Housing.* Remove the clutch pilot tool. Install the clutch housing. Install the cranking motor. Install the engine in the vehicle (par. 64).

i. Clutch Release Bearing or Fork Replacement (fig. 128).

(1) **REMOVAL.** Remove the engine (par. 63). Remove the clutch housing (subpar. h above). Disconnect the two springs which hold the release bearing and fork in contact. Slide the release bearing

CLUTCH, PROPELLER SHAFTS, AND UNIVERSAL JOINTS

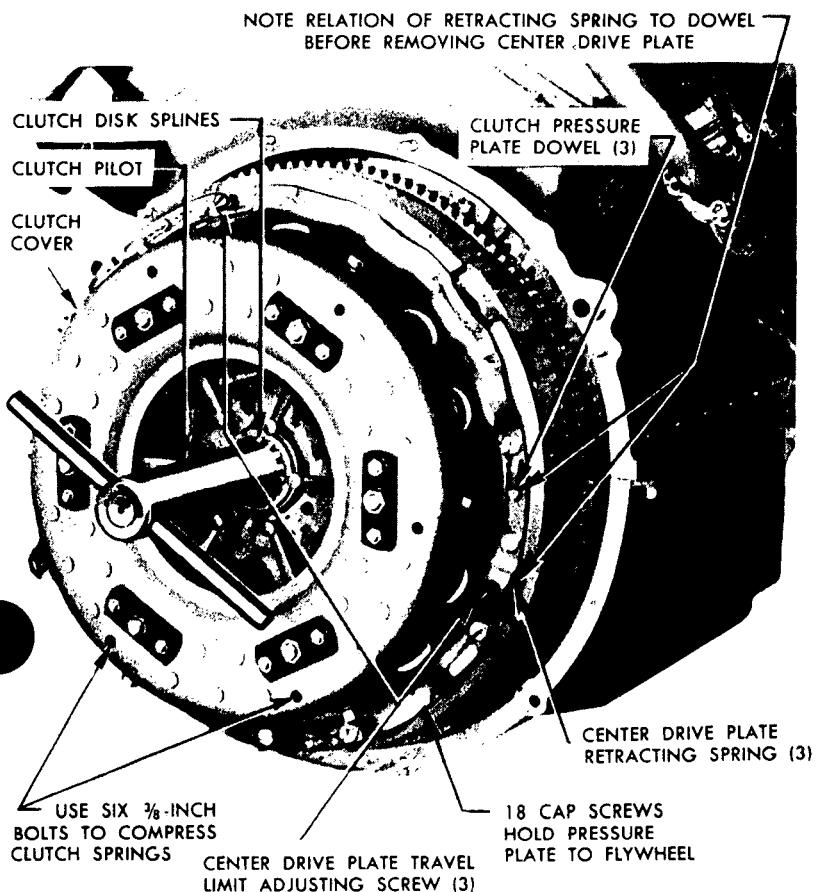

RA PD 330850

Figure 130—Clutch With Clutch Housing Removed

off the hub. To remove the clutch fork, remove one lock ring on either end of the shaft running through the clutch fork, and slide the shaft out of the housing. Remove the fork from the housing.

(2) **INSTALLATION** (fig. 128). Place the clutch release fork in the housing, and insert the clutch release shaft through the needle roller bearings and fork. Place the snap ring retainer in the housing at each end of the shaft. Slip the hub and bearing assembly over the hub of the bearing retainer, and hook the two springs to the clutch release fork and the hub of the release bearing.

TANK, MEDIUM, M4A3

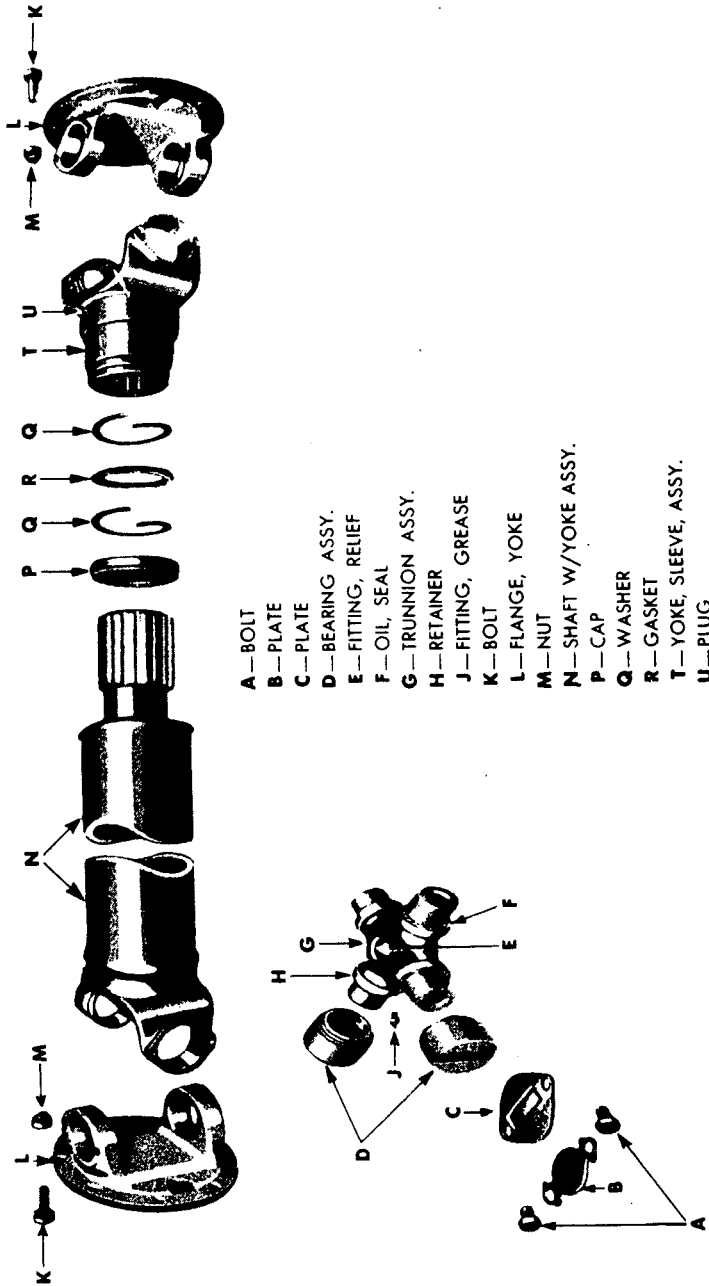

- A—BOLT
- B—PLATE
- C—PLATE
- D—BEARING ASSY.
- E—FITTING, RELIEF
- F—OIL, SEAL
- G—TRUNNION ASSY.
- H—RETAINER
- J—FITTING, GREASE
- K—BOLT
- L—FLANGE, YOKE
- M—NUT
- N—SHAFT W/YOKE ASSY.
- P—CAP
- Q—WASHER
- R—GASKET
- T—YOKE, SLEEVE, ASSY.
- U—PLUG

RA PD 27511

Figure 131—Propeller Shaft

CLUTCH, PROPELLER SHAFTS, AND UNIVERSAL JOINTS**PROPELLER SHAFTS AND UNIVERSAL JOINTS.****a. Propeller Shafts.**

(1) **DESCRIPTION** (fig. 131). The propeller shaft transmits power from the engine in the rear of the vehicle to the transmission at the front of the vehicle.

(2) **REMOVAL.** Remove the engine from the vehicle (par. 63). Remove the escape hatch from the floor plate. If working on a 75-mm dry stowage vehicle remove the eight cap screws and front universal joint. Working through the opening in the floor plate, unscrew the grease seal retainer at the front universal slip joint (fig. 131). Pull the propeller shaft to the rear out of the "tunnel" (the front end of the shaft will pull out of the slip joint in the front universal joint, leaving the front universal on the transmission). If working on wet stowage or 105-mm vehicles, loosen the generator belt adjustment (par. 102 b). Remove the nuts from the front universal, and remove the universal.

(3) **INSTALLATION.** Remove the front universal from the propeller shaft, and install it on the transmission. Slip the propeller shaft in between the ammunition racks, and connect the front universal joint to the propeller shaft at the splined slip joint. Arrow marks are placed on both the front and rear universal joints, and on the propeller shaft. These arrows must be lined up before assembly of the universal joint to the propeller shaft. This is to establish that the front and rear universal joint yokes are in alignment to prevent propeller shaft vibration. Screw the grease seal retainer cap (fig. 131) on the front universal joint, making sure that the cork ring and the snap ring washers are not damaged. If working on a 75-mm dry stowage vehicle, install the front universal joint cover. If working on wet stowage or 105-mm howitzer vehicles, adjust the generator belts (par. 102 b). Reinstall the engine (par. 64), and bolt the rear universal joint to the clutch flange. Depress the clutch, and turn the propeller shaft to install all the bolts.

b. Propeller Shaft Universal Joints.

(1) **DESCRIPTION.** Two universal joints are used with the propeller shaft, one at each end. The front one is connected to the shaft through a splined slip joint. The yoke for the rear universal joint is

TANK, MEDIUM, M4A3

part of the shaft. Four needle roller bearings are used in each universal joint. The bearings and the seals in the universal joints are the parts most likely to wear out. Excessive bearing wear is indicated by propeller shaft vibration. When vibration develops, notify higher authority before the universal joints require replacement. Universal joint bearings can be replaced by ordnance maintenance personnel without removing the universal joints, if the need is detected in time, thus saving the removal of the engine.

(2) PROPELLER SHAFT UNIVERSAL JOINT BEARING REPLACEMENT.

(a) *Removal* (fig. 131). To remove the bearings in the propeller shaft universal joint front or rear, remove the escape hatch at the forward end of the hull floor, if working on wet stowage or 105-mm howitzer vehicles. (This is necessary in order to work on the forward universal joint.) If working on a 75-mm dry stowage vehicle, remove the universal joint covers. Hold the clutch pedal down, and have the transmission in neutral to free the propeller shaft, turn the shaft until the universal joint lubrication fitting is accessible. Remove the fitting. Remove the universal joint bearing cover plate by bending down the locking ears and removing the bolts. Hold down the clutch pedal, and turn the propeller shaft one-half turn. Remove the opposite bearing cover which now faces up. Using a brass or copper drift, tap the bearing down until the trunnion forces the bottom bearing to drop out. Hold the clutch pedal down, and turn propeller shaft one-half turn. Drive the universal joint trunnion down, using a brass or copper drift, until the other bearing is forced out of the yoke. Follow the same procedure to remove the other two bearings.

(b) *Installation*. Examine the cork seal and retainer of each bearing, and replace it if necessary. Place the trunnion in the yoke, and push it through the yoke so that the bearing can be set in place on the trunnion, then drive the bearing lightly into the yoke on the propeller shaft until the bearing is flush. Assemble the cover plate to the slot in the bearing, and line up the bolt holes in the cover with the holes in the yoke. Install the two cap screws and lock plate. Turn the universal joint, and enter the opposite bearing on the trunnion. Drive the bearing lightly into the yoke. Line up the slot in the bearing and the cover, and install the cover. Bend up one ear of the

CLUTCH, PROPELLER SHAFTS, AND UNIVERSAL JOINTS

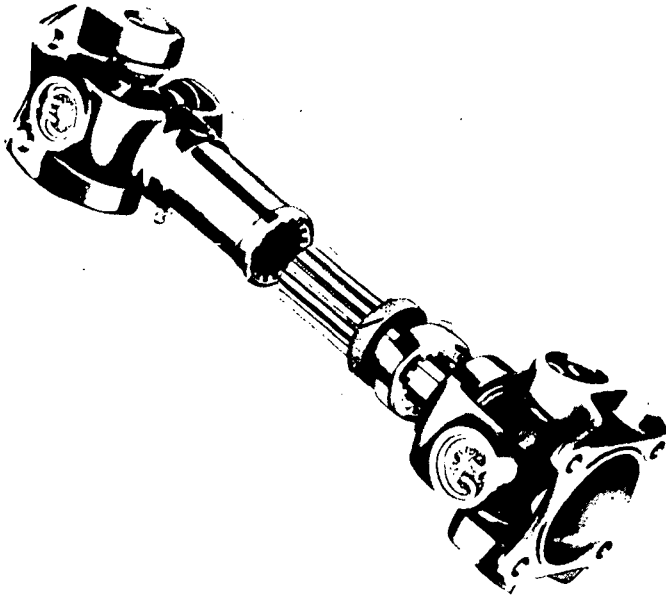

RA PD 329526

Figure 132—Accessory Drive Shaft

plate against each of the cap screw heads (at each plate). Repeat the procedure for the other two bearings. If working on a 75-mm dry storage vehicle, install the universal joint covers.

112. ACCESSORY DRIVE SHAFTS AND UNIVERSAL JOINTS.

a. **Accessory Drive Shafts** (fig. 132). The accessory drive shafts provide a connection between the driving flange on the accessory gear assembly at the rear of the engine and the flange on the accessory drive housing, one on each side of the engine. To remove the shaft, remove the four bolts from each flange.

b. **Accessory Shaft Universal Joint** (fig. 132). Two universal joints are used on each shaft, one at each end. Four needle roller bearings are provided in each universal joint. Accessory drive shafts are supplied as an assembly with the universals in place.

c. **Replacement.** Disconnect the accessory drive shaft at the accessory drive housing. Disconnect the shaft at the engine and remove the accessory shaft. To install the accessory shaft, connect the shaft to the engine and then to the accessory drive housing.

TANK, MEDIUM, M4A3

Section XXII
POWER TRAIN ASSEMBLY

113. DESCRIPTION.

a. **Power Train** (fig. 133). The power train assembly consists of the transmission, differential, and final drives.

b. **Transmission** (fig. 133). The transmission has five forward speeds and one reverse speed. The second, third, fourth, and fifth gears are synchronized. The first and reverse gears are in constant mesh, and are engaged by a sliding clutch.

c. **Final Drive Assembly** (fig. 133). There are two basic designs of final drive housings; namely, the three-piece and one-piece types, both of which are built with either the single-anchor or the double-anchor brake. The new one-piece final drive housing with sharp contour is made only with the double-anchor brake. This makes a total of five different brake final drive combinations, all of which are interchangeable as complete units; that is, a one-piece final drive assembly may be installed in place of a three-piece unit, and a final drive assembly equipped with double-anchor brakes may be installed in place of one equipped with single-anchor brakes, provided the proper lever and linkage system is used. Before attempting to install a different type final drive assembly from the one with which the vehicle originally equipped, pertinent TM's and SNL's should be consulted to determine whether any change in the linkage is required. Steering levers (figs. 135 and 137), with lugs both at front and rear on lower end for attaching control rods, may be used with either single- or double-anchor brakes. To avoid confusion, a final drive assembly, with the same type brake and linkage system as that originally installed in the vehicle, should be used whenever possible.

d. **Final Drive Assembly Lubrication Oil Cooler**. Oil flows from the differential through a tube to the sump in the bottom of the transmission housing, where it is drawn into the pump and forced out the left side of the transmission through a tube to the oil cooler assembly located on the fighting compartment side of the bulkhead. The oil enters at the bottom of the cooler, flows upward through a by-pass tube to the outlet connection at the top of the cooler, and returns through a tube to the final drive assembly. When the oil reaches a temperature of 100°F, the by-pass valve closes, causing the oil to flow upward through the oil cooler tubes. Air drawn through the cooler by the engine fans reduces the temperature of the oil, then it is returned to the final drive assembly to lubricate the gears in the transmission, differential, and final reduction assemblies.

e. **Final Drive Assembly Serial Number**. The serial number of the final drive assembly is stamped on a plate mounted on the differential case directly over the transmission.

POWER TRAIN ASSEMBLY

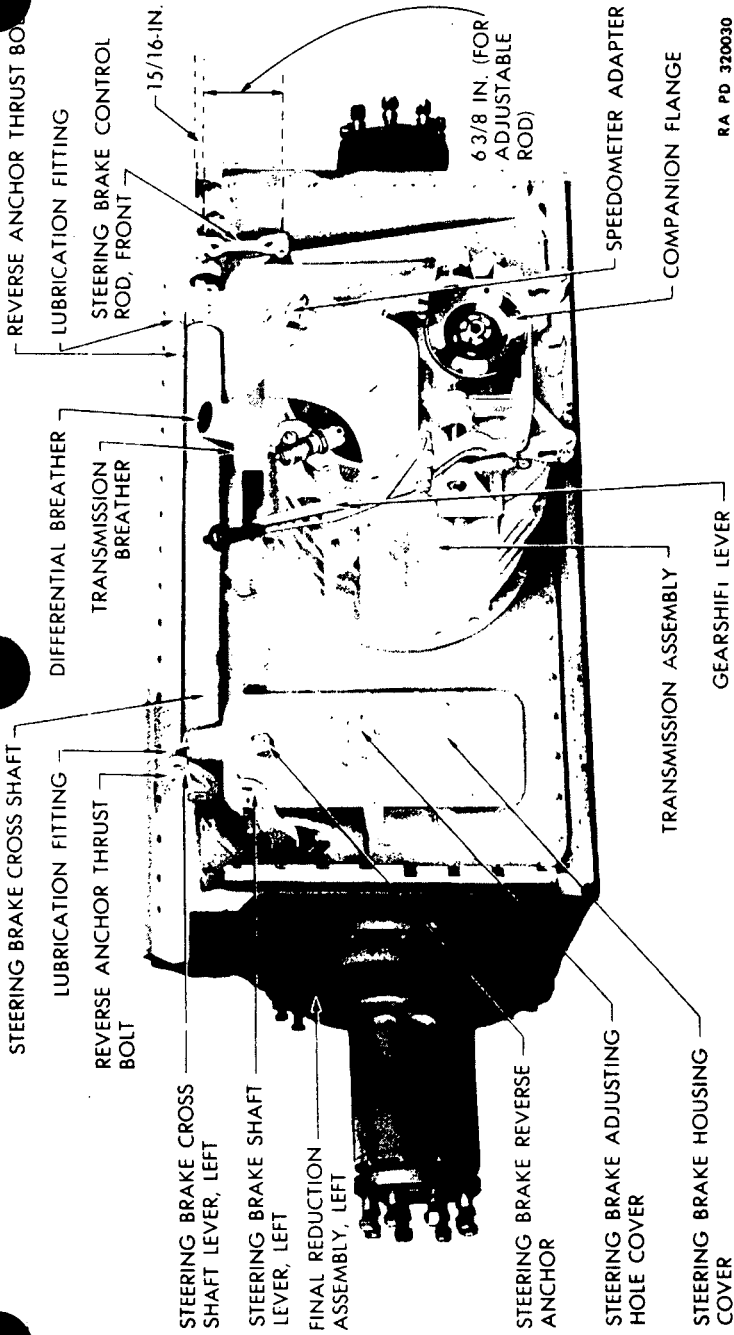

RA PD 320030

Figure 133—Typical Power Train Assembly

TANK, MEDIUM, M4A3

GEARSHIFT LEVER

LUBRICATION FITTING

GEARSHIFT LEVER SHAFT

FULCRUM YOKE

1—INSTALL GEARSHIFT LEVER SHAFT

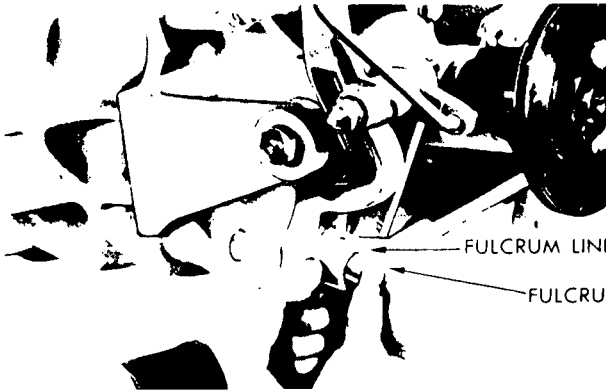

FULCRUM LINK

FULCRUM LINK BOLT

2—INSTALL FULCRUM LINK BOLT

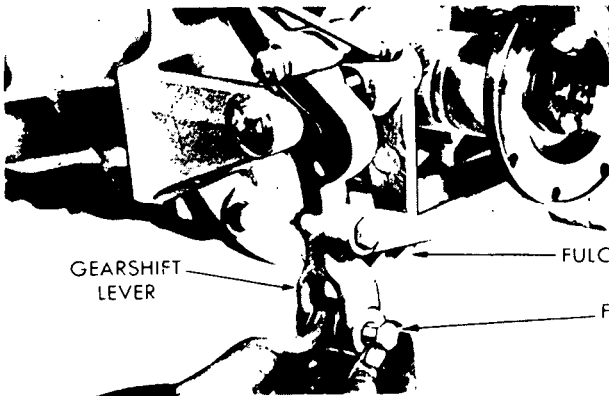

GEARSHIFT LEVER

FULCRUM YOKE

FULCRUM BOLT

3—INSTALL FULCRUM BOLT

RA PD 312480

Figure 134—Gearshift Lever Installation

POWER TRAIN ASSEMBLY**114. GEARSHIFT LEVER REPLACEMENT.**

a. Remove the gearshift lever yoke bolt, fulcrum link bolt, and the lever shaft, then lift off the gearshift lever (fig. 134). To install the gearshift lever wipe the surface of the shaft clean and cover the bearing surfaces, bolts, and shafts with engine oil. Position lever on left side of the transmission, install gearshift lever shaft, fulcrum link bolt, and fulcrum yoke bolt. Push the shaft in, and screw the nut on inner end of the shaft. Apply lubricant gun to lubricating fitting, and move gearshift lever back and forth while forcing the lubricant into the fitting. Tighten the nuts so that the linkage moves freely without excessive play, and install the cotter pins.

115. STEERING BRAKE SHOES.

a. **General.** There are two basic designs of steering brakes used on medium tanks of the M4A3 series, namely the single- and double-anchor types.

b. Single-anchor Type.

(1) **DESCRIPTION.** The single-anchor brake is a three-shoe, external contracting, differential steering brake operating in oil (fig. 142). The brake actuating shaft serves the dual purpose of tightening shoes on the drum for the application of the brake, and as an anchor for the shoes to take the torque reaction of the system. The single-anchor brake can be readily identified by the adjusting hole screw plugs near the top center of each brake drum housing cover as shown in figure 142. Note that the brake control rods are attached to the rear lug at the lower end of the steering levers and that, as the steering levers are pulled back, the control rods and brake actuating shaft levers are pulled downward.

(2) REMOVAL.

(a) *Drain Oil From the Steering Brake Housings.* The drain plugs (G-103-05-01680) are located at the bottom of the right and left final drive housings accessible from the front of the vehicle.

(b) *Disconnect Steering Rod From Brake Shaft Arm.* Remove the cotter pin from the clevis pin, and remove clevis pin connecting steering rod and brake shaft arm.

(c) *Remove Inspection Plate.* Take out bolts holding inspection plate to steering brake housing and remove the plate.

(d) *Remove Brake Shoes.* Back the center adjustment beneath shoes all the way off. Remove the cotter pin that passes through the center lobe of the cam and link pin. Remove the brake adjusting nut, push rod forward through cam and remove washer and spring. Forward end of brake shoes will now be free. Insert screwdriver into

TANK, MEDIUM, M4A3

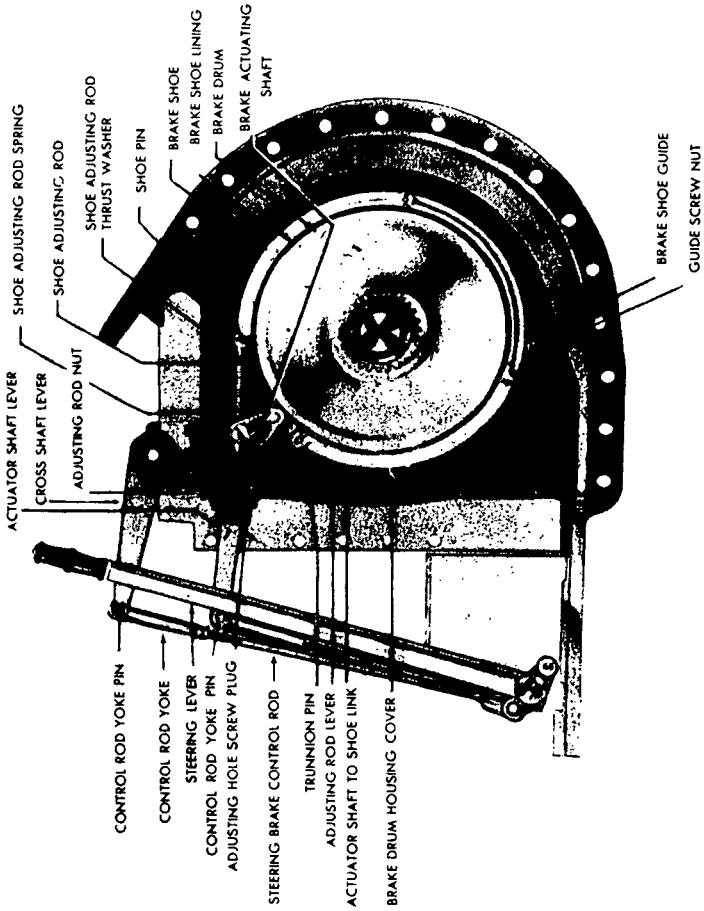

RA PD 336226

Figure 135—Cross-sectional View of Steering Brake Mechanism

POWER TRAIN ASSEMBLY

Annular groove in inside end of pin connecting lower end of cam and link, pry with screwdriver and slide pin out of inside end of cam. Brake shoes are now free, and can be pulled out of housing from beneath brake drum. Attach long heavy wire to the brake shoes, then pull the brake shoes beneath the drum, allowing the wire to follow around the drum. It may be necessary to use a 4- or 5-foot bar to lift shoes over centering bolt. Repeat process to remove shoes in other housing.

(3) INSTALLATION.

(a) *Install Brake Shoe Assembly.* Check to see that the centering adjustment is in place in steering brake housing, and if not, install the centering bolt and nut. Attach a heavy wire to the rod end of the brake shoe assembly. Pull the brake shoe around the brake drum. Lift link end of shoe assembly into place, engage link and cam and slip pin connecting link and cam into place from inside of cam, being sure that end of pin with annular groove is on inside. Turn pin to align cotter pin holes in pin and cam, insert cotter pin and split ends of pin. Reach over drum, slide spring and washer onto rod, slide rod through pin in upper end of brake cam and screw brake adjusting nut on rod. Adjust centering bolt to give 0.005-inch clearance between bottom of drum and brake lining. Adjust brake adjusting nut to give clearance of $3\frac{5}{16}$ inches between rear surface of upper pin and face of inspection hole with rear end of brake arm at top of its travel. The brake arm should be set on serrated brake shaft to give a distance of $\frac{7}{8}$ inch from top rear end of arm to level of top of brake housing.

(b) *Install Inspection Plate.* Inspect to see that gasket is in good condition and if not, replace. Hold a new gasket and inspection plate into place and fasten with bolts.

(c) *Connect Steering Rod and Brake Shaft Arm.* Align holes in brake shaft arm and steering rod, insert clevis pin and secure in place with cotter pin.

(d) *Replace Oil in Housings.* Follow directions on lubrication in paragraph 29 d (9).

(e) *Adjust Steering Brake Nut.* Adjust steering brake nut without removing inspection plate as outlined in paragraph 116 b.

c. Double-anchor Type.

(1) **DESCRIPTION.** The double-anchor brake is a three-shoe, external contracting, differential steering brake operating in oil (figs. 136 and 137). Two fixed anchors transfer the brake torque reaction directly to the brake housing instead of to the brake operating lever system as on the single-anchor brake. As a result, the self-energizing effect reduces the hand effort necessary for a given turn. The double-anchor brake can be readily identified by the reverse anchor adjusting

TANK, MEDIUM, M4A3

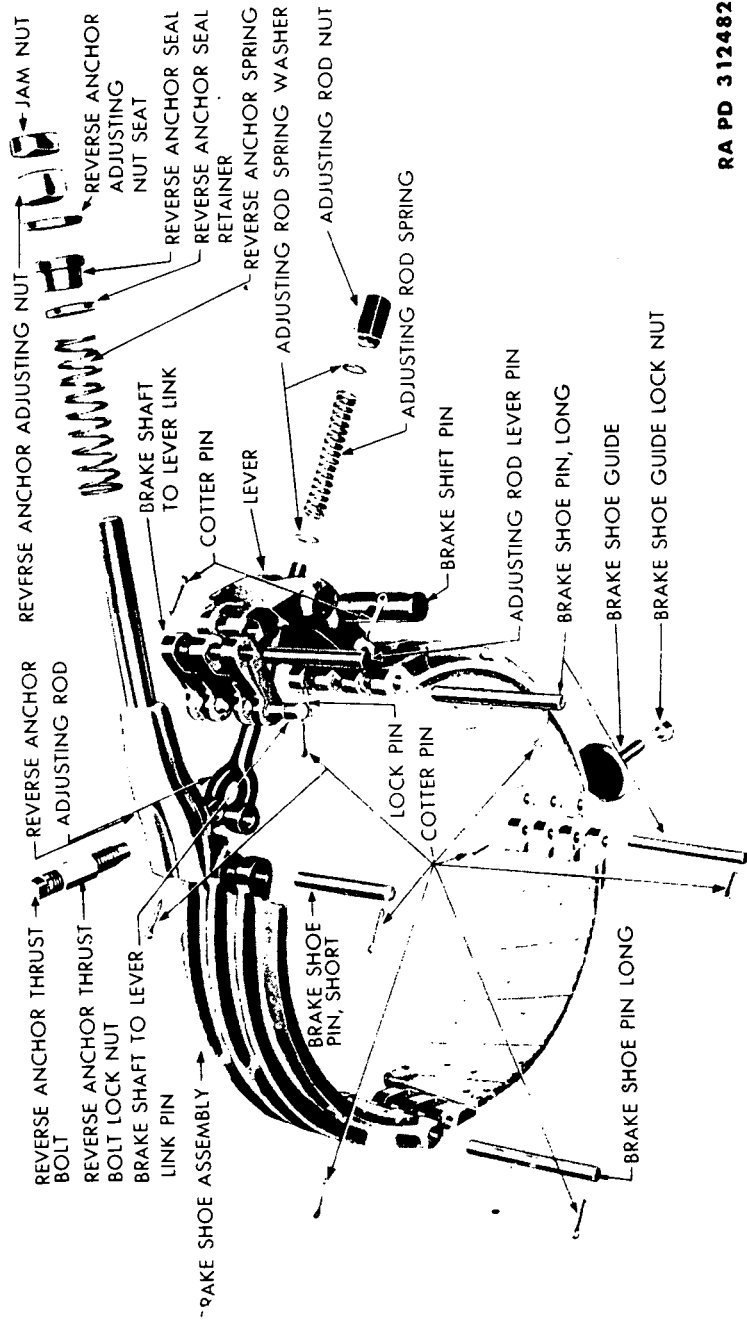

RA PD 312482

Figure 136—Steering Brake Shoe Assembled (Double-anchor Type)

POWER TRAIN ASSEMBLY

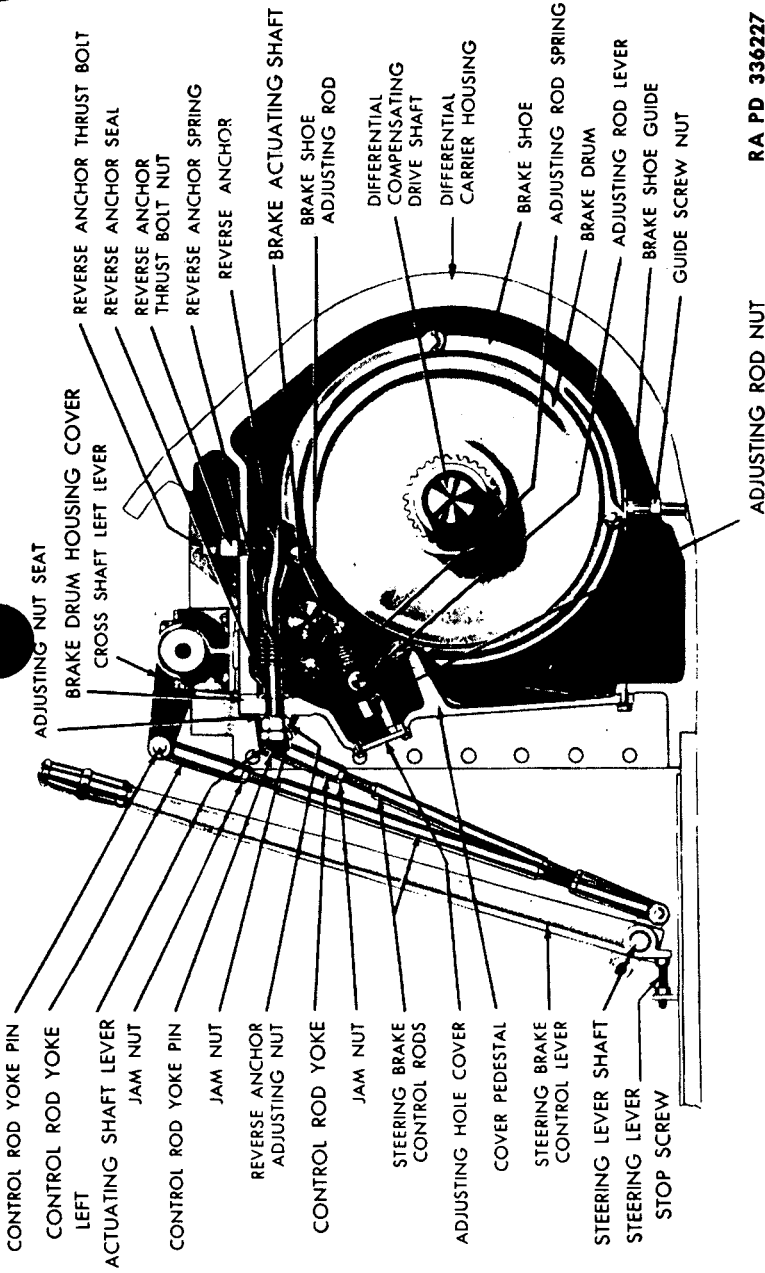

Figure 137—Cross-sectional View of Double-anchor Steering Brake Mechanism

RA PD 336227

ADJUSTING ROD NUT

TANK, MEDIUM, M4A3

nut near the top center of each brake drum housing cover, as shown in figure 136. Note that the brake control rods are heavier than on the single-anchor brake and are attached to the front lug at the lower end of the steering levers. The control rods and brake actuating shaft levers are pushed upward instead of being pulled downward, as on the single-anchor brake.

(2) REMOVAL.

(a) *Drain Final Drive Housing.* Remove the two plugs on the bottom of the final drive housing, and drain out the lubricant.

(b) *Disconnect Steering Brake Linkage.* Remove the two clevis pins at the top of the steering brake control rods.

(c) *Remove Reverse Anchor Jam Nut, Adjusting Nut, and Housing Cover* (figs. 136 and 137). Remove the lock wire and unscrew the jam nut, adjusting nut, and adjusting nut seat from the reverse anchor rod. Remove the steering brake housing cover attaching cap screws, and lift off the cover.

(d) *Remove Reverse Anchor Spring and Seal* (figs. 136 and 137). Loosen the reverse anchor thrust bolt lock nut, loosen the thrust bolt, and lift out the rod.

(e) *Lower Brake Shoe Guide* (fig. 136). Reach through the opening in the brake housing below the shoe, and loosen the guide shoe lock nut (located directly below center of shoe). Screw the guide screw down into the bottom of the housing.

(f) *Disconnect Shoe Adjusting Linkage* (fig. 136). Unscrew the nut from the adjusting rod, and remove the adjusting clip. Push the rod back until free of the lever. Lift out the spring and washers, and allow the shoe and lever to fall forward. Remove the brake shaft swivel pin from the lever.

(g) *Remove Steering Brake Shoe Adjusting Lever* (fig. 137). Remove the cotter pin and the hinge pin between shoe and lever. Rotate the brake shaft lever upward, and swing the lower end of the brake shoe lever in toward the brake drum to allow the upper hinge pin to clear the brake drum housing. Remove the cotter pin, and pull out the hinge pin at the top of adjusting lever. Remove the lever.

(h) *Remove Steering Brake Shaft Lever and Brake Shoes* (figs. 136 and 137). Unscrew the steering brake lever clamp screw and remove it. Punch-mark the lever and the shaft for proper assembly. Drive the lever off the shaft. Remove the three cap screws which attach the brake shaft bearing plate to the housing, and pull out the plate and shaft until inner end of the shaft clears the inner bearing. Tilt the inner end of the steering brake shaft upward to allow the bearing plate to pass the final drive carrier plate nuts. Hold the

POWER TRAIN ASSEMBLY

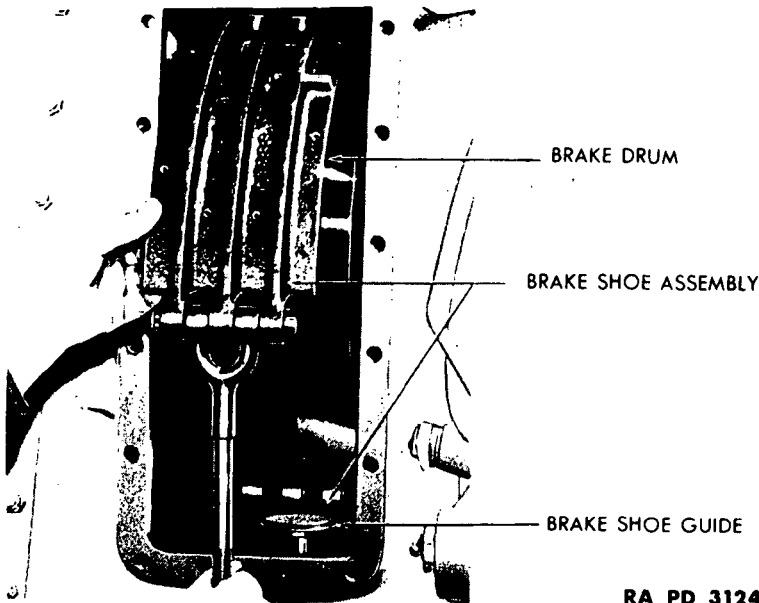

RA PD 312484

Figure 138—Installing Brake Shoe in Housing (Double-anchor Type)

bearing plate against the final drive housing flange, and move the shaft back into the inner bearing. Lift out the bearing plate. Rotate the shaft, and pull the shaft out of the inner bearing. Drop the inner end of the shaft, and remove the shaft and the link through the large opening. Pull the brake shoes and adjusting rod assembly from the housing over the top of the brake drum.

(3) INSTALLATION.

(a) Locate Brake Shoe Guide (figs. 136 and 137). If the brake shoe guide was not removed from the housing when the brake shoe was removed, do not alter its location. If the guide has been removed, however, screw it into the opening in the bottom of the housing with the lock nut in place on the guide.

(b) Install Brake Shoe in Housing (fig. 138). Slide the end of the shoe over the top of the brake drum, and allow it to fall down back of the drum until it contacts the guide. Reach through the housing opening, and pull shoe into place around the brake drum with the steering brake shoe adjusting rod at the top.

(c) Install the Brake Shaft and Bearing Plate (fig. 139). Insert splined end of the shaft through the brake housing opening and

TANK, MEDIUM, M4A3

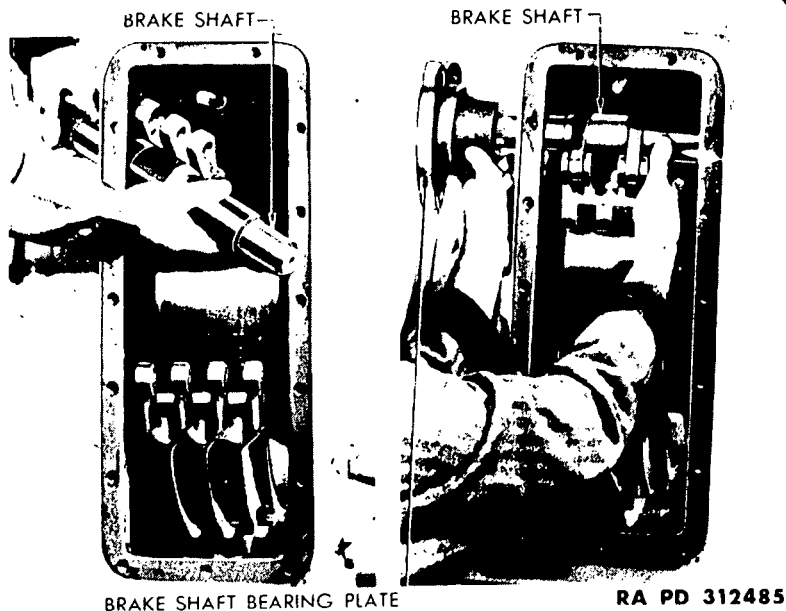

Figure 139—Installing Brake Shaft and Bearing Plate

out through the hole in the side of the housing. Rotate the shaft, and raise it until the inner end can be started into the inner bearing. Position the outer bearing plate on the splined end of the shaft, and slide the shaft out into the bearing plate. Tilt the inner end of the shaft upward, and move the bearing plate onto the shaft to clear the differential carrier plate nuts. Move the plate and shaft inward into the inner bearing. Install the bearing plate attaching cap screws. Aline the punch marks on the steering brake shaft and the steering brake shaft lever, and secure in place with the clamp cap screw.

(d) *Install Brake Lever Assembly* (fig. 140). Aline the holes in the brake shaft link and lever, and insert the hinge pin. Secure with a cotter pin. Lift the lower brake shoe and aline the holes in the lower end of the lever assembly with the holes in the brake shoe, insert the hinge pin, and secure with a cotter pin.

(e) *Assemble Adjusting Rod, Adjusting Washers, and Spring* (fig. 141). Insert the brake shaft swivel pin in the lever assembly, and aline the hole with the adjusting rod. Pull the rod through the brake shaft pin hole and install washers, spring, and adjusting nut.

(f) *Adjust Brake Shoe Guide* (fig. 136). Lift the brake shoe until shoes are in the approximate normal operating position. Apply br

POWER TRAIN ASSEMBLY

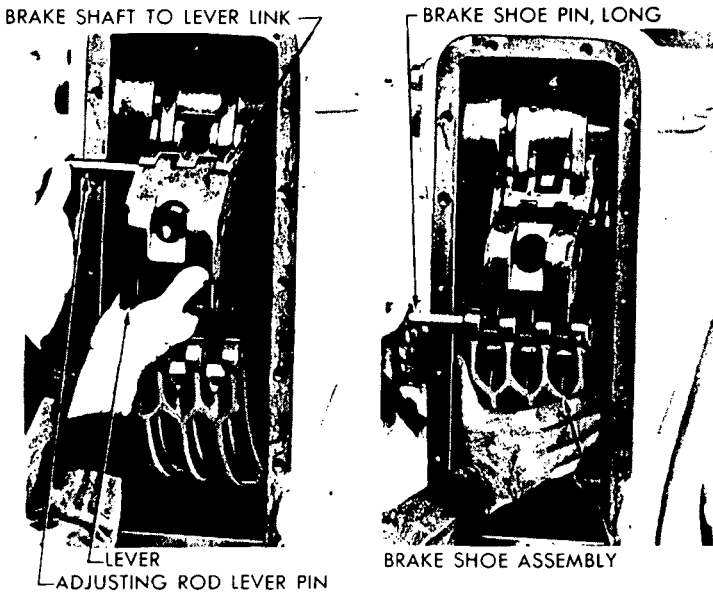

RA PD 312486

Figure 140—Installing Brake Lever Assembly

to tighten shoes against the drum, and move the lower shoe until the connecting pin is over the guide. Reach through the lower part of the opening under the brake shoe, and turn the guide up until it is in light but firm contact with the brake shoe, then turn down $\frac{1}{4}$ to $\frac{1}{3}$ turn to obtain correct clearance between the shoe and guide. This clearance should be 0.020 inch, which will maintain adequate minimum clearance between the drum and lining. Tighten lock nut and release the brake.

(g) *Install Steering Brake Reverse Anchor, Spring, Seal, and Retainers* (figs. 136 and 137). Install reverse anchor spring, reverse anchor to cover seal retainer, and seal. Install the reverse anchor with the hook over the short brake shoe pin, and hold in place by tightening reverse anchor thrust bolt fingertight.

(h) *Install Final Drive Housing Cover*. Using a new gasket, install cover by lifting up on adjusting rod nut, and apply the brake. This will allow the top of the shoe to rest on the cover pedestal. **CAUTION:** Make sure that reverse anchor spring, reverse anchor to cover seal retainer, and seal are in place before entering reverse anchor in the hole in the cover. Tighten the cover cap screws.

TANK, MEDIUM, M4A3

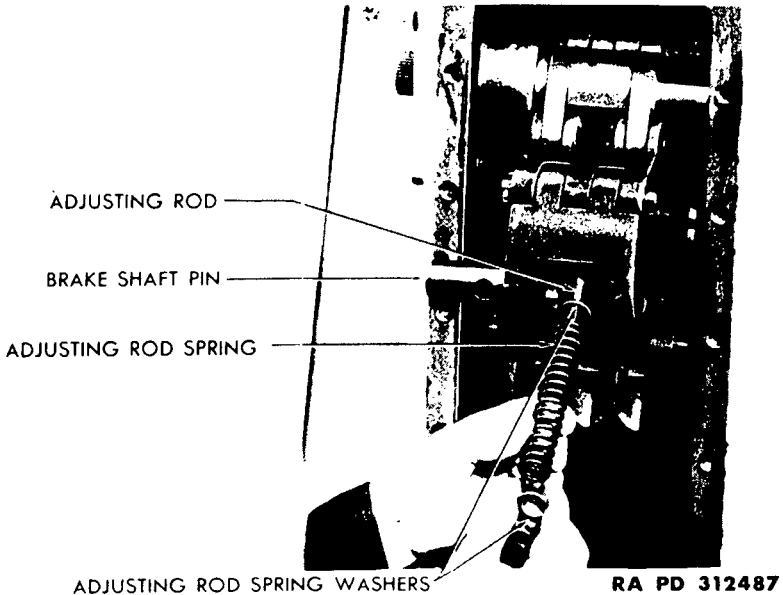

Figure 141—Installing Adjusting Rod Spring and Washers

(i) *Install Reverse Anchor Nut Seat, Adjusting Nut, and Jam Nut* (figs. 136 and 137). Install reverse anchor nut seat on reverse anchor with flat side toward the cover. Install adjusting and jam nuts.

(j) *Check Linkage Adjustment* (figs. 143 and 144).

(k) *Adjust Brakes* (par. 116 b).

(l) *Connect Steering Brake Linkage*. Position the right and left steering brake control rods with the clevis over the end of the steering brake cross shaft lever, insert the clevis pins, and secure with cotter pins.

(m) *Fill the Final Drive Housing with Lubricant*.

116. STEERING BRAKE ADJUSTMENT.

a. **Minor Adjustments.** Minor adjustments are made to compensate for normal lining wear when it is known that the external linkage is properly adjusted. Steering brakes should be adjusted for lining wear whenever steering levers must be pulled beyond the vertical position when making a normal turn (figs. 143 and 144). Check steering lever free travel daily

POWER TRAIN ASSEMBLY

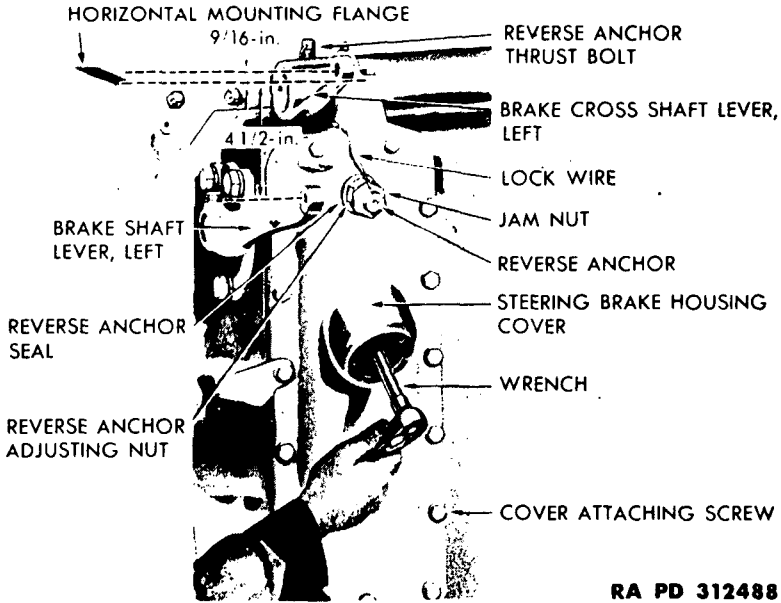

Figure 142—Adjusting Steering Brake

h. Adjustment (Both Types).

(1) Remove right and left control rod upper yoke pins (figs. 135 and 137).

(2) Remove adjusting hole cover plates or screw plugs from both brake drum housing covers (figs. 135 and 137).

(3) Turn adjusting rod nut clockwise, using a 1 1/8-inch deep socket wrench (fig. 142), one notch at a time, until steering lever free travel is reduced to between 4 and 5 1/2 inches before the brake lining is felt to contact the drum (figs. 143 and 144). Insert control rod yoke pins to check steering lever free travel. Steering levers must be parallel when both are pulled back with equal effort. Two types of adjusting rod nuts have been used on both single-anchor and double-anchor brakes.

(4) The first type is a long, hexagon nut with deep notch in one end which seats against the trunnion pin, keeping the nut from working loose. Always disconnect control rods when adjusting this type nut, as the depth of the notch will not allow the band to be taken up without damaging the nut and the trunnion pin.

(5) The second type nut is a long, hexagon nut, which is held from working loose by a spring clip engaging opposite sides of the nut. This type nut can be adjusted by 1/8-turn increments distinguish-

TANK, MEDIUM, M4A3

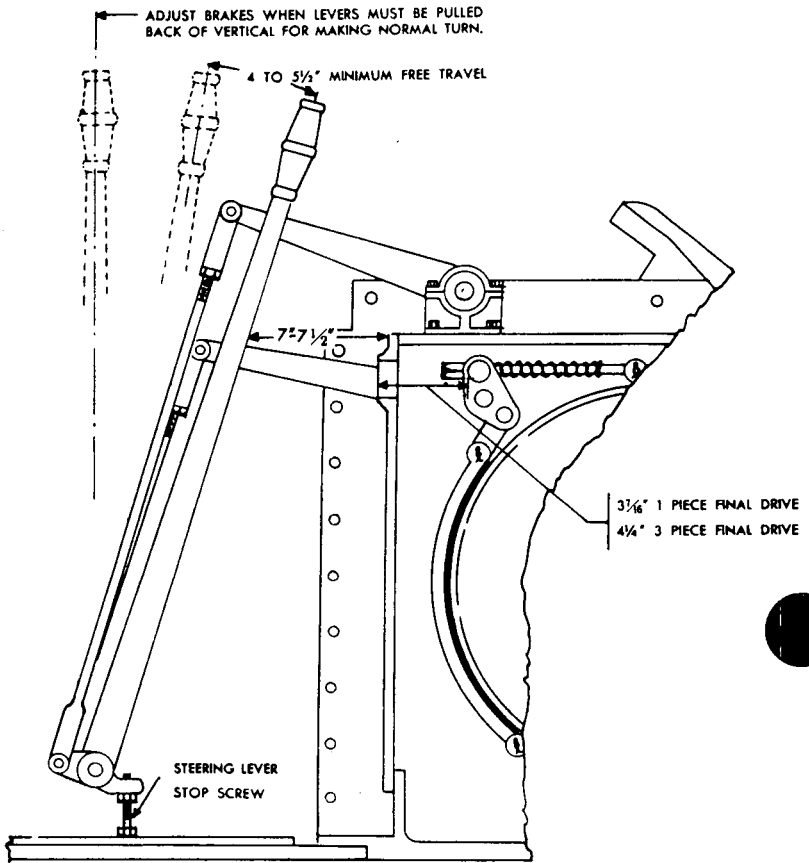

RA PD 336228

Figure 143—Single-anchor Brake Steering Lever and Brake Actuating Shaft Positions

able by “clicks,” whereas the first type nut can be adjusted only by $\frac{1}{2}$ -turn increments. **CAUTION:** *Free travel of steering levers must be at least 4 inches in order to provide minimum allowable clearance between brake lining and drum when steering levers are in full released position. Extreme care must be exercised not to get the brake band too tight, as insufficient clearance will result in excessive heating and damage to the lining by glazing.*

(6) Secure control rod yoke pins with cotter pins.

(7) Replace adjusting hole cover plates or screw plugs. Be sure that gasket is in good condition.

POWER TRAIN ASSEMBLY

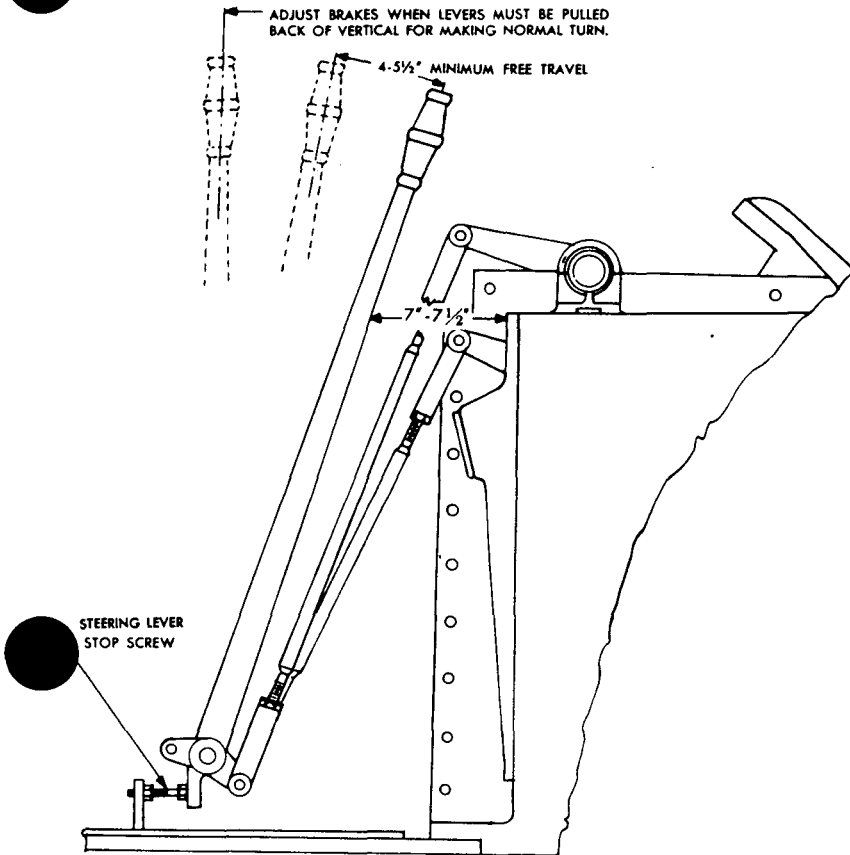

RA PD 336229

Figure 144—Double-anchor Brake Steering Lever Positions

c. Major Adjustments.

(1) **GENERAL.** Major adjustments are made to properly position the external linkage relative to the brake actuating shaft, to obtain maximum leverage from the external linkage after other adjustments are properly made. Major adjustments are made at time of final drive installation or at any time when doubt exists as to correctness of external linkage adjustment. Brake adjustment will be checked upon receipt of a vehicle, and a major adjustment or portion thereof made if required. Once external linkage is properly adjusted, it should not be disturbed.

(2) **SINGLE-ANCHOR BRAKE ADJUSTMENT.**

TANK, MEDIUM, M4A3

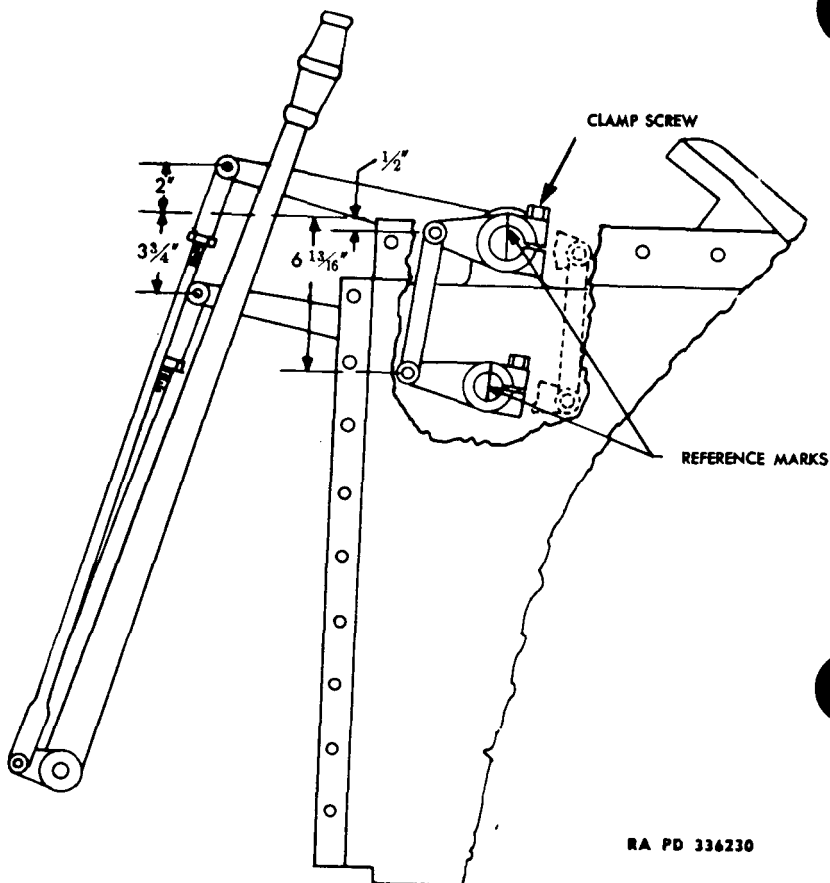

RA PD 336230

Figure 145—Single-anchor Brake, One-piece Final Drive Brake Lever Positions

(a) Check released position of steering levers. Levers are correctly positioned when horizontal distance from face of brake drum housing cover to front edge of lever is 7 to 7½ inches as shown in figures 143 and 144. In this position, tops of levers will be approximately 9 to 9½ inches ahead of vertical. If levers are not correctly positioned and parallel to each other, disconnect control rod upper yoke pins, and adjust stop screws at lower end of levers (figs. 143 and 144). Steering levers must be properly positioned, because if they are too far forward, the driver may be injured as a result of striking his face against the front of the hatch opening during cross-country operation.

POWER TRAIN ASSEMBLY

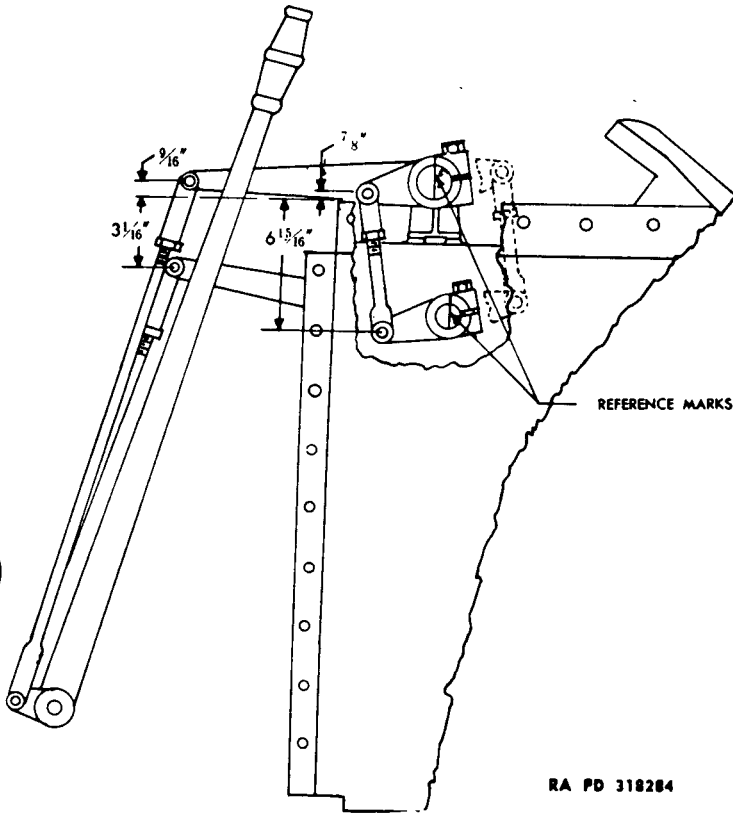
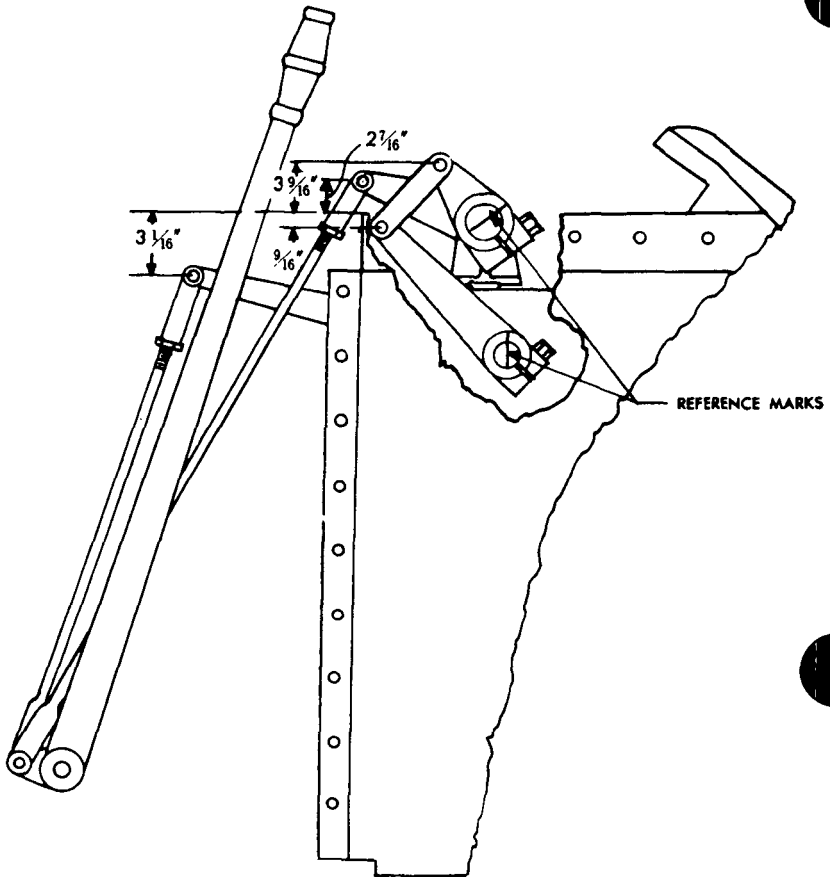

Figure 146—Single-anchor Brake, Three-piece Final Drive Brake Lever Positions

(b) Remove adjusting hole screw plugs as cover plates from both brake housing covers.

(c) Check position of cross shaft levers and brake actuating shaft levers with reference to top of final drive housing (figs. 145, 146, and 147). If levers are improperly positioned, adjust length of control rods as required to locate levers correctly. Back off adjusting rod nut to secure the desired position for the levers. For maximum leverage, levers should be positioned as closely as possible to dimensions given in figures 145, 146, and 147. However, accurate measurement

TANK, MEDIUM, M4A3



RA PD 318285

Figure 147—Single-anchor Brake, Three-piece Final Drive Brake Lever Positions

of these dimensions is rather difficult, and slight deviation is permissible since steering effort will not be noticeably affected.

(d) Check alinement of reference marks on both ends of cross shaft and on ends of right and left brake actuating shafts with marks on respective levers (figs. 145, 146, and 147). In case a lever is not properly installed, remove clamp screw, and slide the lever off the serrated shaft, then reinstall the lever on the shaft with reference marks in alinement, and replace clamp screw. In the absence of reference marks on ends of cross shafts and brake actuating shafts on single-anchor brakes, proceed as follows:

POWER TRAIN ASSEMBLY

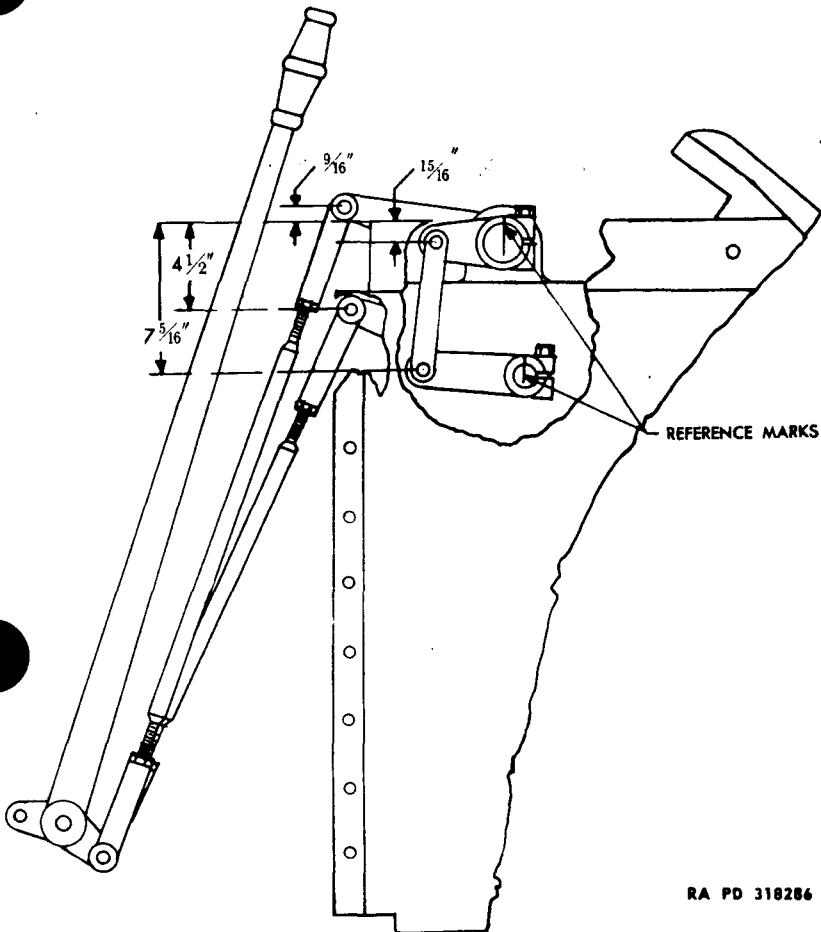

RA PD 318286

Figure 148—Double-anchor Brake, One-piece Final Drive Brake Lever Positions

(e) With cross shaft and brake actuating shaft levers attached to control rods, check location of brake actuating shaft trunnion pin by measuring the distance from the outer face of the adjusting hole flange on the brake drum housing cover to the nearest surface of the trunnion pin against which the adjusting rod nut seats. This dimension should be approximately $3\frac{1}{16}$ inches on the one-piece final drive housing and $4\frac{1}{4}$ inches on the three-piece final drive housing.

(f) If brake actuating shaft is improperly located, remove clamp screw, and slide lever off serrated shaft. Reinstall lever in proper

TANK, MEDIUM, M4A3

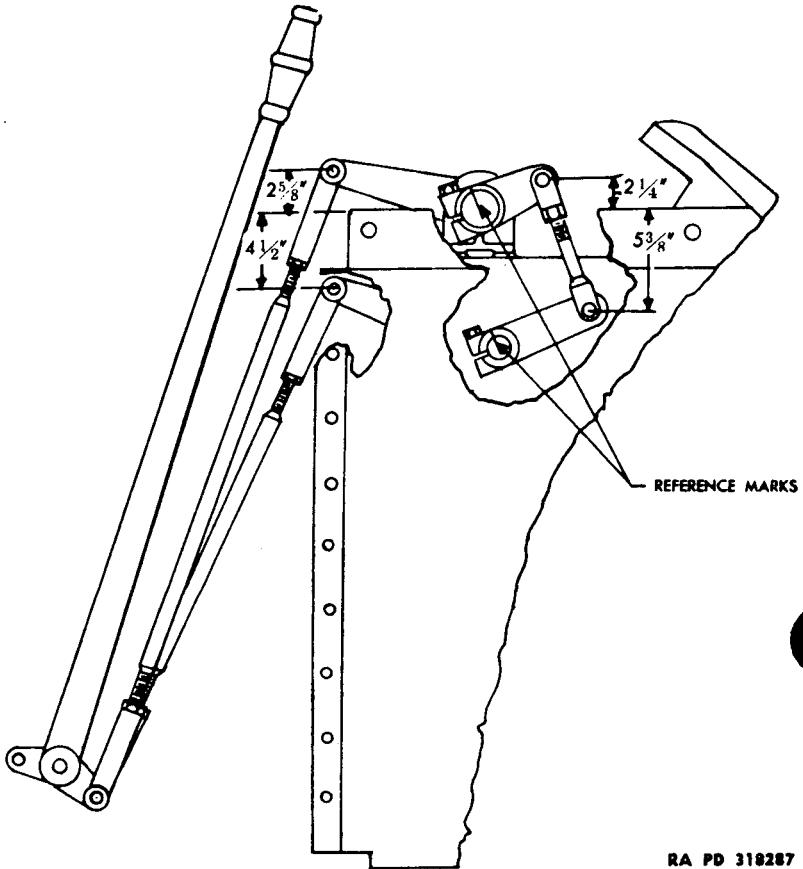

RA PD 318287

Figure 149—Double-anchor Brake, Three-piece Final Drive Brake Lever Positions

relationship to the actuating shaft, and replace clamp screw. Mark ends of levers and shafts with cold chisel for future reference.

(g) There are three different right-hand linkage arrangements used with a single-anchor brake as illustrated in figures 145, 146, and 147. In some cases, levers may be found installed backward as indicated by dotted lines in figures 145 and 146. If there is any doubt of the correct position of these levers, remove and reinstall correctly.

(h) Follow through minor adjustment procedure (par. 116 b).

(3) DOUBLE-ANCHOR BRAKE ADJUSTMENT.

POWER TRAIN ASSEMBLY

(a) Follow through steps (1) through (7) of single-anchor brake adjustment procedure in subparagraph b above, referring to figures 148 and 149 instead of figures 145, 146, and 147

(b) Check reverse anchor adjustment by prying reverse anchor nut away from brake drum housing cover. Reverse anchor end play should be approximately $\frac{1}{16}$ inch. If end play is correct, follow through subparagraphs (c), (d), and (e) below.

(c) Loosen reverse anchor lock nut, and reverse anchor thrust bolt lock nut.

(d) To adjust reverse anchor, tighten reverse anchor adjusting nut tight, and back off $1\frac{1}{2}$ turns. Tighten lock nut. Pry reverse anchor lock nut away from brake drum housing cover. End play of reverse anchor should be approximately $\frac{1}{16}$ inch to $\frac{1}{8}$ inch.

(e) To adjust reverse anchor thrust bolt, tighten bolt until it bottoms on the reverse anchor, then back off one turn and tighten lock nut.

(4) RECENTERING BRAKE BAND (SINGLE- AND DOUBLE-ANCHOR BRAKES)

(a) The brake adjustment procedure as outlined in paragraph 116 c shortens the band to take up lining wear, but does not recentre the band to restore approximately equal clearance all the way around drum. Band support clearance will be checked and adjusted at each oil change interval, that is, every 3,000 miles or sooner if oil is changed before that time.

d. Adjustment of Band Support Screw (Both Types).

(1) Drain oil from final drive housing. Remove brake drum housing cover plates. On double-anchor brake, it is necessary to remove reverse anchor lock nut, reverse anchor adjusting nut, and adjusting nut seat before removing cover plates.

(2) Apply brake to hold band snugly against drum.

(3) Loosen brake shoe support screw lock nut, and turn support screw until it is in light but firm contact with the band. Turn support screw down until clearance between band and support is 0.010 inch. Tighten lock nut and release brake.

(4) Replace brake drum housing cover. On double-anchor brake, lift up adjusting nut to insure that band will rest on cover pedestal (fig. 137). Check to be sure that reverse anchor spring, reverse anchor seal retainer, and seal are in place before entering reverse anchor in the hole in the cover. Replace reverse anchor adjusting nut seat, adjusting nut, and lock nut after brake housing cover is installed.

(5) Refill final drive to prescribed level with proper grade of oil.

TANK, MEDIUM, M4A3

(6) Follow through major and minor brake adjustment procedures.

117. STEERING BRAKE CONTROL LEVERS.

a. Removal.

(1) **REMOVE DRIVER'S SEAT AND PARKING BRAKE QUADRANT.** Remove the bolts and nuts which secure the driver's seat to its base, and lift out the seat.

(2) **REMOVE THE FLOOR PLATE.** Remove the fillister-head cap screws and lift floor plate from its supports.

(3) **REMOVE STEERING BRAKE CONTROL LEVERS (fig. 137).** Remove the three clips and two nuts which hold the horn wire conduit and horn button to the right-hand steering lever if located on the steering brake. Remove the horn wire and button from steering lever. Remove the clevis pins connecting the steering brake control rods to the steering brake control levers. Remove the cotter pin at the left end of steering brake control lever shaft. Drive the shaft out toward the transmission, being sure that the spacers between the levers and at either end of the shaft are not lost.

(4) **CHECK ADJUSTMENT OF STEERING BRAKE CONTROL LEVER STOP SCREWS (fig. 137).** Loosen lock nut, and adjust the stop screw to 1 $\frac{3}{4}$ inches from the face of the bracket to the face of the screw head.

b. Installation.

(1) **INSTALL STEERING BRAKE CONTROL LEVERS (fig. 137).** Place one spacer on the lever shaft and align the right lever with hole in bracket, and insert the shaft through the bracket and lever just far enough to allow the spacer and the other lever to be installed on the shaft. Position the left lever, align the hole with the shaft, and drive the shaft through the lever and bracket. Install the outer spacer on the shaft, and cotter pin in end of the shaft. Install the clevis pins connecting the steering brake control rods to the steering brake control levers. Place horn wire conduit and horn button in position on the right-hand steering lever, and secure to the lever with three clips and two nuts.

(2) **INSTALL FLOOR PLATE AND DRIVER'S SEAT.** Position the floor plate on the supports, install the fillister-head screws, and tighten securely. Place the driver's seat on its base, and attach with bolts and nuts.

118. DRIVE SPROCKET AND HUB.

a. Description. Each drive sprocket assembly is made up of two sprockets bolted to a hub. The hub is bolted to the flange end of

POWER TRAIN ASSEMBLY

final drive shaft flange. The sprockets and or hubs are interchangeable, and may be transposed from right to left final drive shafts when the teeth have been appreciably worn.

b. Removal.

- (1) **DISCONNECT TRACK.** See paragraphs 125 b or 133 a.
- (2) **REMOVE SPROCKET AND HUB ASSEMBLY.** Remove the nuts which attach the hub to the final drive shaft, and remove the dowel washers. Drive off the sprocket and hub assembly. Remove the cap screws which attach the sprockets to the hub, and lift off the sprockets.

c. Installation.

- (1) **INSTALL SPROCKET AND HUB ASSEMBLY.** Position sprocket on hub, aline holes, install the cap screws and tighten. Lift sprocket and hub assembly into position on final drive shaft studs. Install the dowel washers and nuts, rotating the tightening of the nuts evenly around the hub.
- (2) **CONNECT TRACK.** See paragraphs 125 c or 133 b.
- (3) **ADJUST TRACK TENSION.** See paragraphs 125 d or 133 d
- (2).

119. FINAL DRIVE ASSEMBLIES.

a. Removal (fig. 133).

- (1) **DRAIN OIL.** Remove the two plugs from the bottom of the final drive housing, and drain the oil.
- (2) **DISCONNECT TRACK.** See paragraphs 125 b or 133 a.
- (3) **REMOVE DRIVE SPROCKET AND HUB.** See paragraph 118 b.
- (4) **REMOVE FRONT FENDERS.** See paragraph 138 c.
- (5) **REMOVE FINAL REDUCTION ASSEMBLY.** Support the final reduction assembly with hoist or other means, and remove the cap screws which attach the cover to the final drive housing. Use a small pinch bar to pry the unit away from the housing, and continue to manipulate the unit until it is free of the compensating shaft splines.

b. Installation.

- (1) **INSTALL FINAL REDUCTION ASSEMBLY.** Remove all traces of torn gaskets from the mounting faces of the final drive cover and housing, and cover the surfaces with sealing compound. Position new gasket on housing, and aline all the holes. Lift final reduction assembly into place with a hoist, or by other means, and assemble to the final drive housing, rotating the final drive shaft slowly to right and left until the compensating pinion meshes on the compensating shaft splines. Slide the assembly into place over the locating dowels.
- (2) **INSTALL ATTACHING CAP SCREWS.** Install all of the cap screws and lock washers except the three for the front fender directly

TANK, MEDIUM, M4A3

over the center of the final drive cover. Tighten evenly around unit. Fill the final drive assembly with lubricant.

- (3) **INSTALL FRONT FENDER.** See paragraph 138 c.
- (4) **INSTALL DRIVE SPROCKET AND HUB ASSEMBLY.** See paragraph 118 c.
- (5) **CONNECT TRACK.** See paragraphs 125 c or 133 b.
- (6) **ADJUST TRACK TENSION.** See paragraphs 125 d or 133 d (2).

120. PARKING BRAKE MECHANISM.

a. Description. The later-type parking brake consists of two quadrants, one attached to each steering lever. A kick pedal provided with springs and pawls is mounted ahead of the quadrants. When the kick pedal is in the lowered position, contact is made with the quadrants on the steering brake control levers, holding them in any set position. The earlier type is a transmission-type parking brake, and is located at the rear of the transmission.

b. Parking Brake Replacement (Transmission Type).

(1) **REMOVAL.** Remove eight cap screws from universal joint front cover and remove the cover. Remove the cotter pin and washer from the parking brake lever shaft and remove the shaft and lever. Remove the seven bolts which hold the parking brake housing to the transmission. Pull the housing off the brake shoe spline and move the housing. Remove the brake shoe cone.

(2) **INSTALLATION.** Install the brake shoe cone, and place the housing over the brake shoe spline and install the seven bolts. Select a position on brake shoe spline so that brake shaft spacer will mesh into recess in spline. Install the parking brake lever shaft and install the washer and cotter pin. Install the front universal joint cover.

121. TRANSMISSION OIL COOLER REPLACEMENT.

a. Removal. Disconnect the inlet and outlet line from the top and bottom of the cooler. Unscrew the cooler guard to hull attaching cap screws, and lift the guard up and into the turret basket. Remove the cooler to bracket attaching bolts at each corner and lift out the cooler.

b. Installation. Position the oil cooler in the brackets, and install mounting bolts and nuts. Place the cooler guard in position over the cooler, and install cap screws. Screw the oil tube connectors into the top and bottom connections of the cooler. Fill the transmission and final drive assembly with lubricant (par. 29 d (9)). operate the engine with clutch engaged, and inspect cooler and connections for leaks.

POWER TRAIN ASSEMBLY**POWER TRAIN ASSEMBLY REMOVAL.**

a. **General Information.** The using arm is authorized to remove and install a transmission and final drive assembly. However, the replacement of this assembly with another assembly must not be done by the using arm unless authorization is received from ordnance personnel. Removal of the power train assembly from the tank is a major operation that will require several hours. Because of its size and weight (8,800 lb), a fixture (41-F-2997-220) and wrecker are necessary to remove the assembly.

b. **Disconnect Tracks on Both Sides.** See paragraphs 125 b or 133 a.

c. **Drain Oil From Transmission and Final Drive Assembly.** Remove the three drain plugs, one under each final drive housing, and one in the transmission housing. The plugs are magnetized. Clean thoroughly and install.

d. **Remove Front Fenders and Sand Shields (Both Sides).** Turn the bayonet-type attaching pins one-quarter turn until each pin aligns with the slot in the hull, and lift off the shields. Remove the front fender attaching bolts and cap screws, and remove the fenders.

Remove Final Drive Sprocket and Hub Assemblies. See paragraph 118 b.

f. **Disconnect Front Universal Joint and Generator Drive Pulley.** Turn off the radio and battery master switch. If the generator is located to the rear of the transmission, loosen the lock nut on the adjusting bolt, and turn the bolt counterclockwise to relieve the tension on the drive belts. Remove the cap screws from the generator drive belt cover, and remove the cover. Remove the generator drive pulley bolt nuts. Remove the drive belts, and slide the pulley toward the rear. Remove the universal joint to transmission input shaft flange bolts. Remove the thumb screw from the generator junction box cover, and remove the cover. Disconnect the two generator wires in the junction box. Disconnect the knurled nut on the conduit leading from the junction box. Remove conduit and wires from the junction box.

g. **Disconnect Speedometer and Tachometer Cables.** Unscrew the knurled nut which secures the speedometer cable housing (G104-17-89553) to the adapter at the upper right rear of transmission, and separate cable and housing from the adapter. If the tachometer cable (G104-17-89553) is connected to the transmission, disconnect the tachometer cable located on the top left rear of the transmission in the same manner.

TANK, MEDIUM, M4A3

h. Disconnect Transmission to Cooler Oil Tubes. Unscrew the flexible oil hose connectors at the transmission, and separate the oil hoses (A-345752-F) and A-3457526) from the connection. Unscrew the connections to oil lines, from left side of transmission.

i. Remove Hatch Hood and Periscope Stowage Rack. Remove the bolts at the front and rear of the stowage rack, and remove the rack from the transmission.

j. Remove Horn Button Conduit from Power Train. Remove the horn wire conduit or the siren button from the power train assembly.

k. Disconnect Steering Brake Linkage, Hand Throttle, and Primer Pump. Remove the two clevis pins at the top of the steering brake control rods. Loosen the lock nut on hand throttle bracket, and lay hand throttle and cable to one side. Remove primer line clip on power train and disconnect the primer lines near the bottom of the left side of the transmission. Remove the four cap screws which hold the primer pump bracket to the power train, and remove the primer pump and bracket assembly. Remove the hand throttle and primer pump bracket.

l. Disconnect Machine Gun Mount Spring Bracket and Portable Fire Extinguisher Bracket. Remove the two attaching screws from the spring anchor bracket. Remove the countersunk head screws attaching the portable fire extinguisher bracket to the floor, and remove the bracket.

m. Remove Steering Brake Cross Shaft Assembly. Disconnect the right end of the steering brake cross shaft lever from the steering brake control rod. Remove the screws which secure the cross shaft brackets, and lift the cross shaft assembly off the final drive housing.

n. Remove Front Wire Conduit Clamps. Remove the screws which secure the front conduit clamps to the hull, to allow access to nuts which hold the final drive assembly to the hull.

o. Remove Power Train Assembly (fig. 150). Hold the nuts inside the hull, and remove the two lower bolts (one on each side) from the side of the hull on the outside. Insert the two small aligning pins of special fixture (41-F-2997-220) in the holes. Attach a chain to the two towing clevises in the front of the vehicle. Back a wrecker up to the front of the vehicle, hitch the winch cable to the chain, and take up the slack. Remove all the bolts which secure the power train to the hull. Slack off the winch cable until the top of the power train is tilted away from the hull far enough for the fixture (41-F-2997-220) to be installed. Bolt the fixture to the upper top edge of the power train (fig. 150). Hitch the wrecker

POWER TRAIN ASSEMBLY

LIFTING EYE

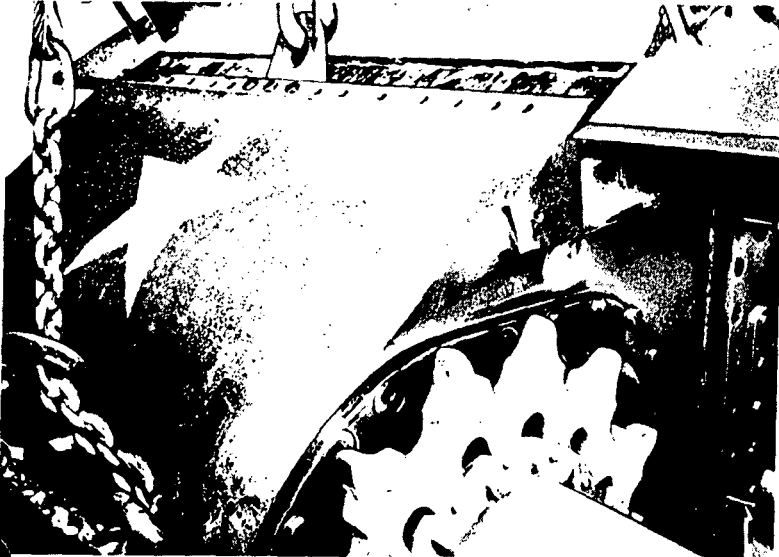

ALINING PIN

ALINING PIN

ALINING PIN

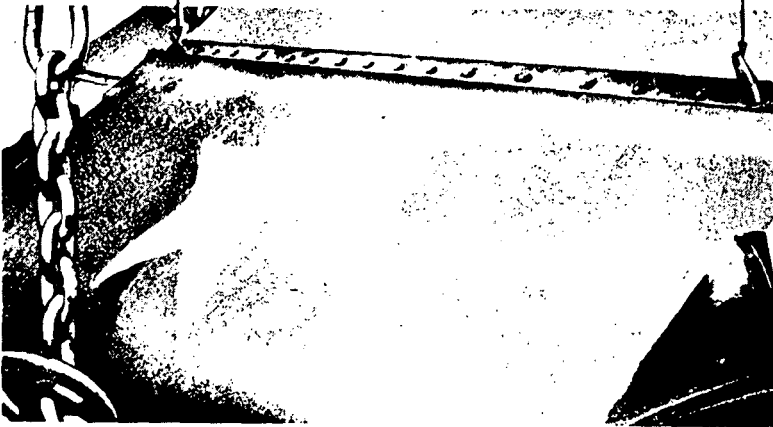

Figure 150—Removing Power Train Assembly Using Special Fixture (41-F-2997-220)

TANK, MEDIUM, M4A3

boom cable to the fixture, drive out the alining pins, and carefully guiding the assembly from inside the tank, remove it carefully. Slack off on the winch cable as the assembly is pulled from the tank, to allow clearance at the gearshift fulcrum and the oil tubes.

123. POWER TRAIN ASSEMBLY INSTALLATION.

a. **Install Power Train Assembly** (fig. 150). Place the two long spacer shims in position in each side of the hull with sealing compound, and insert two bolts through the hull so the threaded ends of the bolts enter the shims far enough to prevent them from falling out of place. Apply sealing compound to other contacting surfaces. Attach the lifting fixture (41-F-2997-220), chain, and wrecker to power train. Move the wrecker, with the assembly suspended, to the hull opening, and aline the assembly with the hull. Back the wrecker slowly toward the hull, lowering the boom cable until the power train is tipped forward slightly at the top, and carefully guide the lower side into the hull opening. Insert the two small alining pins in the lower holes (one on each side), making sure the pins pass through the hull and the power train holes. Suspend the weight of the power train from the winch cable which is hitched to the towing clevises. Slack off the boom winch cable, and remove the lifting eye. Tilt the power train back until the top edge is into the hull. Insert the two large alining pins of special lifting fixture (41-F-2997-220) through holes along the top edge of the hull in order to aline the holes.

b. **Install Attaching Bolts.** *NOTE: It may be necessary to ream some of the holes slightly to install the bolts.* Install bolts across the top left end with heads outside. Install bolt at the lower left end with the head outside. Install the next upper four bolts, with heads inside the hull and the nuts outside. Then install the remaining bolts at the left end from the outside. Install the remaining bolts from the outside of the hull. Hold bolts or nuts on the inside, and tighten the outside.

c. **Install Front Wire Conduit.** Position the front wire conduit along the front hull slope just above the final drive housing attaching bolts and nuts, and attach the clamps to the hull.

d. **Install Brake Cross Shaft Assembly.** Position the cross shaft assembly on the top of the final drive housing, insert the cap screws with lock washers through the brackets, and tighten securely. Connect the steering brake control rod to the right side of the steering brake cross shaft, and secure with a cotter pin. Position machine gun mount spring on the seat, and attach the lower bracket to the bearing cap.

POWER TRAIN ASSEMBLY

Install Horn Button Conduit. Attach the horn switch or the siren button conduit to the power train assembly.

f. Install Stowage Rack. Set the rack in position, and secure it to the transmission at the front and rear with bolts.

g. Connect Steering Brake Control Lever Linkage. Position the right and left steering brake control rods with the clevis over the end of the steering brake cross shaft lever, insert the clevis pins, and install the cotter pins.

h. Connect Transmission Oil Cooler Tubes. Screw the two oil line connections into the openings at the left side of the transmission. Aline and tighten securely. Attach oil tubes to connections, and tighten securely.

i. Install Hand Throttle and Primer Pump Assembly Bracket. Place the bracket and primer pump assembly in position on the left side of the power train, insert the cap screws and lock washers, and tighten securely. Connect the primer lines near the bottom of the left side of the transmission. Secure primer lines to power train with a clip. Place hand throttle in position in bracket, and tighten lock nut.

Connect Speedometer Cable, Tachometer Cable and Portable Fire Extinguisher Bracket. Place end of speedometer cable in opening in the adapter at the right rear side of transmission, and screw the knurled nut onto adapter securely. Connect the tachometer cable in the same manner if not connected to the engine. Position the portable fire extinguisher bracket with the clamp away from the transmission, and attach the bracket to the floor.

k. Connect Front Universal Joint.

l. Adjust Generator Drive Belts. If the generator mounting is located to the rear of the transmission, lower it until the belts can be depressed one-half inch, and tighten the adjusting arm bolt.

m. Fill Transmission and Final Drive Assembly With Lubricant.

n. Install Front Fenders. Remove the three fender attaching cap screws at the top of the final drive cover. Position fender on hull and final drive housing, install the cap screws and bolts, and tighten securely.

o. Install Final Drive Sprocket and Hub Assemblies. See paragraph 118 c (1).

p. Connect Tracks. See paragraphs 125 c or 133 b.

Adjust Track Tension. See paragraphs 125 d or 133 d (2).

TANK, MEDIUM, M4A3

Section XXIII

HORIZONTAL VOLUTE SPRING, SUSPENSION
AND TRACKS

124. DESCRIPTION.

a. **Tracks** (fig. 151). Two individually driven tracks propel the vehicle forward and backward. The drive sprockets at the front end of the vehicle pull the tracks from the rear and lay them down in front of the advancing suspension wheels. An adjustable idler with dual wheels for each track is mounted at the rear of the hull for adjusting the tension of the tracks. The track is 23 inches wide with a center guide that minimizes the possibility of throwing the track. The upper portion of each track is supported on two dual rollers and three single rollers, all of which are rubber-tired and fitted with adjustable tapered roller bearings.

b. **Suspension Assemblies** (fig. 159). The vehicle is supported on six suspension assemblies bolted to the hull. Each suspension has four rubber-tired wheels, one pair mounted on each suspension arm. The wheels are of the demountable type that can be removed from the hubs and installed without disturbing the adjustable tapered roller bearings or any part of the suspension tracks. The tires are mounted directly to the wheels. The suspension wheel support arms are connected to the suspension by rubber-bushed pins. Two horizontal volute springs in each suspension are held in position by spring seats that rests on spring seat pins. The spring seats are free to swivel on the seat pins, allowing the volute spring to compress in true alinement without distortion.

c. **Shock Absorbers** (fig. 159). A telescopic type, hydraulic shock absorber is connected between the support arms on each of the suspensions. The shock absorbers reduce the pitching action of the vehicle by stabilizing the vertical movement of the suspension wheels when passing over rough terrain.

d. **Data.**

Width of track	23 in.
Weight of track (with 79 shoes)	3,500 lb
Ground contact area of track (approx)	7,000 sq in.
Ground pressure (pounds per sq in.)	10.2
Length of springs (new)	14 in.
Diameter of suspension wheel	20½ in.
Diameter of idler wheels	22 in.
Diameter of dual track roller	13½ in.
Diameter of single track roller	10 in.
Number of lubricant fittings	36

HORIZONTAL VOLUTE SPRING, SUSPENSION AND TRACKS

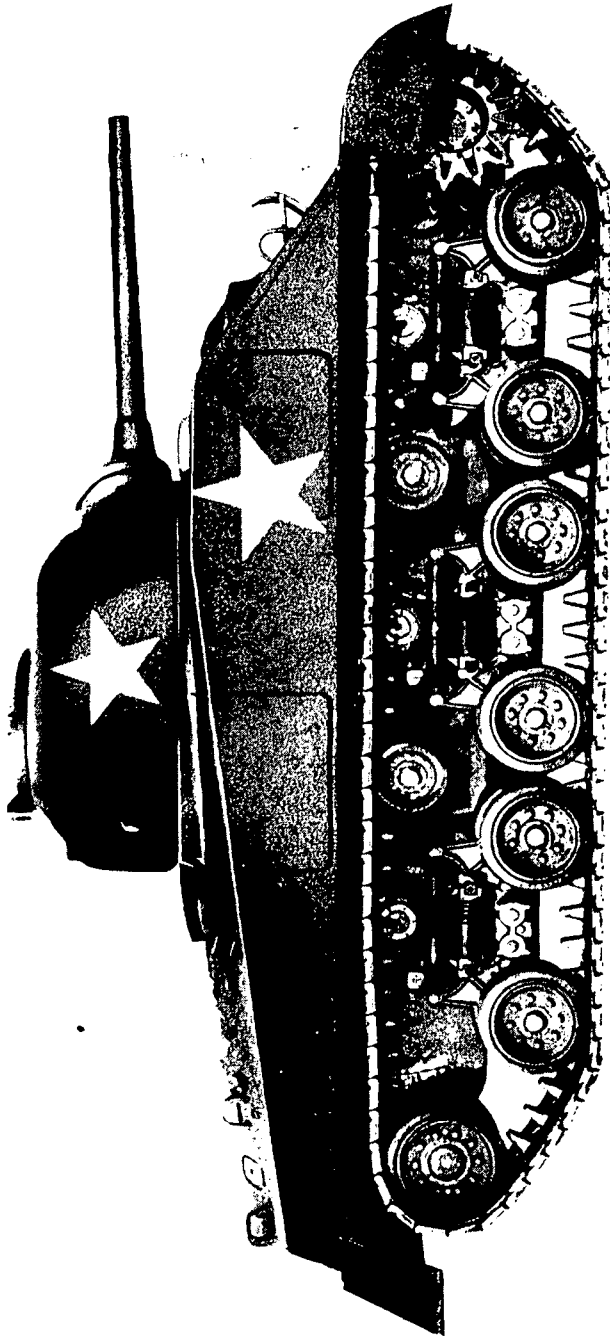

RA PD 313333

Figure 151—Horizontal Volute Suspension Installed on Medium Tank M4A3

TANK, MEDIUM, M4A3

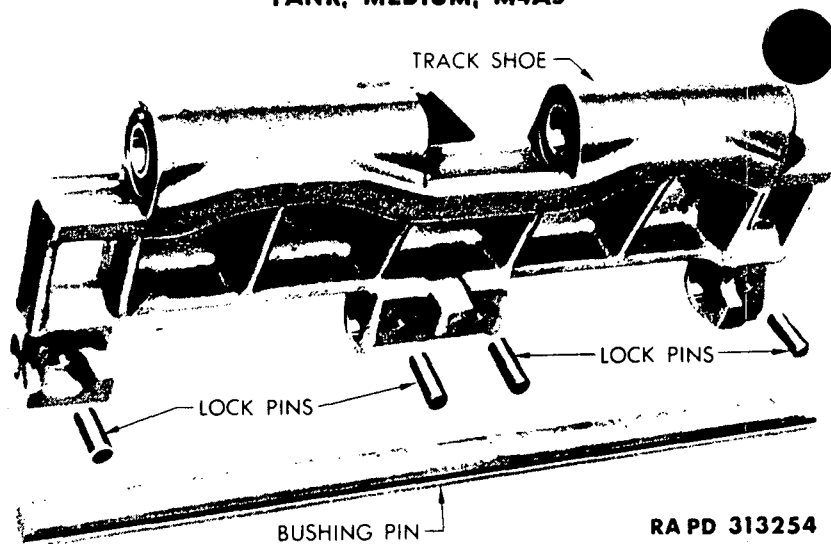

RA PD 313254

Figure 152—Track Shoe Disassembled**125. TRACKS.**

a. **Description** (fig. 151). Only one pin is used in each Rubber bushings are bonded to a steel track shoe bushing tube and bushings are pressed into the track shoe. The tubes have two keys that engage the two keyways milled in the track shoe bushing pin. The pin is held in position in the shoe by four pins with flat tapered sides that engage depressions machined in the shoe pin.

b. **Removal** (fig. 153). Place the vehicle on level terrain so that it can be moved as required. Release the track tension at the idler adjustment (subpar. d (2) below). Disconnect the track between the front suspension wheel and the sprocket. (If the track has been thrown, disconnect the track underneath either the idler or the sprocket, depending on which end of the track has the least twist.) Install the track connecting fixtures. Drive out the lock pins that retain the track shoe bushing pin from the guide side of track shoe. Drive out the shoe bushing pin. Lay the top half of the track on the ground to the front or rear of the vehicle, depending on which end of the track has been disconnected.

c. Installation.

(1) **INSTALL TRACK.** If a new track is to be installed, lay it in front of and in alignment with the old track. If a thrown track is to be installed, dig a trench deep enough for the end of the track so that the suspension wheel can roll directly onto the track. Tow the vehicle onto the track until about 16 inches of the end protrudes

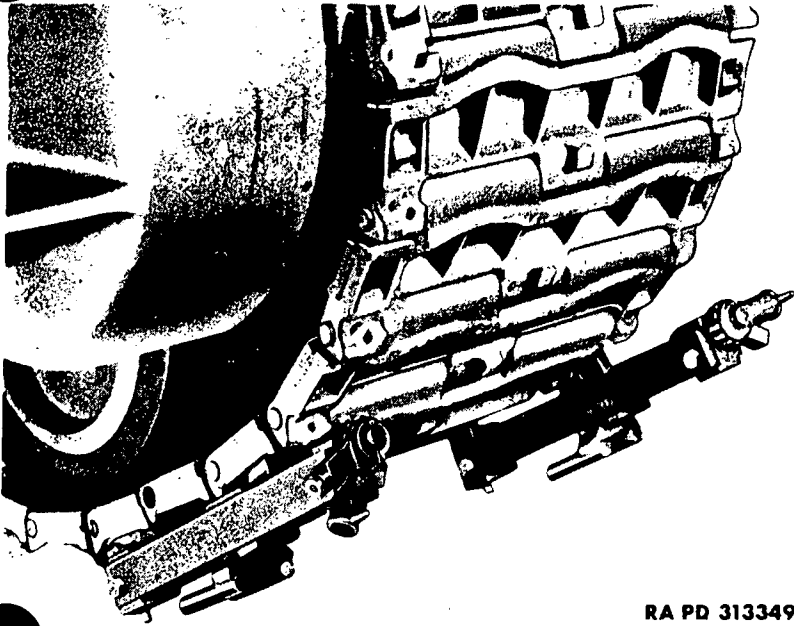
HORIZONTAL VOLUTE SPRING, SUSPENSION AND TRACKS

RA PD 313349

Figure 153—Track Connecting Fixtures (41-F-2997-86) Installed

yond the front suspension wheel. Block the suspension wheels in the track to prevent the vehicle from moving. Place the rear idler wheel in the extreme forward position and lock the spindle in the bracket to prevent breakage of the idler bracket. Roll the end of the track over the idler wheel and pull the track forward over the support rollers and sprocket with a cable attached to a towing unit.

(2) **CONNECT TRACK SHOES** (fig. 153). Attach the track connecting fixtures to the ends of the track and draw the ends together. Install the track shoe bushing pin. Install the bushing pin retaining lock pins. Drive the pins into the shoe, from the grouser side, until they seal solidly and stake the shoe around the head of the pins. Remove the track connecting fixtures.

(3) **ADJUST TRACK TENSION.** See subparagraph d below.

d. Adjustment of Track Tension.

(1) **POSITION TRACK FOR ADJUSTMENT** (fig. 154). Place a wood block $\frac{3}{4}$ inch thick and 2 inches wide between the track and each dual support roller.

(2) **RELEASE TRACK TENSION** (fig. 154). Loosen the two out-

TANK, MEDIUM, M4A3

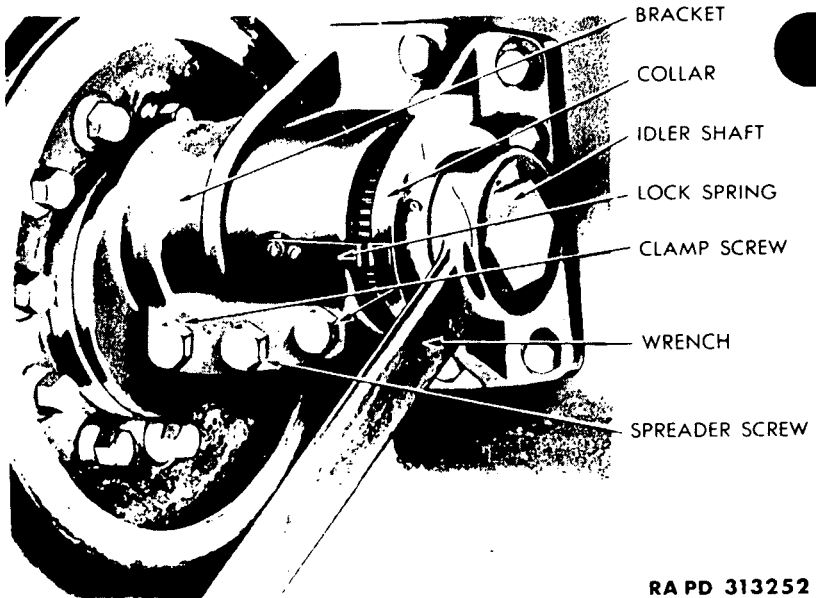
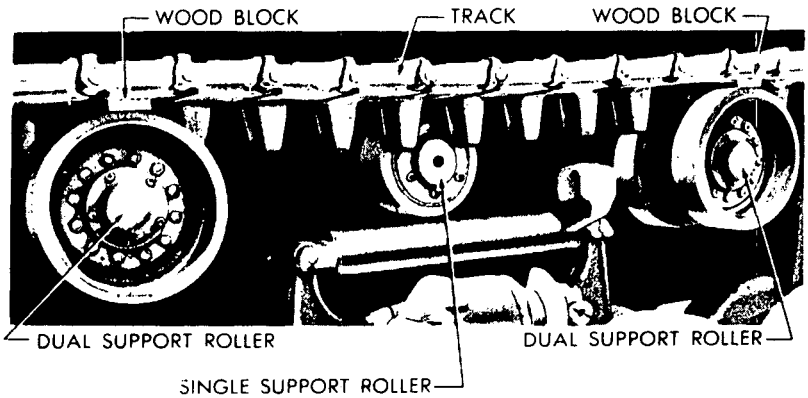

RA PD 313252

Figure 154—Adjusting Track Tension With Wrench (41-W-640-4)

HORIZONTAL VOLUTE SPRING, SUSPENSION AND TRACKS

the clamp screws in the idler wheel bracket. Turn the spreader screw counterclockwise to spread the bracket until the spindle is free. **CAUTION: Excessive spreading will crack the bracket.** Place the adjusting wrench on the hexagon at the end of the idler shaft and turn the shaft to release the bind on the adjusting collar. Raise the spring at the end of the bracket and slide the collar off the serrations on the idler shaft.

(3) **ADJUST TENSION** (fig. 154). Use a piece of pipe on the handle on the adjusting wrench for leverage and raise the handle of the wrench to tighten the track. Slide the adjusting collar on and off the serrations on the shaft when changing the wrench position. Tighten the track until the track just clears the single support roller.

(4) **LOCK IDLER ADJUSTMENT** (fig. 154). Slide the adjusting collar onto the serrations of the shaft and lock it in place with the spring. Back out the center spreader screw by turning it clockwise until it does not project through the split in the bracket. Tighten both outside clamp screws securely, then tighten the center spreader screw until it binds sufficiently to hold itself from working loose. Remove the idler adjusting wrench.

126. IDLER WHEELS AND BRACKET.

a. **General.** The outer idler wheel can be removed without disconnecting the track by releasing the track tension. The inner wheel can be removed without disturbing the hub or bearings by removing the idler shaft from the bracket.

b. Removal and Disassembly (fig. 155).

(1) **DISCONNECT TRACK.** See paragraph 125 b.

(2) **REMOVE IDLER WHEEL AND HUB ASSEMBLY.** Take out the attaching cap screws and remove the hub cap and gasket. Pry the tongue of the nut lock out of the outer bearing nut. Unscrew the outer bearing nut and remove the nut lock. Unscrew the inner bearing nut and remove the thrust washer. Pull the wheels and hub off the idler shaft.

(3) **REMOVE BEARING CONES AND SEAL.** Remove the outer bearing cone. Pry the seal out of the hub. Remove the inner bearing cone.

(4) **REMOVE IDLER SHAFT AND BRACKET.** Remove the cotter pin in the hexagon end of the shaft. Slide the collar off the shaft. Pull the idler shaft out of the bracket. Take out the cap screws that attach the bracket to the hull and remove the bracket.

c. **Cleaning of Parts.** Clean all parts thoroughly. Use water under pressure to loosen and remove as much foreign matter as possible. Use a stiff brush and dry-cleaning solvent to remove the

TANK, MEDIUM, M4A3

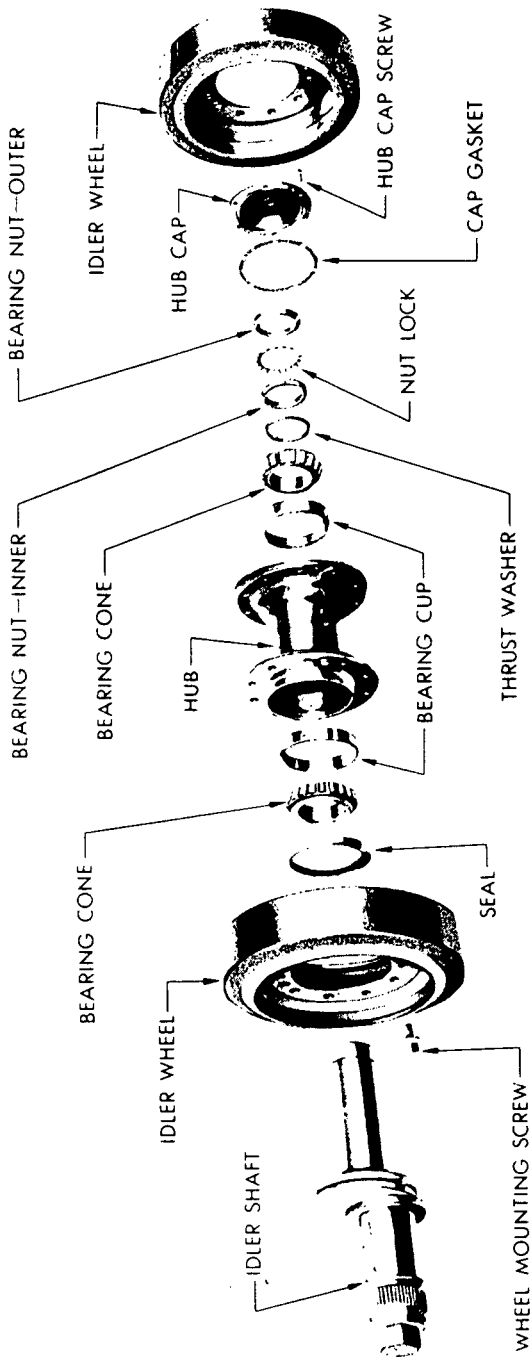

RA PD 313335

Figure 155—Tractor Idler Disassembled

HORIZONTAL VOLUTE SPRING, SUSPENSION AND TRACKS

removing grease and dirt. Rotate the bearings while immersed in dry-cleaning solvent until all traces of lubricant have been removed. **CAUTION:** *Do not spin bearings with compressed air.* Oil the bearings immediately to prevent corrosion of the highly polished surfaces and wrap them in oiled paper if they are not to be used at once.

d. Inspection of Bearings and Seals (fig. 155).

(1) **INSPECT BEARINGS.** The condition of a bearing is best determined by the surface condition of the rollers and races. Inspect for wear or pits caused by corrosion. Inspect for discoloration of the rollers or cups, as this is evidence of overheating. Bearings that have been overheated, pitted or worn must be discarded. Spinning a bearing while holding it in the hands is not an accurate check for its running qualities, although this test will indicate the presence of dirt or foreign matter, and the bearing should be rewashed, lubricated and checked again.

(2) **INSPECT BEARING SEALS.** If a bearing seal is removed from the hub for any reason, always install a new seal.

(3) **REPLACE BEARING CUPS.** If a bearing cup is to be replaced, use a drift to drive the cup out of the hub. Keep moving the drift around the entire circumference of the cup, and drive the cup out slowly. Position a new cup in the hub. Use a cup drift, and drive the cup into the hub until it seats against the shoulder in the hub.

e. Assembly and Installation (fig. 155).

(1) **INSTALL IDLER SHAFT BRACKET AND SHAFT.** Position the bracket on the hull, and install the attaching cap screws (fig. 154). Enter the idler shaft into the bracket. Slide the collar on the hexagon end of the shaft, and install the cotter pin.

(2) **INSTALL INNER BEARING CONE AND SEAL.** Pack the inner bearing cone with general purpose grease, and install the cone in the hub. Position the seal in the hub with the flat side of the seal case out. Use a seal drift, and drive the seal into the hub, until the flat side of the seal case is flush with the end of the hub (fig. 158).

(3) **INSTALL WHEEL AND HUB ASSEMBLY ON SHAFT.** Slide the hub onto the shaft. Pack the outer bearing cone with general purpose grease. Install the bearing cone and thrust washer. Screw the inner bearing nut on the idler shaft until the bearing cones are seated, but not sufficiently to cause a bind.

(4) **ADJUST BEARINGS.** Turn the wheel by hand to determine the amount of drag caused by the bearing seal. Tighten the bearing nut until a slight increase in drag is felt when the wheel is turned. Turn the bearing nut one-quarter turn.

TANK, MEDIUM, M4A3

(5) **INSTALL NUT LOCK, OUTER BEARING NUT, HUB CAP AND GASKET.** Install the nut lock, and bend a tongue into one of the slots in the inner bearing nut. Screw the outer bearing nut onto the shaft. Tighten the nut with 200 to 300 foot-pounds of torque, and bend a tongue of the lock washer into one of the slots in the outer bearing nut. If a tongue does not line up with the slot in the outer nut, continue to tighten (do not back off the nut) until a tongue aligns with the slot. Install the gasket and hub cap with the attaching cap screws. Fill the hub with grease through the lubricant fitting in the hub cap until grease appears at the seal or relief fitting in the center of the hub.

(6) **INSTALL TRACK.** See paragraph 125 c.

(7) **ADJUST TRACK TENSION.** See paragraph 125 d (3).

127. DUAL SUPPORT ROLLERS.

a. **General.** Due to the center guide in the track, only the outer wheel of the dual track support rollers can be removed without disconnecting the track.

(1) **RELEASE TRACK TENSION.** See paragraph 125 d (2).

(2) **DISCONNECT TRACK.** See paragraph 125 b.

(3) **DISASSEMBLE ROLLERS** (fig. 156). Take out the cap screws that attach the hub cap to the hub, and remove the cap and gasket. Pry the nut lock tongue out of the recess in the nut, and unscrew the nut. Remove the nut lock and thrust washer. Pull the hub off the bracket shaft. Remove the outer bearing cone, seal and inner bearing cone from the hub.

b. **Cleaning and Inspection.** See paragraph 126 c and d.

c. **Assembly and Installation.**

(1) **ASSEMBLE SUPPORT ROLLER** (fig. 156). Pack the bearing cones with general purpose grease and install the inner cone. Position the seal in the hub with the flat side of the seal case out. Press the seal into the hub until the flat side of the seal case is flush with the end of the hub (fig. 158). Slide the hub onto the bracket shaft and install the outer bearing cone, thrust washer, nut lock and nut. Tighten the nut sufficiently to seat the bearing cones in the cups, but not tight enough to cause a bind in the bearings.

(2) **ADJUST BEARINGS.** See paragraph 126 e (4).

(3) **INSTALL HUB CAP.** Bend a tongue of the lock into one of the slots in the bearing nut. Attach the gasket and hub cap to the hub with the cap screws. Fill the hub with grease through the lubrication fitting on the hub cap until grease appears at the seal or relief fitting in the center of the hub.

HORIZONTAL VOLUTE SPRING, SUSPENSION AND TRACKS

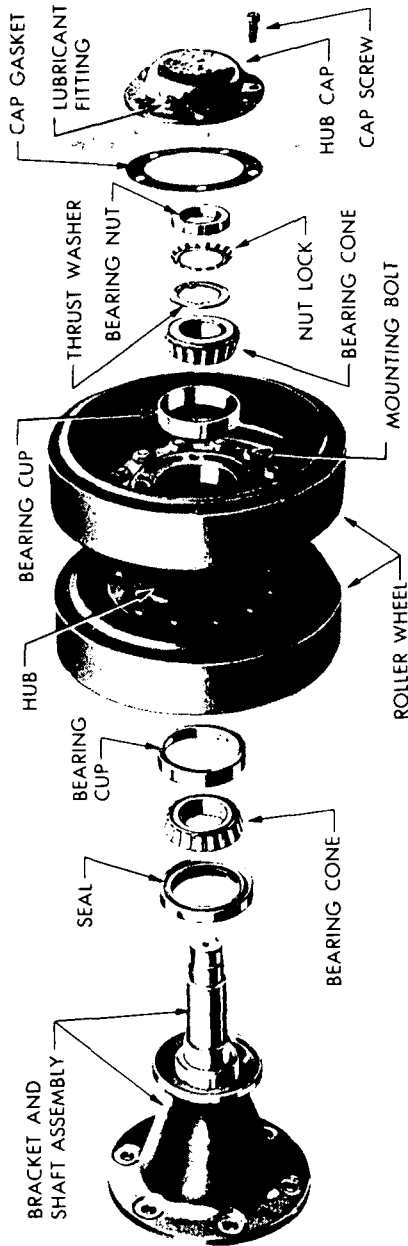

TANK, MEDIUM, M4A3

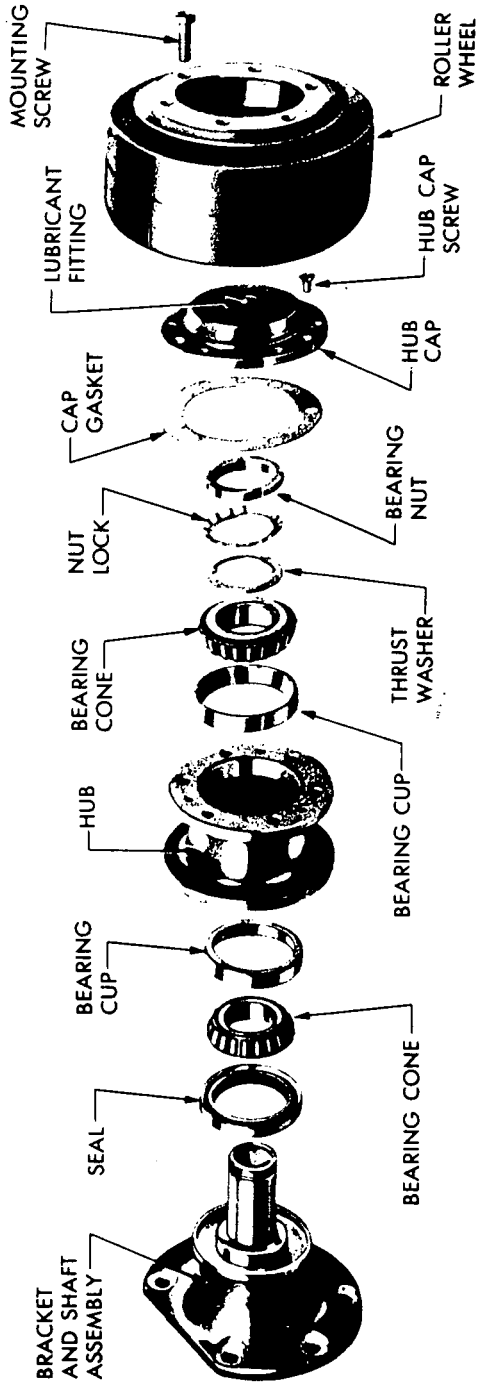

318

RA PD 313250

Figure 157—Single Roller Disassembled

HORIZONTAL VOLUTE SPRING, SUSPENSION AND TRACKS**128. SINGLE SUPPORT ROLLERS.**

a. **Removal and Disassembly.** See subparagraph (3) below.

(1) **RELEASE TRACK TENSION.** See paragraph 125 d (2).

(2) **DISCONNECT TRACK.** See paragraph 125 b.

(3) **DISASSEMBLE ROLLER WHEEL** (fig. 157). Take out the cap screws that attach the roller wheel to the hub and pull off the roller wheel. Take out the countersunk head screws that attach the hub cap to the hub and remove the cap and gasket. Pry the nut lock tongue out of the recess in the nut and unscrew the nut. Remove the nut lock and thrust washer. Pull the hub off the bracket shaft. Remove the outer bearing cone, seal and inner bearing cone from the hub.

b. **Cleaning and Inspection.** See paragraph 126 c and d.

c. **Assembly and Installation.**

(1) **ASSEMBLE SUPPORT ROLLER HUB** (fig. 157). Pack the bearing cones with general purpose grease, and install the inner cone. Position the oil seal in the hub with the flat side of the seal case out. Drive the seal into the hub with a driver until the flat side of the seal case is flush with the end of the hub (fig. 158). Slide the hub onto the bracket shaft and install the outer bearing cone, thrust washer, nut lock and nut. Tighten the nut sufficiently to seat the bearing cones in the cups, but not tight enough to cause a bind in the bearings.

(2) **ADJUST BEARINGS.** See paragraph 126 e (4).

(3) **INSTALL ROLLER WHEEL** (par. 126 e (3)). Depress a tongue of the lock washer into the recess in the nut. Attach the hub cap and gasket to the hub with the countersunk screws. Position the roller wheel on the hub, and attach with the cap screws. Fill the hub with grease through the lubricant fitting in the hub cap until grease appears at the seal or relief fitting (G103-03-01390) at the inner end of the hub.

129. DRIVE SPROCKETS.

a. **Description.** The drive sprockets are bolted to hubs, which in turn are attached to the flanged end of the final drive sprocket shaft with studs, dowels and nuts. The sprockets are interchangeable.

b. **Removal.**

(1) **RELEASE TRACK TENSION.** See paragraph 125 d (2)

(2) **DISCONNECT TRACK.** See paragraph 125 b.

(3) **REMOVE SPROCKETS.** Remove the nuts that attach the sprocket hub to the drive shaft. Pull the hub and dowels (G104-04-

TANK, MEDIUM, M4A3

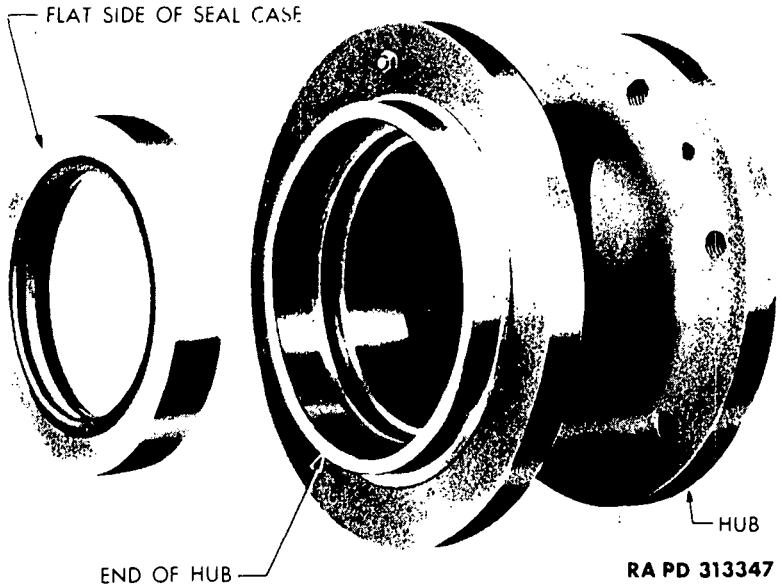

Figure 158—Oil Seal and Hub

00550) off the studs. Remove the nuts and take out the bolts (G104-15-24212) that attach the sprocket to the hub and remove the sprocket.

c. Installation.

(1) **INSTALL SPROCKETS.** Position the sprockets on the hub. Install the bolts and tighten with 140-foot-pounds of torque. Hold the heads of the bolts with a wrench, install and tighten the nuts to 100 foot-pounds torque. Mount the hub and dowels on the drive shaft studs. Install the attaching nuts and tighten securely.

(2) **CONNECT TRACK.** See paragraph 125 c (2).

(3) **ADJUST TRACK TENSION.** See paragraph 125 d.

130. SHOCK ABSORBERS.

a. **Description** (fig. 159). A telescopic-type hydraulic shock absorber is attached to each of the six horizontal suspension assemblies. A filler hole is provided in the reservoir for adding fluid when required. The fluid capacity of the shock absorbers is 70 ounces. If the shock absorbers do not become warm when the vehicle is being operated, it is an indication that the fluid is low, or that the shock absorber is not functioning.

HORIZONTAL VOLUTE SPRING, SUSPENSION AND TRACKS

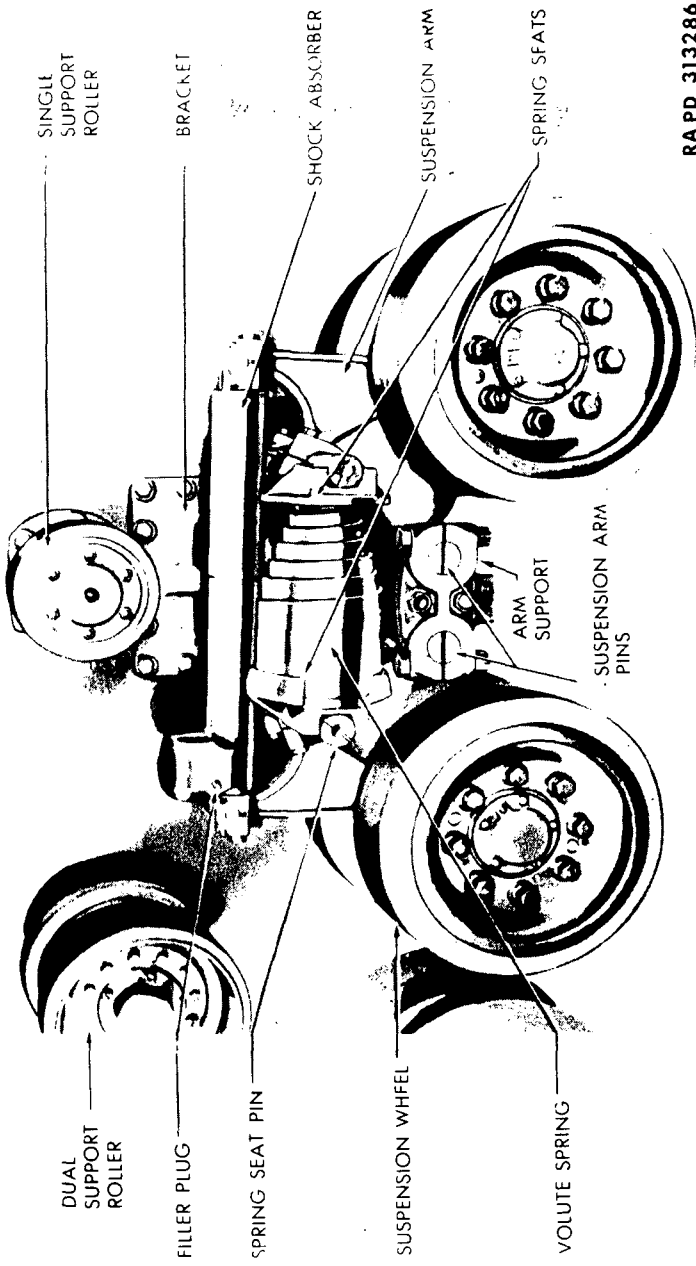

Figure 159—Suspension Assembly Installed

TANK, MEDIUM, M4A3

h. Removal. See paragraph 131 c (1).

c. Installation. See paragraph 131 c (2).

d. Filling Shock Absorber on Vehicle. Ordinarily the shock absorbers will not require filling after the vehicle has been put in operation. If leakage is apparent, replace the assembly. If filling is necessary as a temporary expedient, proceed as follows:

(1) Place the vehicle so that the shock absorber is approximately horizontal and near midstroke. Clean off all mud and dirt at the reservoir filler plug, and remove the plug. **CAUTION: Exercise extreme care to prevent dirt entering the filler plug opening.**

(2) Fill the reservoir with shock absorber fluid to the level of the plug opening (fig. 159) and install the plug, using a new gasket if necessary.

(3) If the loss of the fluid has been excessive, operate the vehicle over rough terrain to fill the shock absorber cylinder with fluid. Then repeat steps (1) and (2) above, and add more fluid if required.

131. SUSPENSION ASSEMBLY.

a. Description (fig. 159). The forward support arms on the front suspensions and the rear arms on the rear suspensions are provided with stops. The stops limit the downward movement of the arms, therefore these arms are not interchangeable with the other support arms.

b. Removal and Installation of Suspension Wheels.

(1) **REMOVE INNER SUSPENSION WHEEL.** Place the vehicle on level terrain. Lay a block one-inch thick on the track ahead of or behind the outer wheel. Move the vehicle until the outer wheel rests on the block. Take out the mounting screws and remove the wheel. In some instances, such as when the vehicle is fully loaded, it may be necessary to place a jack under the hull and raise the hull, to provide the necessary clearance for removal of the inner wheel.

(2) **INSTALL INNER SUSPENSION WHEEL.** Mount the wheel on the pilots in the hub. Install the mounting screws and tighten securely. Move the vehicle and remove the block.

(3) **REMOVE OUTER SUSPENSION WHEEL.** Place the vehicle on level terrain. Lay a block one-inch thick ahead or behind the inner wheel. Move the vehicle until the inner wheel rests on the block. Take out the mounting screws and remove the outer wheel.

(4) **INSTALL OUTER SUSPENSION WHEEL.** Follow the procedure outlined in step (2) above.

(5) **REMOVE BOTH INNER AND OUTER SUSPENSION WHEELS.** Remove outer wheel (step (3) above). Place a jack under the c

HORIZONTAL VOLUTE SPRING, SUSPENSION AND TRACKS

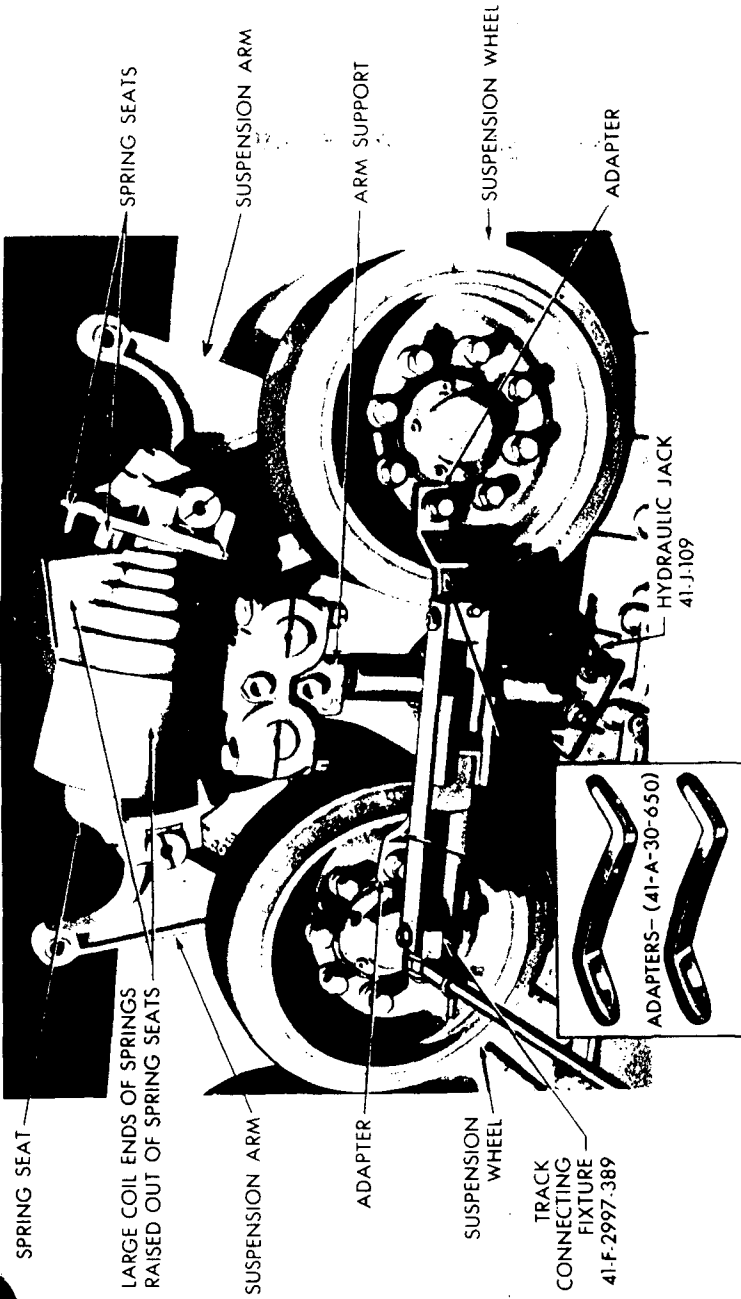

RA PD 313253

Figure 160—Removing or Installing Volute Springs

TANK, MEDIUM, M4A3

hub and raise the suspension arm just high enough to remove the block under the inner wheel. Take out the mounting screws and remove the inner wheel. In some instances, such as when the vehicle is fully loaded, it may be necessary to jack up the hull to provide clearance for removal of the wheel.

(6) **INSTALL BOTH INNER AND OUTER SUSPENSION WHEELS.** Install inner suspension wheel (step (2) above). Place a block one inch thick under the inner wheel and remove the jack under the outer hub. Install the outer wheel in the same manner as described in step (2) above.

c. Replacement of Volute Springs (fig. 160).

(1) **REMOVE VOLUTE SPRINGS.** Remove the shock absorber clamp bolts. Remove the shock absorber pins and lift off the shock absorber. Place a 30-ton jack under arm support and raise the suspension assembly until the suspension wheels are clear of the lower portion of track. *NOTE: When removing the springs from either front or rear suspension assembly, place a 30-ton jack under center suspension assembly, and release track tension (par. 125 d (2)).* Remove one mounting screw from each suspension wheel and attach adapters to wheels. Attach track connecting fixture to adapters and draw the wheels together. Insert a pry bar between the arm support and large coil end of the spring and pry the spring up until it is clear of seat, then lift out the spring.

(2) **INSTALL VOLUTE SPRINGS (fig. 160).** Enter the small coil end of each spring on the pilot and force the other end of each spring into position in spring seat. Release the tension on the track connecting fixture and remove the fixture and adapters from the suspension wheels. Remove the jack. Position the shock absorber on the suspension arms, with the reservoir filler plug to the outside, install the pins and tighten the clamp screws.

(3) **ADJUST TRACK TENSION.** See paragraph 125 d (3).

d. Disassembly.

(1) **RELEASE TRACK TENSION.** See paragraph 125 d (2).

(2) **REMOVE SHOCK ABSORBERS, SPRINGS AND SPRING SEATS.** Remove springs (subpar. c (1) above). Lift out the spring seats. Loosen the spring seat pin clamp bolts, and remove the pin (fig. 161). Remove the other spring seat pin in the same manner.

(3) **REMOVE SUSPENSION ARMS AND HUB ASSEMBLY (fig. 162).** Take out the suspension wheel mounting screws, and remove the wheels. Remove the four suspension arm pin clamp bolts. Remove the suspension arm support screws and the support. Pull the inner end of the suspension arm pin out of the bracket, and remove the arm and pin assembly. Remove the other arm in the same manner.

HORIZONTAL VOLUTE SPRING, SUSPENSION AND TRACKS

SPRING SEAT PIN

CLAMP BOLTS

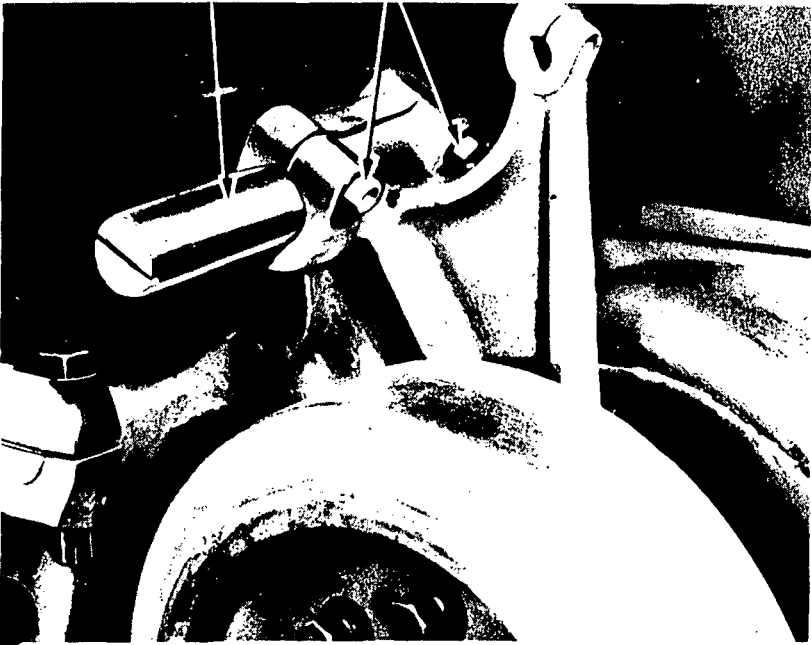

RA PD 341208

Figure 161—Removing Spring Seat Pin

(4) REMOVE SUSPENSION BRACKET (fig. 163). Take out the cap screws that attach the bracket to the hull, and remove the bracket.

(5) DISASSEMBLE HUB (fig. 162). Take out the attaching screws, and remove the hub cap and gasket. Pry the nut lock tongue out of the wheel outer bearing nut. Remove the nut and the nut lock. Unscrew the wheel inner bearing nut, and remove the thrust washer. Pull the hub off the wheel shaft. Remove the outer and inner bearing cones and seal. Disassemble the other hubs in the same manner.

e. Inspection and Repair of Parts.

(1) CLEAN PARTS. See paragraph 126 c.

(2) INSPECT BEARINGS AND SEALS. See paragraph 126 d.

(3) INSPECT OTHER PARTS (fig. 162). If a suspension bracket is cracked or twisted, replace the bracket. Replace the suspension arm assembly if cracked or twisted. If a suspension arm pin or a wheel nut is bent or loose in the arm, replace the arm assembly. If the

TANK, MEDIUM, M4A3

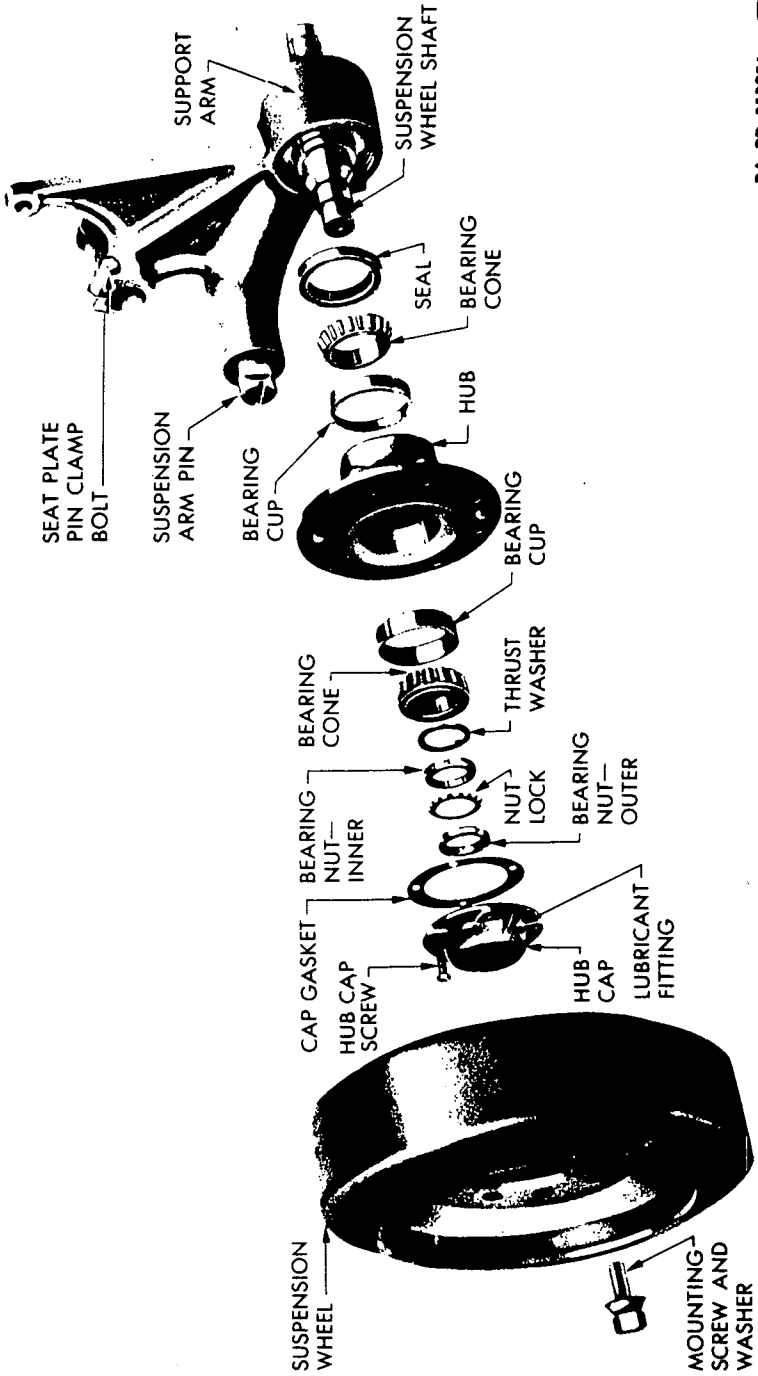

Figure 162—Suspension Wheel Support Arm Disassembled

RA PD 313256

HORIZONTAL VOLUTE SPRING, SUSPENSION AND TRACKS

spring seat plates are worn excessively, turn the plates over or install new plates. Replace the springs if cracked or broken or if they measure less than 13 inches in length. Replace the spring seat pins if badly worn or bent. If the shock absorber pins or bushings are worn, replace the bushings and pins.

f. Assembly.

(1) **INSTALL INNER BEARING CONE AND SEAL** (fig. 162). Pack the inner bearing cone with general purpose grease, and install the cone in the hub. Position the seal in the hub with the flat side of the seal case out (fig. 158). Use a seal drift, and drive the seal into the hub until the flat side of the seal case is flush with the end of the hub.

(2) **INSTALL HUBS** (fig. 162). Slide the hub onto the shaft. Pack the outer bearing cone with general purpose grease. Install the bearing cone and thrust washer. Screw the bearing inner nut on the shaft until the bearing cones are seated, but not sufficiently to cause a bind in the bearings.

(3) **ADJUST BEARINGS**. See paragraph 126 e (4).

(4) **INSTALL NUT LOCK, BEARING OUTER NUT, HUB CAP AND GASKET**. (fig. 162). Install the nut lock, and bend a tongue into one of the slots in the bearing inner nut. Screw the bearing outer nut onto the shaft. Tighten the nut to 200 foot-pounds torque, and bend a tongue into one of the slots in the nut. If a tongue does not line up with a slot in the outer nut, continue to tighten (do not back off the nut) until a tongue aligns with the slot. Install the gasket (G104-03-02310) and hub cap with the attaching screws. Fill the hub with grease through the lubricant fitting in the hub cap until grease appears at the seal or relief fitting in the center of the hub.

(5) **INSTALL SUSPENSION BRACKET** (fig. 163). Position the bracket on the hull. Support the bracket with a jack. Install the attaching 1-inch floor bolts and tighten securely. Then install the attaching $\frac{3}{4}$ -inch side bolts and tighten securely.

(6) **INSTALL SUSPENSION ARMS** (fig. 163). Raise the arm into position on the bracket and insert the rear end of the suspension arm pin into the bracket. Install the other arm in the same manner. Position the arm support on the suspension arm pins, and drive the support on the pins until it seats solidly on the end of the suspension bracket. Be sure the key on the end of the bracket is properly entered in the keyway in the arm support. Raise the arm support with a jack until it seats solidly against the bracket, install the support attaching screws and tighten securely. Align the slots on the outer ends of the suspension arm pins with the slots in the support. Install the clamp bolts, and tighten the nuts securely.

TANK, MEDIUM, M4A3

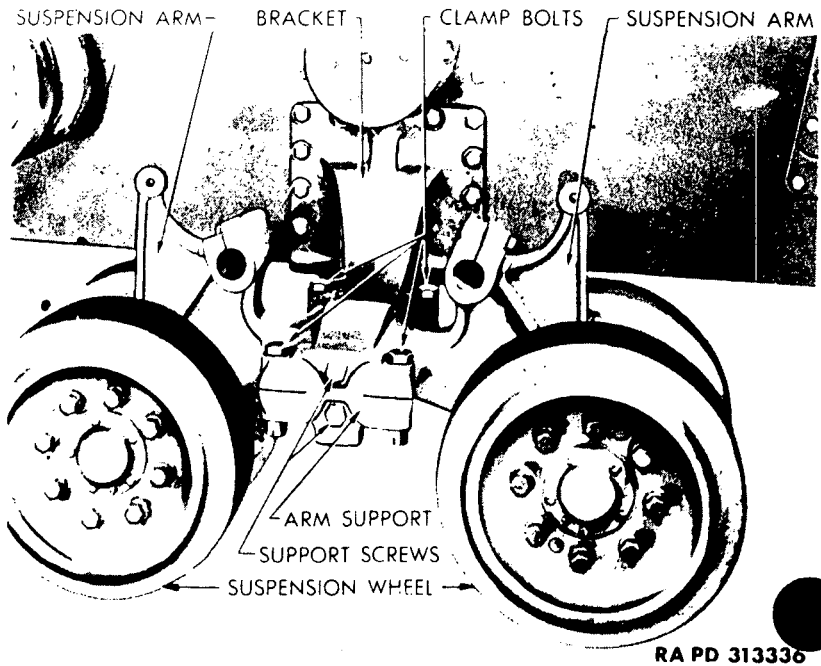

Figure 163—Suspension Arms and Wheels Installed

(7) **INSTALL WHEELS.** Install the wheels on the hubs and tighten the mounting screws securely.

(8) **INSTALL SPRINGS AND SHOCK ABSORBERS** (fig. 159). Install the spring seat pins in the support arms. Be sure the pins are centered, so that both ends of the pin are an equal distance from the arm. Tighten the clamp bolts. Position the spring seats on the spring seat pins. Install the springs and shock absorber.

(9) **ADJUST TRACK TENSION.** See paragraph 125 d (3).

Section XXIV

VERTICAL VOLUTE SPRING, SUSPENSION AND TRACKS

132. DESCRIPTION.

a. Two individually driven tracks propel the vehicle forward, backward (fig. 164). Each track is composed of 79 separate sh

VERTICAL VOLUTE SPRING, SUSPENSION AND TRACKS

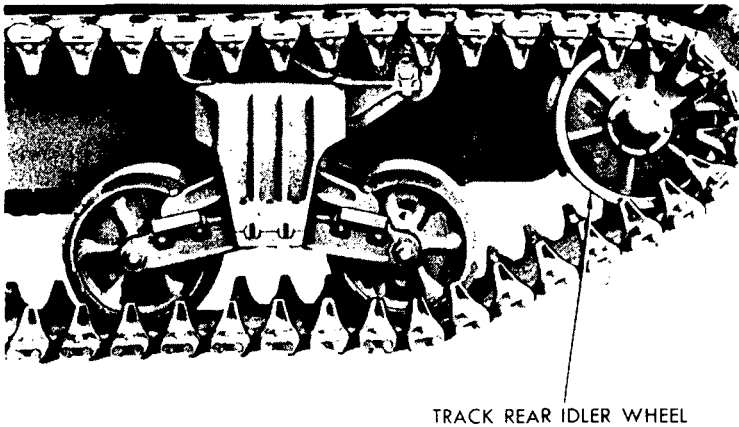
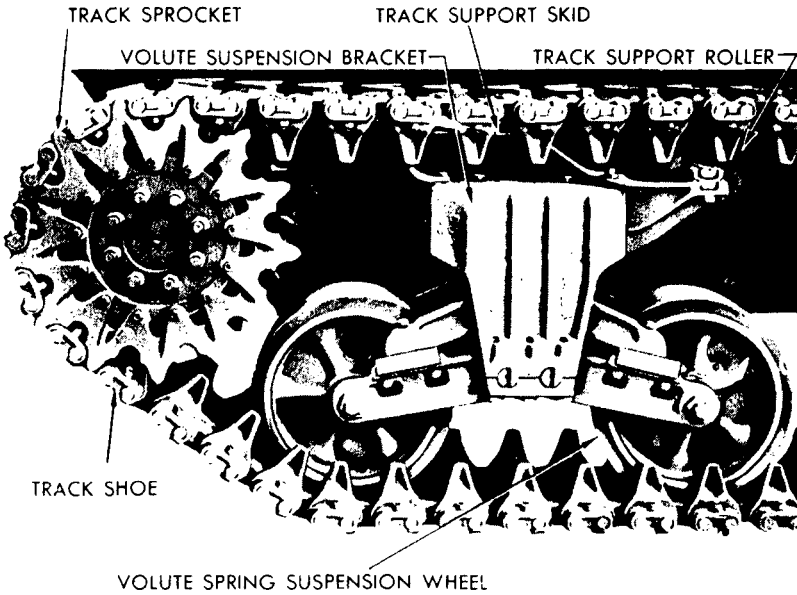

RA PD 312500

Figure 164—Vertical Volute Spring Suspension and Tracks

TANK, MEDIUM, M4A3

The tank is supported on six bogie suspension assemblies bolted to the hull. Each suspension has two rubber-tired wheels. As the tank passes over uneven ground, the vertical movement of the suspension wheels is transferred to the supporting arms or levers, and is absorbed by the two volute springs in each suspension assembly. Two drive sprockets at the front end of the vehicle pull the tracks from the rear, and lay them down in front of the advancing suspension wheels. A track skid (G104-23-86584) and a single steel roller are mounted at the top of each suspension to support and carry the upper portion of the track. An adjustable idler wheel for each track is mounted at the rear of the vehicle for adjusting tension of the tracks.

133. TRACKS.

a. Track Removal. With the vehicle on level terrain, so that it can be moved as required, remove track sand shields. Release the track tension at the idler adjustment (subpar. d (1) below). Break the track between the front suspension wheel and the sprocket. *NOTE: If the track has been thrown, break the track underneath either the idler or the sprocket, depending on which end of the track has the least twist.* Remove the wedge nuts and the wedges (G104-03-07761) and drive off the connectors (G104-03-01488). Lay the top half of the track on the ground to the rear of the vehicle.

b. Track Installation.

(1) **INSTALL TRACK** (fig. 165). If a new track or track section (G104-17-83067) or (G104-17-83069) is to be installed, lay it in front of, and in alignment with, the old track. If a thrown track is to be installed, dig a trench deep enough for the end of the track, so that the suspension wheel can roll directly onto the track. Tow the vehicle onto the track until about 16 inches of the end protrudes beyond the front suspension wheel. Block the suspension wheels in the track to prevent vehicle moving. Place the rear idler wheel in the extreme forward position, and lock the spindle in the bracket to prevent breakage of the idler bracket. Roll the end of the track over the idler wheel, and pull the track forward over the support rollers and sprocket with a cable attached to a towing unit.

(2) **CONNECT TRACK SHOES** (fig. 165). Attach the track connecting fixture to the ends of the track, and draw the ends together. Install connectors, wedges and wedge nuts. Remove the blocks from the suspension wheels.

(3) **ADJUST TRACK TENSION.** See subparagraph d below.

c. Dead Track Block Replacement (fig. 166).

(1) **REMOVE DEAD TRACK BLOCK.** Move tank so that the shoe to be replaced is midway between the idler wheel and the rear

VERTICAL VOLUTE SPRING, SUSPENSION AND TRACKS

TRACK ASSEMBLY

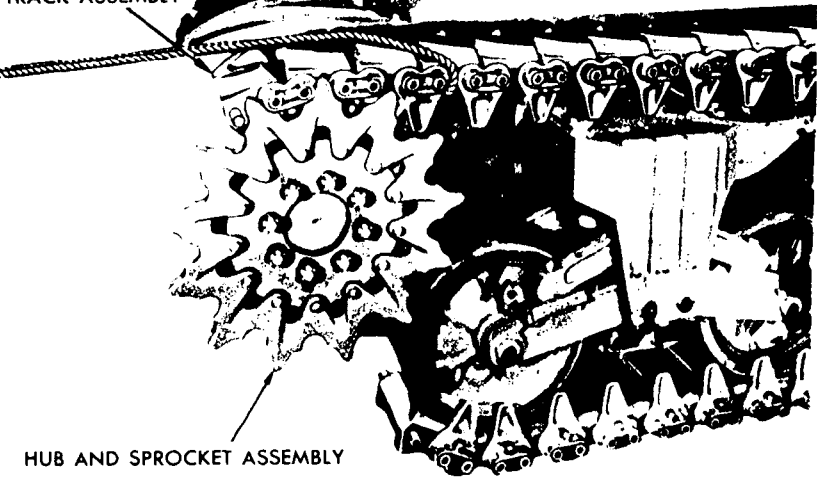

HUB AND SPROCKET ASSEMBLY



FIXTURE (41-F-2997-86)

RA PD 341209

Figure 165—Connecting Track

TANK, MEDIUM, M4A3

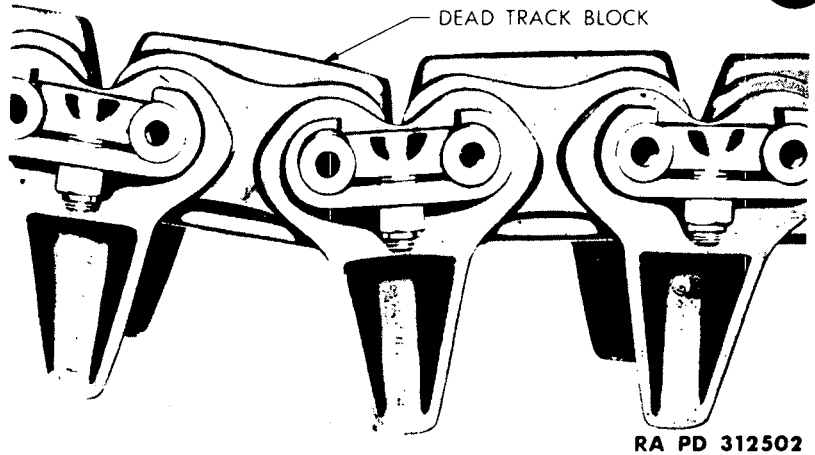

RA PD 312502

Figure 166—Dead Track Block

pension wheel. Release track tension at the idler adjustment (subpar. d (1) below). Remove the wedge nuts and wedges and drive off connectors.

(2) **INSTALL TRACK BLOCK.** Attach the new shoe to one end of the track. Connect track shoes with the track connecting fixture. Install connectors, wedges, and wedge nuts.

(3) **ADJUST TRACK TENSION AND LOCK IDLER ADJUSTMENT.** See subparagraph d below.

d. Track Tension Adjustment.

(1) **RELEASE IDLER LOCK** (fig. 167). Loosen the two outside clamping bolts in the idler wheel bracket. Turn the center bolt counterclockwise to spread the bracket until the spindle is free. **CAUTION: Excessive spreading will crack the bracket.** Place the adjusting wrench on the hexagon at the end of the spindle, and turn the spindle to release the bind on the collar. Raise the spring at the end of the bracket, and slide the collar off the serrations on the idler wheel spindle.

(2) **ADJUST TENSION** (fig. 167). Remove the sand shields over the rear suspension wheels. Lay a straightedge along the top of the track between the center and rear track supporting rollers. Use a piece of pipe on the handle of the adjusting wrench for leverage, and raise the handle of the wrench to tighten the track until there is 1/2- to 3/4-inch clearance between the straightedge and the top of the track, measured midway between the center and track rear support

VERTICAL VOLUTE SPRING, SUSPENSION AND TRACKS

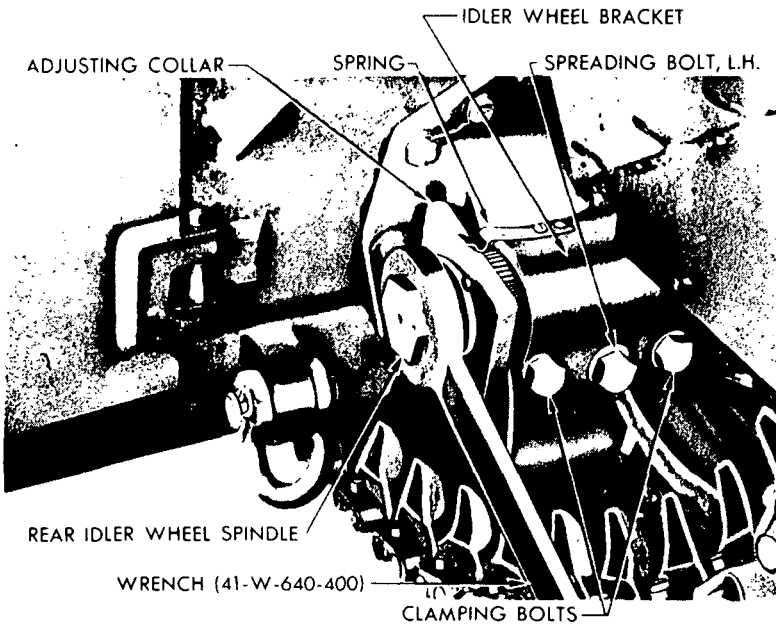
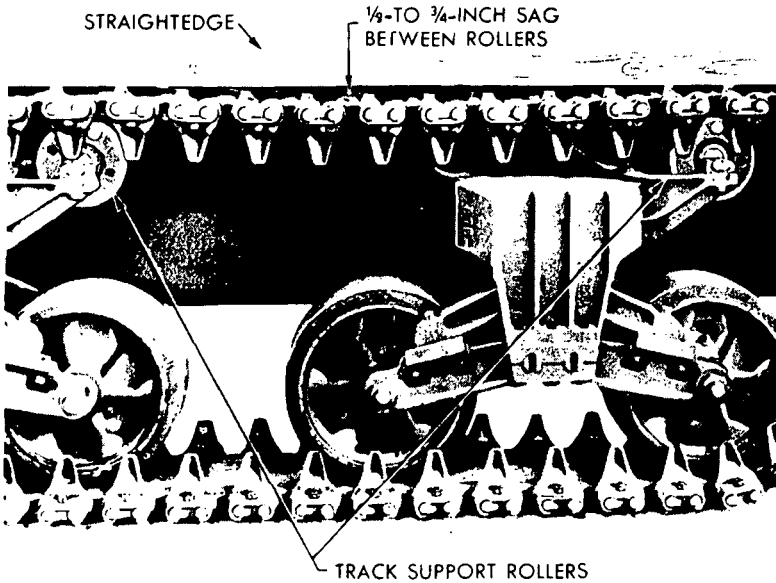

RA PD 312503

Figure 167—Adjusting Track Tension

TANK, MEDIUM, M4A3

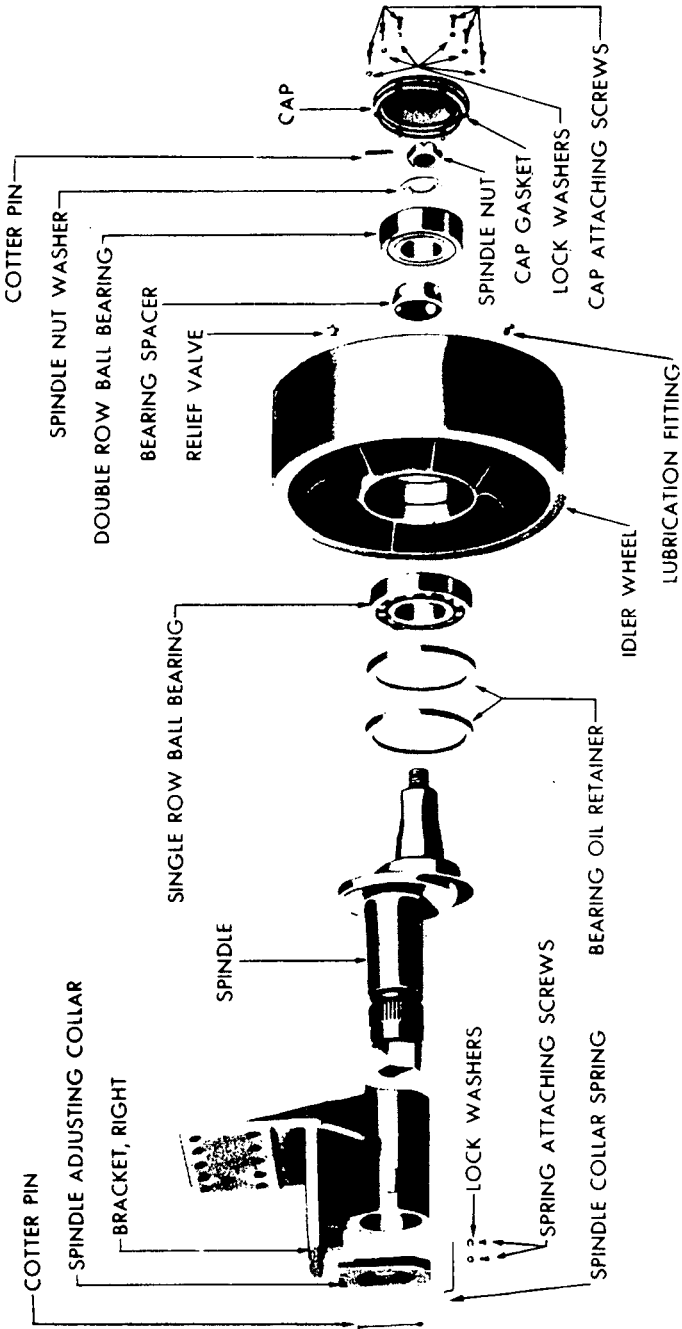

Figure 168—Idler Disassembled

VERTICAL VOLUTE SPRING, SUSPENSION AND TRACKS

Washers. Slide the collar plate back on and off the spindle when changing the wrench position.

(3) **LOCK IDLER ADJUSTMENT** (fig. 167). Slide the collar on the serrations of the spindle and lock it in place with the spring. Back out the center spreader bolt by turning it clockwise until it does not project through the split in the bracket. Tighten both outside clamping bolts securely, then tighten the center spreader bolt until it binds sufficiently to hold it from working loose. Remove the idler adjusting wrench. Install the sand shields.

e. Grousers.

(1) **DESCRIPTION.** Grousers are used with chevron-type rubber shoe tracks to give positive traction on slippery surfaces when the chevrons are worn off the shoes.

(2) **INSTALLATION.** Place the grouser over the track so that it is across the opening between two track shoes, and slide the two pins on the inside grouser end plate into the holes in the track shoe pins. Install the pins on the outside grouser end plate in the corresponding outer track shoe pins, and fasten the plate to the grouser with the special bolt and lock washer. Move the vehicle to install grousers on the lower part of the track.

4. TRACK IDLER WHEEL AND BRACKET.

a. Removal and Disassembly.

(1) **REMOVE TRACK.** See paragraph 133 a.

(2) **REMOVE IDLER WHEEL.** Remove the six cap screws in the idler wheel cap. Take out the cotter pin which secures the wheel nut, and remove the nut and washer. Pull the idler wheel (G104-03-0773) off the spindle with the idler wheel puller (41-P-29400-800).

(3) **REMOVE OIL RETAINERS AND BEARING** (fig. 168). Remove the outer idler wheel bearing and oil retainer with the bearing puller (41-P-29400-800). Remove the center bearing spacer. Drive out the inner idler wheel bearing and oil retainer.

(4) **CLEAN AND INSPECT PARTS.** Clean the hub of the idler wheel, bearings, and spacer. Inspect the bearings carefully for rough or broken balls, or cracked races. The bearing should spin freely without binding. Replace all damaged parts.

b. Assembly and Installation.

(1) **INSTALL OIL RETAINERS AND BEARINGS** (fig. 168). Pack the inner idler wheel bearing with grease (par. 29), and place the bearing in position in the hub. Drive the bearing into the hub with a drift until the bearing seats against the shoulder of the hub. Turn the idler wheel cover, and install the center bearing spacer. Pack the

TANK, MEDIUM, M4A3

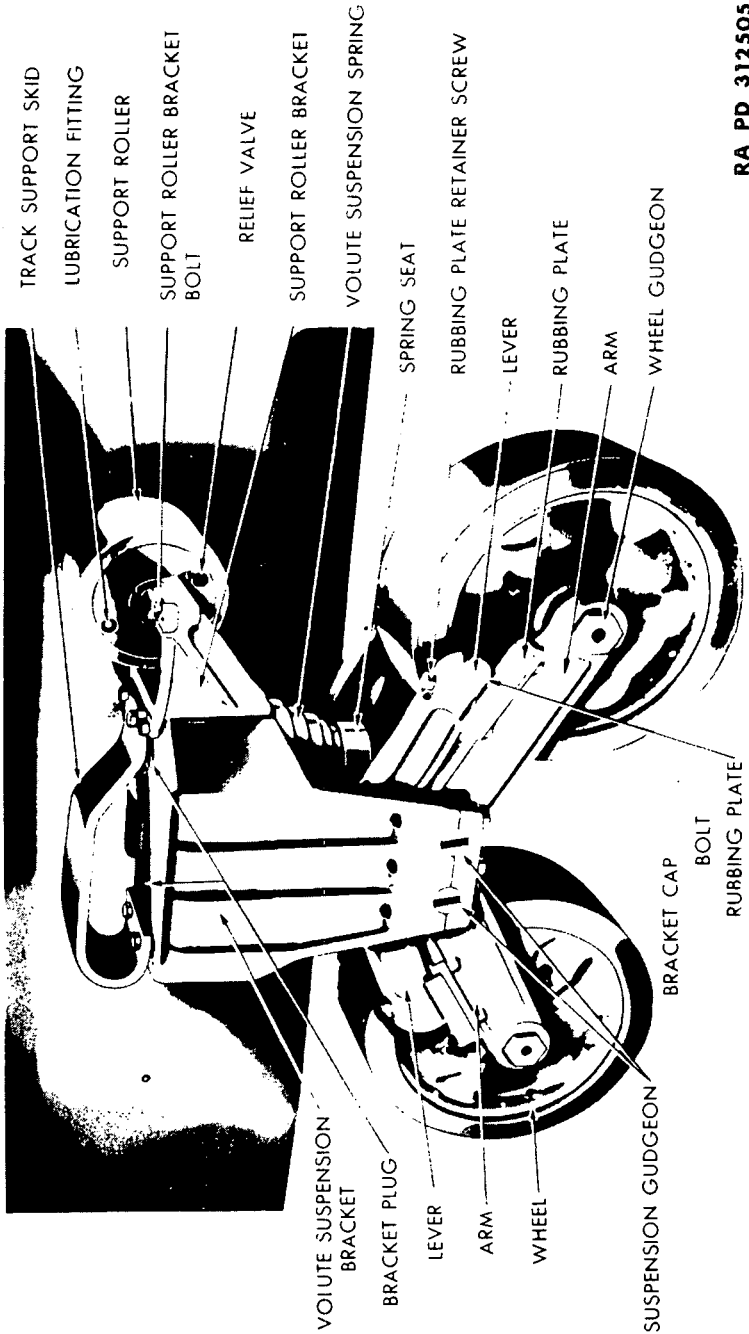

RA PD 312505

Figure 169—Volute S Suspension Assembly

VERTICAL VOLUTE SPRING, SUSPENSION AND TRACKS

the bearing with grease (par. 29), and drive the bearing into place in the hub with a drift. Install two new oil retainers on the spindle *with the lips of the retainers toward the shoulder of the spindle*. Place two shims (made from an old oil retainer) between the shoulder of the spindle and the oil retainer to force the oil retainer to the proper depth in the hub when the idler wheel is installed.

(2) **INSTALL TRACK IDLER WHEEL.** Place the idler wheel on the spindle. Screw the idler wheel installing tool (41-T-3216-150) on the spindle, and force the idler wheel onto the spindle. Remove the installing tool. Remove the locating shims between the shoulder of the spindle and the oil retainer. Install the washer and nut on the spindle, and tighten securely. Install cotter pin. Install the idler wheel cap and retainer screws.

(3) **INSTALL TRACK.** See paragraph 133 b.

(4) **ADJUST TRACK TENSION.** See paragraph 133 d (2).

c. Idler Wheel Bracket Removal.

(1) **RELEASE IDLER LOCK.** See paragraph 133 d (1).

(2) **DISCONNECT TRACKS AND REMOVE BRACKET.** Disconnect the track between the idler wheel and the rear suspension wheel. Remove the sand shields, and move the track toward the front of the vehicle until the end of the track is clear of the idler wheel. Remove the cotter pin from the hexagon end of the spindle, and slide the collar off the spindle. Pull the spindle and wheel out of the idler wheel bracket. Remove the cap screws that attach the bracket to the hull, and take off the bracket.

d. Idler Wheel Bracket Installation.

(1) **INSTALL BRACKET AND TRACK.** Attach the idler bracket to the hull with cap screws. Tighten the cap screws securely, and install the lock wires. Spread bracket and install the spindle and wheel in the idler wheel bracket. Slide the collar on the serrated end of the spindle, and install the cotter pin in the hole in the spindle. Pull the track over the idler wheel.

(2) **CONNECT TRACK SHOES.** See paragraph 133 b (2).

(3) **ADJUST TRACK TENSION.** See paragraph 133 d (2).

135. TRACK SUPPORTING ROLLER AND BRACKET.

a. Removal (fig. 170). Remove sand shields. Remove the lock wires, take out the four cap screws that attach the track skid (G104-23-86584) to the top of the bogie frame, and raise the track sufficiently to take the weight off the roller (G104-03-05690). Remove the lock wires, take out the six cap screws and attach the roller bracket to the bogie frame, and remove the roller and bracket.

TANK, MEDIUM, M4A3

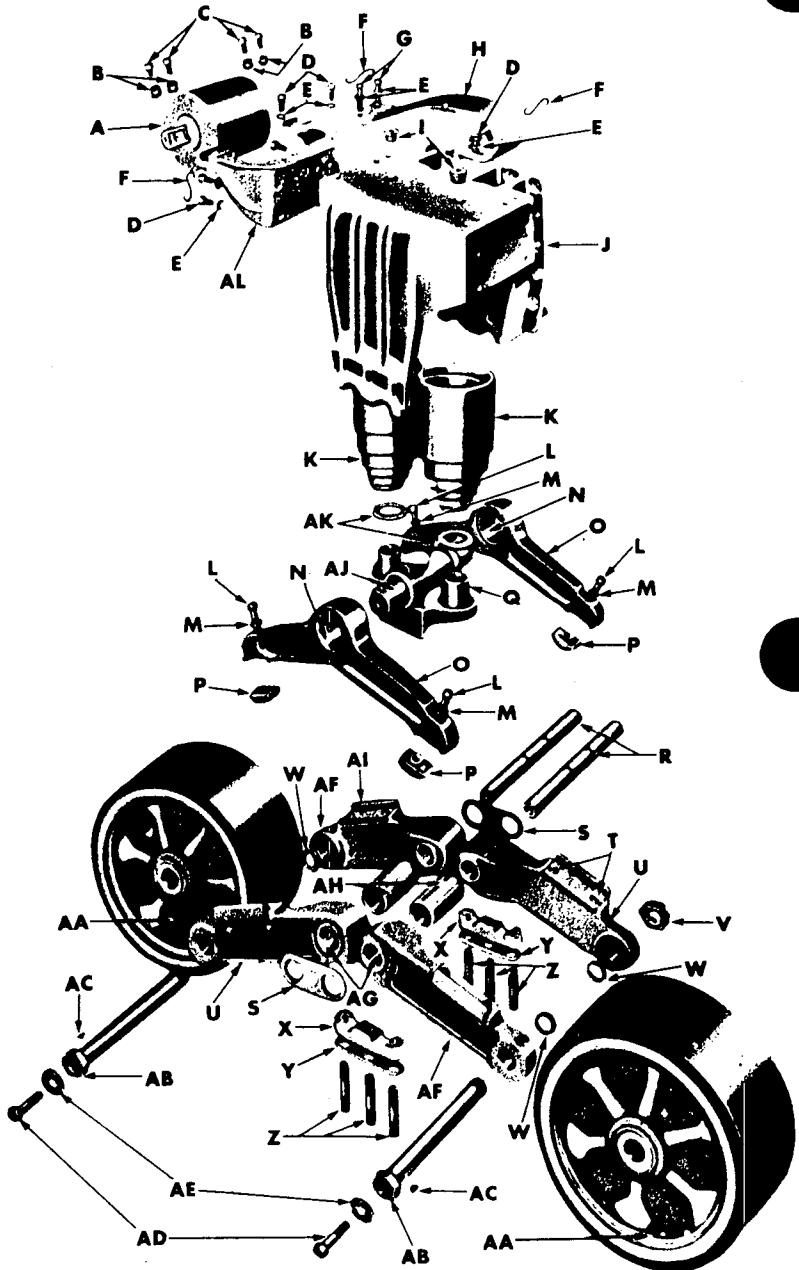

RA PD 53557

Figure 170—Volute Spring Suspension Assembly Disassembly

VERTICAL VOLUTE SPRING, SUSPENSION AND TRACKS

- | | |
|-------------------------------------|--|
| A —SUPPORT ROLLER ASSEMBLY | T —RUBBING PLATE SCREW |
| B —NUT | U —VOLUTE SUSPENSION ARM, LEFT |
| C —CAP SCREW | V —VOLUTE SUSPENSION GUDGEON NUT |
| D —CAP SCREW | W —WHEEL GUDGEON OIL SEAL |
| E —LOCK WASHER | X —VOLUTE SUSPENSION BRACKET CAP |
| F —LOCK WIRE | Y —VOLUTE SUSPENSION BRACKET CAP LOCK |
| G —CAP SCREW | Z —BRACKET CAP STUD |
| H —TRACK SUPPORT SKID | AA —VOLUTE SUSPENSION WHEEL ASSEMBLY |
| I —BRACKET PLUG | AB —WHEEL GUDGEON |
| J —VOLUTE SUSPENSION BRACKET | AC —WOODRUFF KEY |
| K —VOLUTE SUSPENSION SPRING | AD —WHEEL GUDGEON CAP SCREW |
| L —CAP SCREW | AE —LOCK WASHER |
| M —LOCK WASHER | AF —VOLUTE SUSPENSION ARM, RIGHT |
| N —LEVER BUSHING | AG —VOLUTE SUSPENSION BUSHING |
| O —LEVER | AH —VOLUTE SUSPENSION SPACER |
| P —RUBBING PLATE | AI —VOLUTE SUSPENSION RUBBING PLATE |
| Q —SPRING SEAT | AJ —SPRING SEAT BUSHING |
| R —SUSPENSION GUDGEON | AK —SPRING SEAT RING |
| S —VOLUTE SUSPENSION PLATE | AL —TRACK SUPPORT ROLLER BRACKET |

RA PD 53557B

Legend for Figure 170

TANK, MEDIUM, M4A3

Remove the lock wires and four cap screws that attach the roller shaft to the bracket, and lift roller and spacers from the bracket.

b. **Installation** (fig. 170). Place the roller and spacers in the support bracket, and install the four cap screws that attach the roller shaft to the bracket. Tighten cap screws securely, and install lock wires. Attach the roller bracket to the bogie frame with the six cap screws. Tighten cap screws securely and install lock wires. Remove the jack. Attach the track skid to the top of the bogie frame with the four cap screws. Tighten cap screws securely, and install lock wires.

136. SUSPENSION WHEELS, BEARINGS, AND OIL RETAINERS.

a. **General.** The forward suspension wheel under the drive sprocket on each track *cannot* be removed without disconnecting the track. The remainder of the suspension wheels *can* be removed without disconnecting the track.

b. **Removal and Disassembly.**

(1) **REMOVE SUSPENSION WHEEL** (fig. 171). Place the bogie lift (41-L-1375) on the track under the suspension arms to be lifted. Carefully drive the vehicle forward or backward, depending on the wheel to be lifted, until the lift is vertical and the wheel has been raised. If a forward wheel is being removed, release track tension (par. 133 d (1)), and break the track between front suspension wheel and drive sprocket. Remove the cotter pin from the nut (G104-23-15900) on the inner end of the wheel gudgeon (G104-22-05500) and remove the nut. Remove the plug in the head of the gudgeon pin. Pull out the gudgeon pin, and remove the wheel.

(2) **REMOVE OIL RETAINERS AND BEARINGS** (fig. 172). Support the wheel on its side on blocks. Move the bearing spacer located in the center of the hub between the bearings to one side. Use a drift seated on the outer bearing race to drive out the bearing, oil retainers, and outer spacer. Keep moving the drift around the entire circumference of the outer bearing race, and drive the bearing out evenly. Remove the inner spacer, turn the wheel over, and drive out the other bearing, oil retainers, and outer spacer.

c. **Assembly and Installation.**

(1) **INSTALL BEARINGS AND OIL RETAINERS** (fig. 172). Lay the wheel on its side. Pack the bearing with general purpose grease, and start the inner bearing into the hub by hand. Tap the bearing into place with the bearing installing drift (41-D-1463) until it seats against the shoulder in the hub. Install both the inner and

VERTICAL VOLUTE SPRING, SUSPENSION AND TRACKS

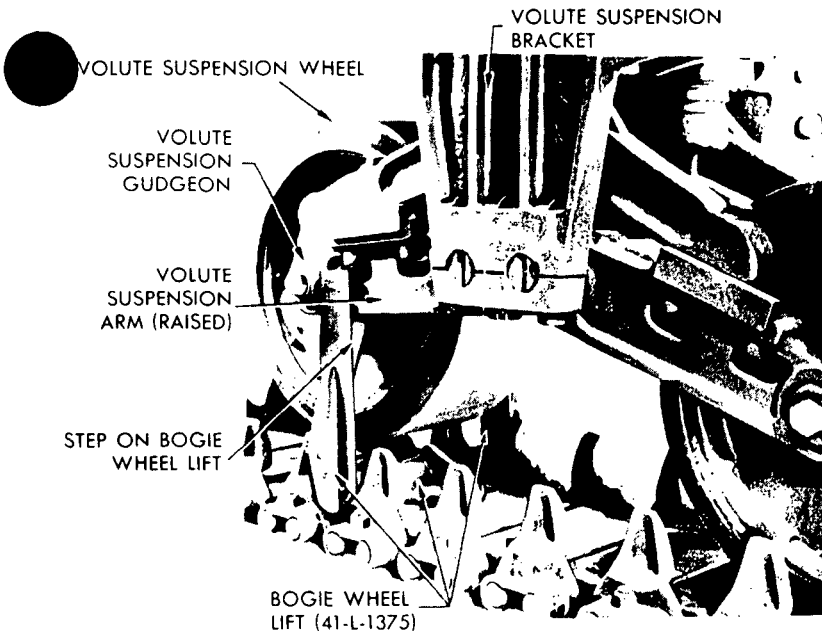
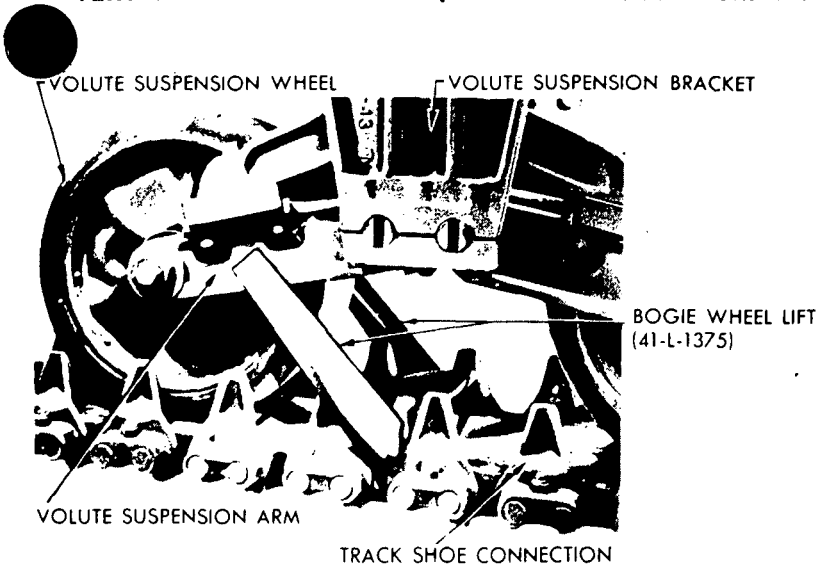

RA PD 312507

Figure 171—Raising Volute Suspension Wheel With Lift

TANK, MEDIUM, M4A3

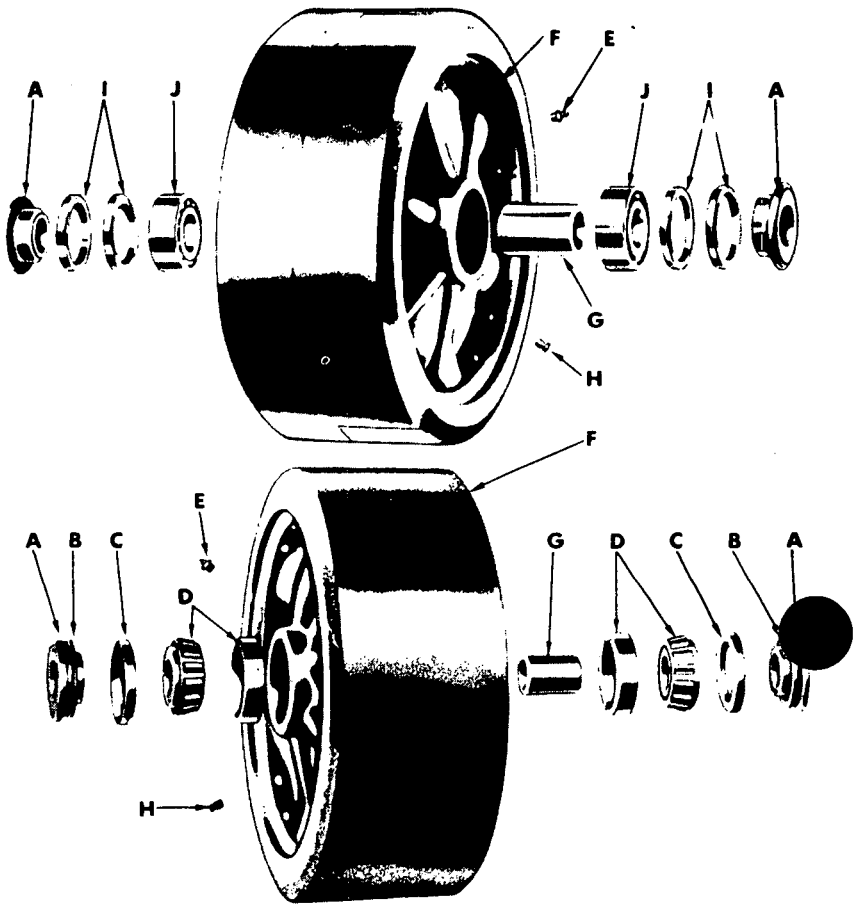

- A—BEARING SPACER, OUTER
- B—BEARING OIL SEAL
- C—BEARING OIL SEAL
BACKING PLATE
- D—ROLLER BEARING AND RACE
- E—LUBRICATION FITTING
- F—WHEEL AND TIRE ASSEMBLY
- G—BEARING SPACER, CENTER
- H—RELIEF FITTING
- I—BEARING OIL RETAINER
- J—DOUBLE ROW BALL BEARING

RA. PD 312508

Figure 172—Volute Suspension Wheel Disassembly

VERTICAL VOLUTE SPRING, SUSPENSION AND TRACKS

retainers on the outer spacer *with the lips of the retainers toward the shoulder of the spacer*. Start the spacer into the wheel hub, and tap the spacer into place with the drift. Turn the wheel over, and install the inner spacer. Pack the bearing with general purpose grease, and tap the bearing into place in the hub. Install the oil retainer on the outer spacer. Install spacer in wheel.

(2) **INSTALL SUSPENSION WHEEL.** Place the wheel, with lubrication fitting toward the outside of the vehicle, on the track between the arms. Aline the gudgeon hole in the arms and wheel. Install the plug in the hexagon end of the gudgeon pin, and start the gudgeon pin through the outer arms and into the outer spacer and wheel bearing. Line up the center spacer with a bar from the inner side of the wheel, and tap the gudgeon pin into the center spacer. Drive the gudgeon pin through far enough to aline the key slot in the gudgeon pin with the slot in the outer arm. Install the key, and drive the gudgeon pin all the way in. Install and tighten the nut on the inner end of the gudgeon pin, and secure with a cotter pin.

137. VOLUTE SPRING SUSPENSION.**a. Volute Suspension Assembly Removal.**

- (1) **RELEASE TRACK TENSION.** See paragraph 133 d (1).
- (2) **DISCONNECT TRACK.** Break the track between the idler wheel and rear suspension wheel. Remove the sand shields. Drive tank forward until the end of the top of the track clears the bogie to be removed. Set the hand brake to prevent the track moving.
- (3) **REMOVE VOLUTE SUSPENSION ASSEMBLY.** Remove all cap screws from volute suspension bracket. Jack up the tank hull so that the suspension wheel (G104-18-46950) will clear the track. Attach a hoist to the volute suspension, and lift out the assembly.

b. Volute Suspension Assembly Installation.

- (1) **INSTALL VOLUTE SUSPENSION ASSEMBLY.** Attach a hoist to the volute suspension, and lift the assembly into the track. Place a jack under the tank hull, and lift the side of the tank sufficiently to allow the foot of the bracket of the volute suspension to clear the bottom of the tank hull. Lower the hoist, and move the top of the assembly into position against the hull. Line up the mounting holes, and install cap screws or nuts.
- (2) **CONNECT TRACK.** Drive tank backward, and guide the track over the rollers with a bar or plank into position to be connected. Connect the track with track connecting fixture (fig. 165).
- (3) **ADJUST TRACK TENSION.** See paragraph 133 d (2)

c. Volute Spring Replacement (fig. 173)

- (1) **REMOVAL.** Place two 5-ton jacks beneath springs. Posi-

TANK, MEDIUM, M4A3

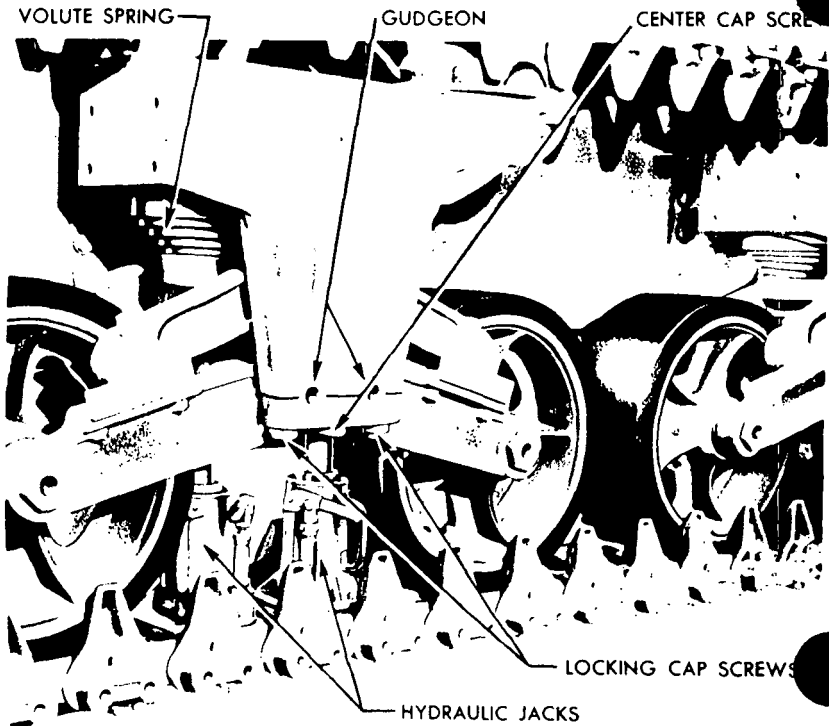

RA PD 28455

Figure 173—Changing Volute Spring

tion the jacks on the track so that the head of each jack is in the center of each end of the spring seat plate. In placing the jacks, arrange the blocking so that the jack plunger will be nearly at the upper end of its travel when the thrust of the springs is taken up, in order to permit a greater lowering travel later (fig. 173). Jack up seat plate. Raise each jack until the thrust of the spring has been taken up. Straighten the ears of locking plate, remove the two locking cap screws and loosen the center cap screw that secures the center gudgeon pins in the bogie bracket (fig. 173). Remove the bogie gudgeon pins. When the pins are pulled out, the bogie arms and gudgeon spacers will drop. Lower the jack with the spring seat plate and springs. If the jack has not sufficient travel to decompress the springs, push two bars through the gudgeon pin holes, and lower the spring seat plate onto the bars. Remove the blocking, or lower the adjustable screw onto the jack, and again raise the plate off the bars with the jack. Remove the bars, and continue to lower the jack and decompress the spring. If the spring seat p

HULL AND TURRET

and springs do not drop out on removal of the jack, free them with a hammer or wood block. **NOTE:** *Whenever a new volute spring is required, install two new springs, never one old and one new spring.*

(2) **INSTALLATION.** Place the springs and spring seat plate in position, and raise with the jacks until the springs are compressed sufficiently. Aline the bogie arms and spacer plates, and install the gudgeon pins, making sure that grooves are on the side to permit installation of the locking cap screws. Install the gudgeon locking cap screws, and secure the lock plate to the cap screw heads. Lower and remove the jacks, allowing the bogie levers to resume their normal position on the wheel arms.

d. **Rubbing Plate Replacement** (fig. 170). Place a pinch bar between the lever and arm to relieve the pressure on the rubbing plate. Insert a block between the arm and lever. Unscrew the rubbing plate retainer screw from the plate, install a new plate and tighten the screw securely. Remove the block from between the arm and lever with a pinch bar.

Section XXV

HULL AND TURRET

138. HULL.

a. **Description.** The hull of the vehicle is made of welded armor plate, and is divided into two sections by a bulkhead. The engine compartment is located in the rear section; the fighting compartment and driver's and assistant driver's stations are located in the front section.

b. **Wet Stowage.** Wet stowage is provided on some 75-mm vehicles and on all 76-mm vehicles. Wet stowage means that the ammunition racks are enclosed in a container filled with a solution to prevent fire. The container is filled through plugs located on the top of the container.

c. **Fender or Sand Shield Replacement.** Turn all of the screw head locks one-quarter of a turn counterclockwise on the fender or sand shield to be removed. Remove the nuts, bolts and bond washers that secure the fender or sand shield. Hold the fender or sand shield in place and install the nuts, bolts and bond washers. Push in on the screw head locks, and turn them one-quarter of a turn clockwise.

139. ESCAPE HATCH.

a. The escape hatch is located in the vehicle floor: back of the assistant driver's seat (fig. 175). The escape hatch is important to

TANK, MEDIUM, M4A3

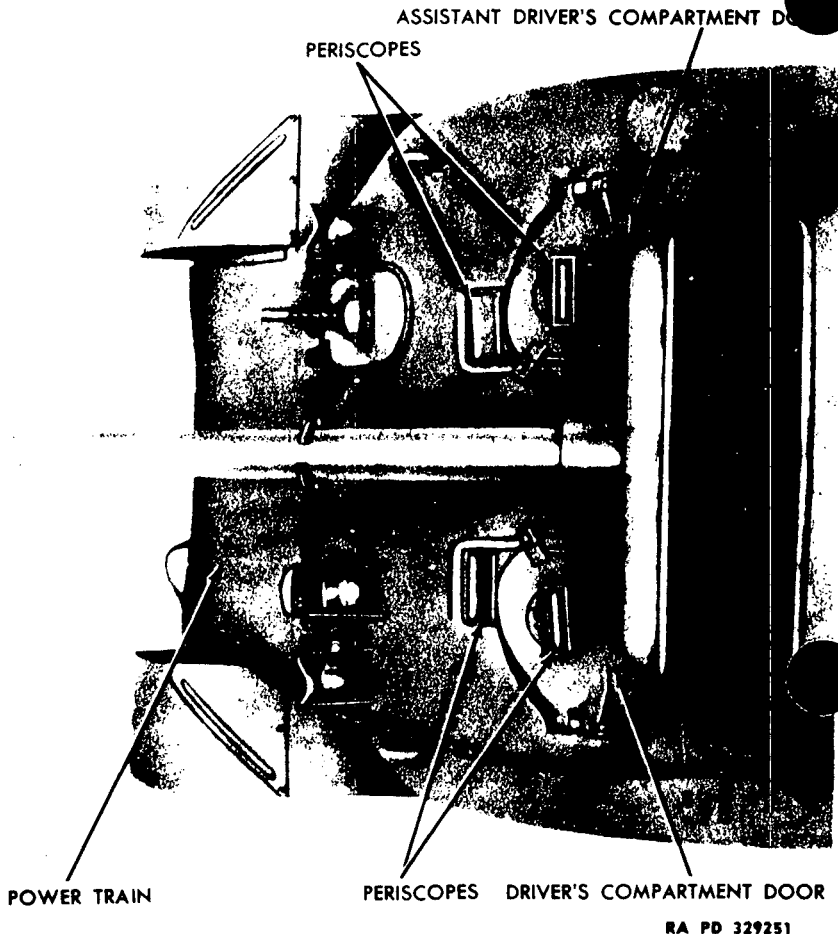

Figure 174—View of Driver's and Assistant Driver's Doors From Above

the safety of the crew, and should be checked frequently for ease of operation. It should be removed, cleansed of dirt and rust, and its working parts lubricated at regular intervals. Operation of the escape hatch is described in paragraph 12 h.

140. VISION DEVICES.

a. **Description.** A periscope is provided for each member of the crew at his station. The mounting for each periscope, except that of the gunner, includes a revolving plate which permits the periscope to be aimed in any position. A rotation set screw can be tightened to hold the periscope in any position desired. The periscope m

HULL AND TURRET

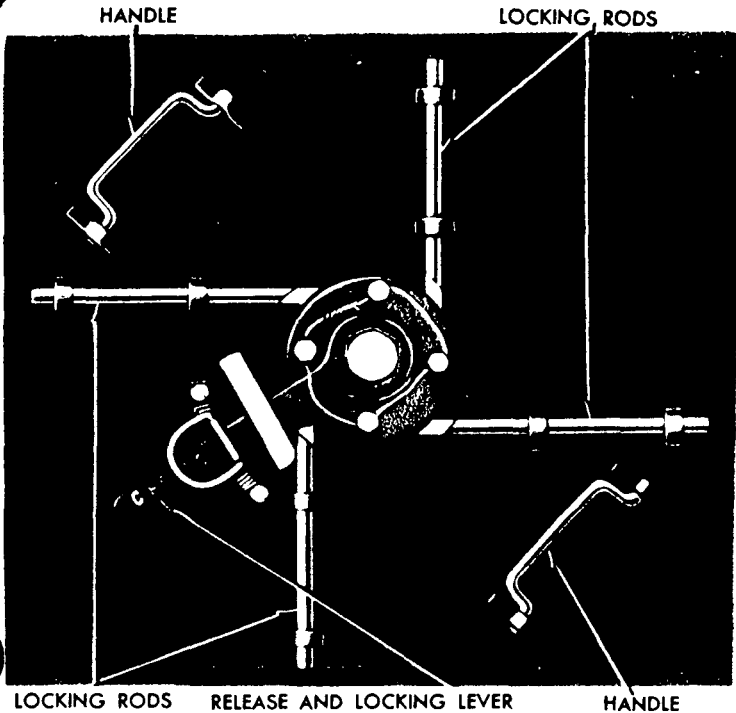

RA PD 329249

Figure 175—Escape Hatch

can be tilted to elevate the line of vision, and can be locked in place by a knurled nut on the back of the periscope. A safety lock prevents the periscope from falling out if the knurled nut becomes loosened.

b. **Periscope Replacement.** Slide the safety lock back, loosen the knurled nut, and remove the periscope. To install, insert the periscope in place, tighten the knurled nut, and secure with safety lock.

141. DRIVER'S AND ASSISTANT DRIVER'S HATCH DOORS.

a. **Description** (fig. 174). The driver's hatch doors, located at the front of the hull, permit entrance into the driver's and assistant driver's compartment. A periscope is mounted in each door on a ball-bearing race permitting a 360-degree rotation

b. **Removal.** Disconnect the assist spring on top of the door. Unscrew the plug in the rear hinge bearing, and remove the hinge. Remove the hatch door. This procedure applies to both doors.

TANK, MEDIUM, M4A3

c. **Installation.** Fit the door hinge section to the hull hinge section so that it does not bind in any position. Fit the hinge pin in the hinge so that the door will operate freely. Fill the space at the rear end of the hinge with oil, and screw the plugs tightly in place.

142. ENGINE COMPARTMENT DOORS.

a. **Description** (fig. 24). The engine compartment covers consist of a front cover, rear cover, and two doors. The engine compartment doors are mounted directly to the hull. The doors on later vehicles are provided with shutters under the grilles, and are controlled by a cable operated in the fighting compartment.

b. **Removal.** Remove the two bolts that secure each door at the lifting handles. Open both doors and, if equipped with shutters, disconnect both shutter control cables at the hinged ends of the doors. Remove the six bolts that secure each of the hinge plates to the hull. Remove the doors and hinge plates from the hull. Remove the cotter pin at each of the four hinges and remove the hinge pins. Remove the hinge plates from the two doors.

c. **Installation.** Place the hinge plate in place between the hinges on the door. Install the hinge pins and cotter pin. Place the door in position on the hull. Use a long-nosed drift to line up the holes in the hinge plate with the holes in the hull. Install the bolts that secure the hinge plate and door to the hull. If equipped with shutters, connect the shutter control cable at each door. Close both doors, and install the four bolts at the lifting handles.

143. PINTLE HOOK.

a. **Description.** A pintle hook is provided on the rear of the later vehicles for towing a trailer only. The pintle hook is attached to the hull by means of a large nut on the end of the pintle stud.

b. **Replacement.** Remove the cotter pin and castellated nut that secure the pintle hook to the bracket and remove the pintle hook. To install the pintle hook, position it in place on the bracket, and install the castellated nut and cotter pin.

144. TURRET.

a. **General.** The turret is a one-piece, armor-steel casting, rotating on a ball-bearing race, which is recessed and protected against direct hits and lead splash. The turret platform or basket is suspended from the turret by a ring of bolts around its top circumference.

b. **75-mm Dry Stowage Vehicles** (fig. 4). The 75-mm dry stowage vehicles are equipped with one turret hatch cover, which

HULL AND TURRET

ates through 360 degrees and mounts a 50-caliber gun. A turret basket is provided on all 75-mm dry stowage vehicles.

c. **75-mm Wet Stowage Vehicles (fig. 3).** The 75-mm wet stowage vehicles are equipped with two turret hatch covers, one which rotates through 360 degrees and mounts a 50-caliber gun, and also one hinge-type hatch cover, which is held open or closed by a spring-loaded latch. The turrets on the 75-mm wet stowage vehicles are equipped with a full-turret platform.

d. **76-mm Wet Stowage Vehicles (fig. 2).** The 76-mm wet stowage vehicles are equipped with a turret hatch cover which rotates through 360 degrees and mounts a 50-caliber gun. A cupola is also provided to insure better vision from inside the turret (fig. 2). A partial platform is provided in this type of turret for the gunner.

e. **105-mm Howitzer (fig. 5).** The turrets on all 105-mm howitzer vehicles are provided with a cupola and a hinge-type hatch cover. The 50-caliber gun mount is stationary on the turret.

145. CUPOLA VISION BLOCKS.

a. **Description.** Direct-vision blocks are provided in a cupola on the 76-mm wet stowage and 105-mm howitzer vehicles (figs. 2 and 5). The vision blocks are bulletproof, and are easily replaced.

b. **Replacement.** Remove the socket head set screw from each end of the vision block. Loosen the center socket head set screw and remove the vision block retainer and vision block. To install the vision block, hold the block in place and install the retainer and tighten the center socket head set screw. Install and tighten the two end socket head set screws.

146. GUN-TRAVELING LOCKS.

a. **Description.** The later M4A3 vehicles, with the exception of the 75-mm dry stowage vehicles, are equipped with a gun-traveling lock (figs. 2, 3, and 5). To release the gun from the gun-traveling lock, pull down on the release ring and at the same time raise the gun. To lock the gun in the gun-traveling lock, hold the gun-traveling lock jaws in a halfway open position and at the same time lower the gun into the gun-traveling lock.

b. **Replacement.** Drive the lock pin from the right-hand side of each bracket. Drive both hinge pins from the brackets and remove the gun-traveling lock. Position the gun-traveling lock in the brackets and install the two hinge pins, making sure the lock pin hole in the hinge pin is in line with the lock pin hole in each bracket. Install the lock pin in each bracket.

TANK, MEDIUM, M4A3**Section XXVI****TURRET TRAVERSING MECHANISM****147. GEAR MECHANISM AND MANUAL DRIVE REPLACEMENT.****a. Removal (figs. 176 and 177).**

(1) **GENERAL.** If working on a vehicle with the 105-mm howitzer, follow the procedure in step (4) below. On all other vehicles, follow the complete removal procedure (steps (2) through (4) below).

(2) **REMOVE TUBES FROM TRAVERSE MOTOR TO TRAVERSE PUMP AND OIL RESERVOIR** (fig. 177). Disconnect nut on elbow fitting in traverse pump port No. 2 and on motor port No. 1. Remove the tube. Drain the oil remaining in the tube into a rag. Disconnect nut on elbow fitting in motor port No. 3 and in port No. 14 in the oil reservoir. Remove the tube. Drain oil remaining in the tube into a rag. Disconnect nut on elbow fitting in traverse motor port No. 2 and in pump port No. 1. Remove the tube and drain the oil remaining in the tube into a rag.

(3) **REMOVE GEAR BOX ADAPTER AND MOTOR.** Remove locking wire from the four nuts which hold the adapter to gear mechanism. Loosen the four nuts as much as possible and raise adapter and traverse motor assembly to unscrew the nuts from the studs. Lift gear box adapter and motor off gear mechanism.

(4) **REMOVE GEAR BOX.** Remove two cap screws and lock washers at lower end of gear case. Support manual traverse drive handle extension and remove upper cap screws. Lift off the gear mechanism and manual drive, being careful not to lose the case key and the case shim.

b. Installation (figs. 176 and 177).

(1) **GENERAL.** If working on a vehicle with a 105-mm howitzer, follow the procedure in step (2) below; on all other models, follow the complete installation procedure (steps (2) through (5) below). Insert the two long cap screws with lock washers through upper supports of gear case. Place spacer over end of each cap screw and lift assembly into position. Start two upper screws with fingers. If working on a 105-mm howitzer, install the two short cap screws with lock washers through the lower case support, then tighten all four cap screws.

(2) **INSTALL CASE KEY AND SHIM.** Insert the case key in slot and slip the case shim into position. Insert two short cap screws with lock washers through lower case support and shim and be sure the key and shim are in position. Tighten upper and lower cap screws.

TURRET TRAVERSING MECHANISM

RA PD 313278

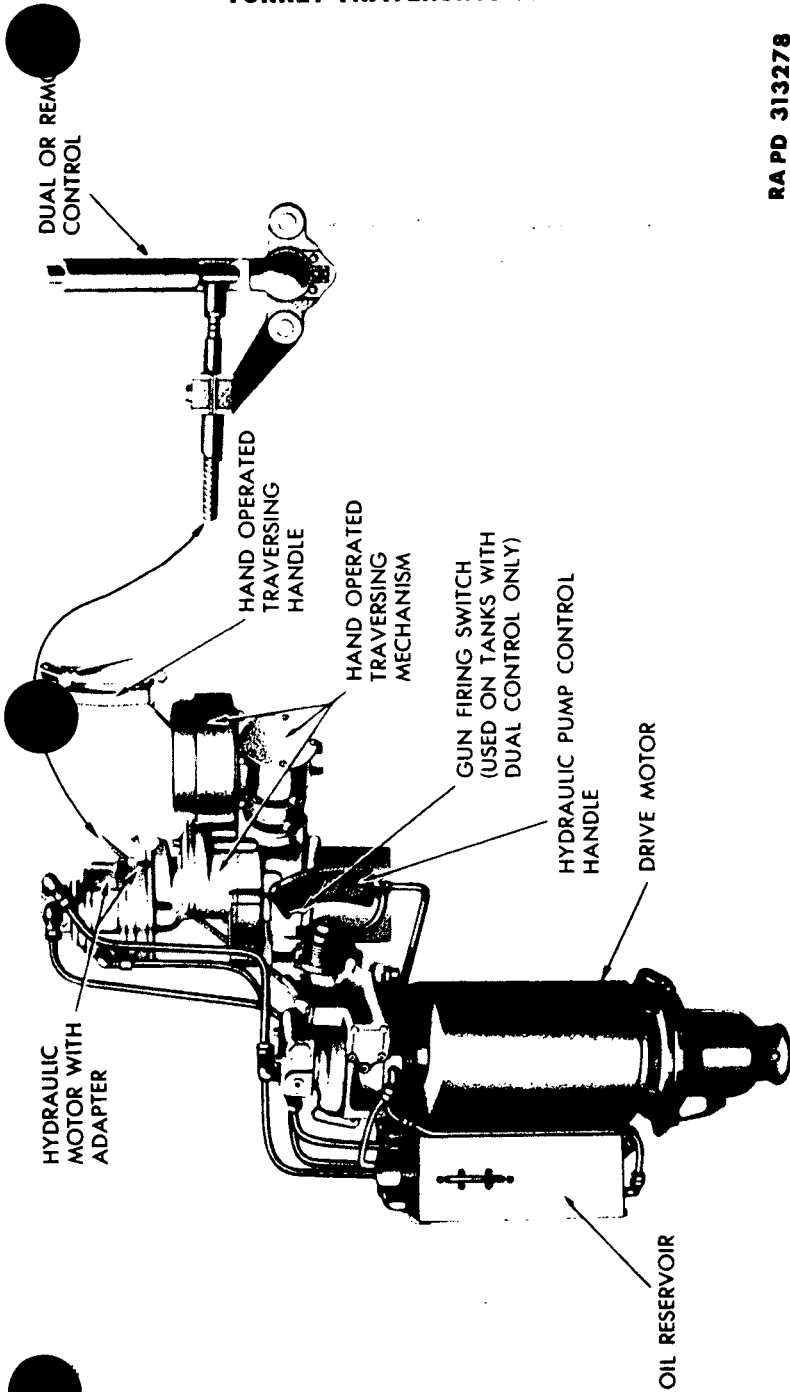

Figure 176—Hydraulic Traversing Mechanism

TANK, MEDIUM, M4A3

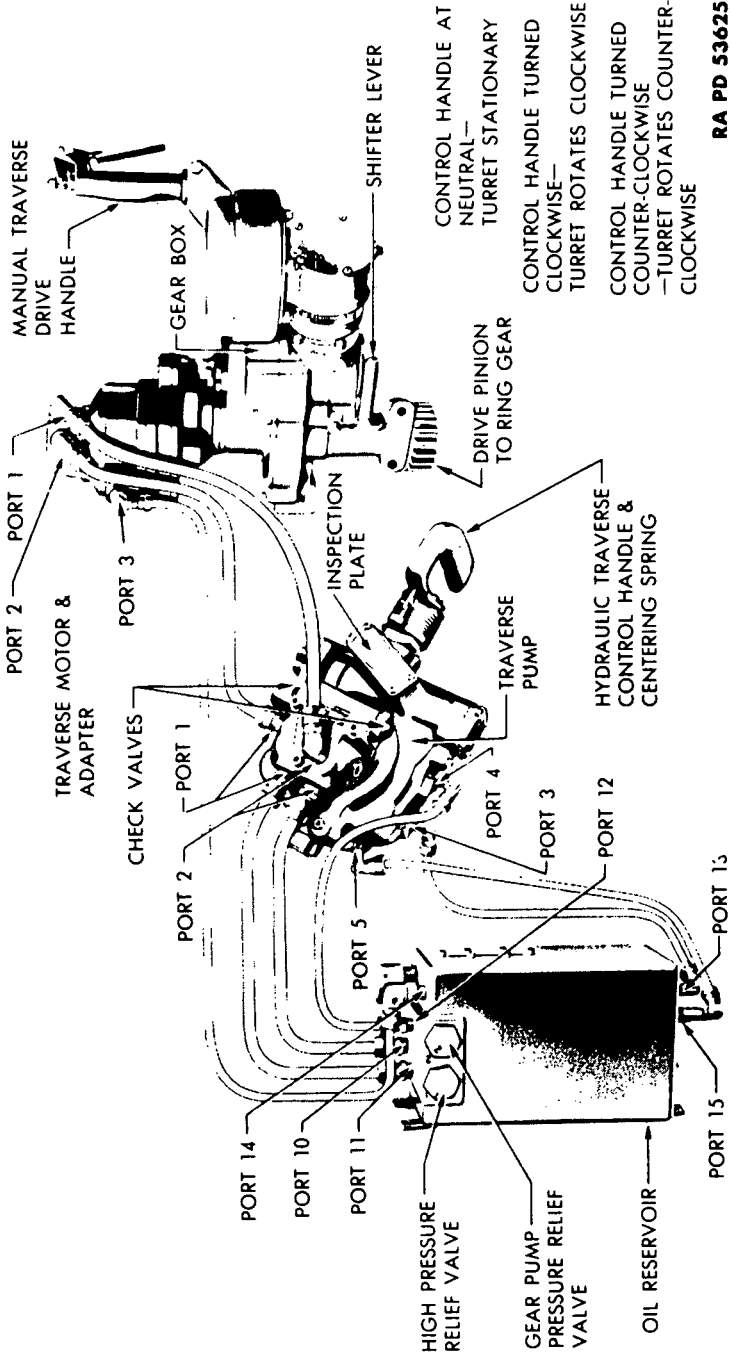

Figure 177—Hydraulic Traversing Mechanism Oil Circuit

TURRET TRAVERSING MECHANISM

(3) **ASSEMBLE ADAPTER AND TRAVERSE MOTOR UNIT TO GEAR MECHANISM.** Set gasket on gear mechanism boss. Position splined end of adapter shaft into gear mechanism pinion and set adapter in place on studs. Fasten adapter to gear mechanism with four safety nuts.

(4) **INSTALL TUBES FROM TRAVERSE MOTOR TO TRAVERSE PUMP AND OIL RESERVOIR.** Insert ends of tubes and rings into their respective fitting and just start the nuts. Install tube from motor port No. 2 to pump port No. 1. Install tube from motor port No. 1 to pump port No. 2. Install tube from motor port No. 3 to oil reservoir port No. 14. After tubes are in place in the manner described, tighten all nuts.

(5) **LUBRICATE GEAR BOX ADAPTER, GEAR AND PINION.** Place a few drops of hydraulic oil onto the gears in the adapter through the small oil cup in the adapter cover.

148. TRAVERSE MOTOR AND GEAR BOX ADAPTER (ALL M4A3 VEHICLES EXCEPT THE 105-MM HOWITZER).

a. **Description** (fig. 178). The traverse motor, flanged to an adapter on top of gear box and piped to the traverse pump, transmits controlled hydraulic power into a rotary drive for traversing the turret in either direction. The adapter unit reduces the speed from traverse motor to the gear train in the gear box.

b. Removal.

(1) **REMOVE TUBES FROM TRAVERSE MOTOR TO PUMP AND OIL RESERVOIR** (fig. 177). Disconnect nuts from fittings in ports 1, 2, and 3 of motor, ports 1 and 2 of pump and port 14 of oil reservoir. Absorb oil draining from motor and tubes in a clean cloth to prevent oil from running down on pump and floor.

(2) **REMOVE TRAVERSE MOTOR FROM GEAR BOX ADAPTER.** Cut and remove lock wire from the eight mounting screws on rim of motor case. Four of these screws hold traverse motor to gear box adapter and four hold traverse motor cover to case. Remove only the four screws directly below the four traverse motor end head mounting screws. Lift the traverse motor and drive pinion off gear box adapter and remove gasket. Cover ends of tubes and tube fittings with paper or cloth to prevent foreign matter from entering the turret traversing system. **NOTE:** *Traverse motor and gear box adapter can be removed as a unit as explained in step (3) below.*

(3) **REMOVE GEAR BOX ADAPTER AND MOTOR** (fig. 178). Loosen the four nuts, which hold the adapter to gear box, as much as possible. Raise adapter and motor assembly to unscrew nuts from the studs. Lift gear box adapter and motor off gear box. Remove gasket from gear box boss.

TANK, MEDIUM, M4A3

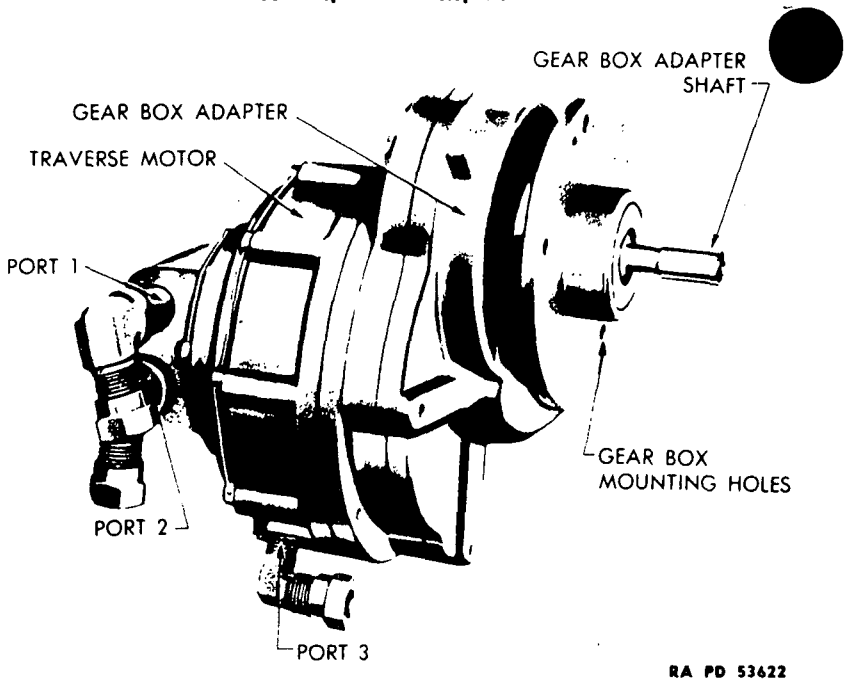

RA PD 53622

Figure 178—Traverse Motor and Gear Box Adapter

c. Installation.

(1) **INSTALL TRAVERSE MOTOR ON GEAR BOX ADAPTER** (fig. 178). Place gasket on gear box adapter. Position traverse motor with drive pinion in gear box adapter. The drive pinion must mesh with the teeth on the intermediate adapter gear. Mount the traverse motor in place with the four mounting screws and lock the eight screws with wire.

(2) **ASSEMBLE ADAPTER AND TRAVERSE MOTOR UNIT TO GEAR BOX** (fig. 177). Place gasket on gear box. Enter the splined end of the adapter shaft into gear box pinion and position the adapter on the studs. Fasten adapter to gear box with four safety nuts.

(3) **INSTALL TUBES FROM TRAVERSE MOTOR TO TRAVERSE PUMP AND OIL RESERVOIR** (fig. 177). Connect the tubes to their respective fitting as identified. Insert ends of tubes and rings into fittings and just start the nuts. Connect the tubes to motor port No. 3 to oil reservoir port No. 14, motor port No. 2 to pump port No. 1, and motor port No. 1 to pump port No. 2. Tighten all nuts.

(4) **FILL TRAVERSE SYSTEM WITH HYDRAULIC OIL.** Check oil level in reservoir. If low, remove breather cap from oil reservoir and add sufficient hydraulic oil.

TURRET TRAVERSING MECHANISM

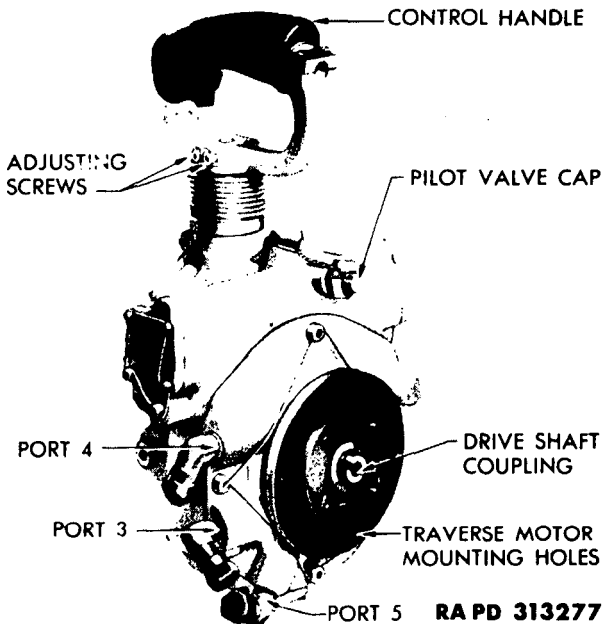

Figure 179—Rear of Traverse Pump

(5) LUBRICATE GEAR BOX ADAPTER GEAR AND PINION. Place a few drops of hydraulic oil onto the gears in the adapter through the small oil cup in the adapter cover.

149. TRAVERSE PUMP (ALL M4A3 VEHICLES EXCEPT 105-MM HOWITZER)

a. **Description** (fig. 179). The traverse pump is coupled directly to, and mounted on top of an electric motor in front of and slightly to the left of the gunner's seat. It supplies hydraulic power to the traverse motor for the turret drive. A control handle mounted integral with the pump enables gunner to accurately select the speed and direction of turret rotation.

b. **Cleaning Pilot Valve Plunger** (fig. 179). Turn off the turret control switch. Remove pilot valve cap, spring and gasket. Push pilot valve plunger up and turn the control handle to force the plunger up and down several times to make certain the plunger is working freely. Reassemble spring, gasket, and cap. Lock cap in place with wire.

c. **Cleaning Check Valves** (fig. 177). Turn off the turret control switch. Remove the check valve cap, spring, and gasket and lift

TANK, MEDIUM, M4A3

out the check valve shim. Inspect seat of check valve for scoring or foreign matter. If seat is scored, replace the pump (subparts e and f below). Clean parts thoroughly and assemble. Lock cap in place with wire. Remove, inspect, and assemble the other check valve in the same manner.

d. **Adjusting Pump Control Shaft for Neutral** (fig. 179). If the turret has a tendency to creep, remove the lock wire on the two screws in the pump control handle and loosen the locking clamp screw. If turret creeps clockwise, loosen upper screw about one-quarter turn and tighten lower screw by same amount. Adjust screws until neutral position is reached. If turret creeps counterclockwise, loosen lower screw and tighten upper screw the same number of turns. Tighten the clamp screw securely after adjustment is completed. Lock screws in place with wire.

e. **Removal.**

(1) **DRAIN THE OIL** (fig. 177). Turn off both battery switches and lower the gun barrel as far as possible. Unscrew flange nut on port No. 13 and drain the oil in a clean container.

(2) **DISCONNECT TUBES (TRAVERSE PUMP TO MOTOR)** (fig. 177). Unscrew the flange nuts on motor port tubes 1, 2, and 3 and pump ports 1 and 2. Unscrew flange nut on reservoir port No. 14. Remove and tag each end of the tubes with identifying port number.

(3) **DISCONNECT TUBES (PUMP TO RESERVOIR)** (fig. 177). Unscrew flange nuts on pump ports 1, 2, 3, 4, and 5 and reservoir ports 10, 11, 12, and 15. Remove and identify both ends of tubes.

(4) **REMOVE PUMP.** Remove the four mounting bolts and lift the pump off the electric motor.

f. **Installation.**

(1) **INSTALL TRAVERSE PUMP.** Place the drive coupling on the electric motor shaft, align the slot with the pump shaft, and position the pump on the electric motor. Install the four mounting bolts, toothed lock washers, and nuts.

(2) **INSTALL TUBES** (fig. 177). Install all tubes, as indicated, which connect the pump, traverse motor and reservoir. **CAUTION:** *Do not tighten flange nuts too tight to avoid damage to the fittings.* If tubes or fittings are damaged, make new tubes and use new fittings.

(3) **FILL SYSTEM.** Fill the reservoir through the filler hole with clean oil of proper specifications (fig. 26).

150. OIL RESERVOIR (ALL M4A3 VEHICLES EXCEPT 105-MM HOWITZER).

a. **Description** (fig. 176). A rectangular oil reservoir, mounted to the left of the traverse pump and drive motor, is connected

TURRET TRAVERSING MECHANISM

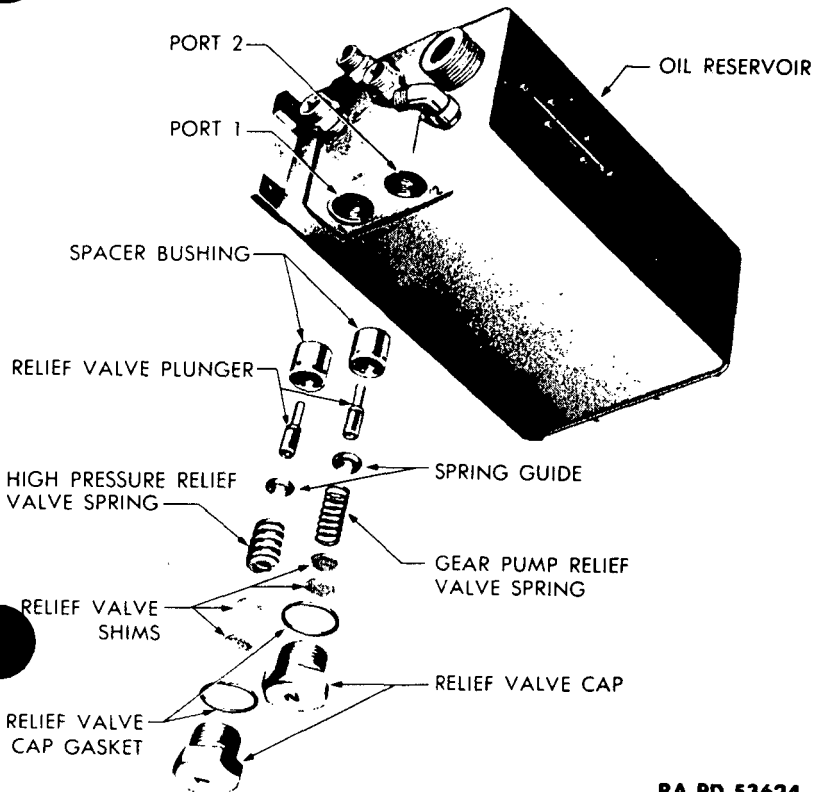

RA PD 53624

Figure 180—Oil Reservoir Relief Valves Disassembled

tubing to the traverse pump and traverse motor. The oil capacity is approximately one gallon. The oil should be maintained at the two-thirds level (fig. 26). Both the high pressure and gear pump pressure relief valves are built into the oil reservoir.

b. **Cleaning High-pressure Relief Valve** (fig. 180). Place a clean shallow pan beneath the oil reservoir. Remove the high-pressure relief valve cap marked No. 1, spring, retainer, plunger and spring guide. Inspect the plunger for scored surfaces, foreign material or signs of wear. Examine inside of relief valve and plunger for any foreign sediment or chips. Start pump, and turn the control handle fully in either direction to force oil out of relief valve hole and push out any foreign matter. Clean and assemble the plunger reservoir bushing. Insert the spring guide into retainer with

TANK, MEDIUM, M4A3

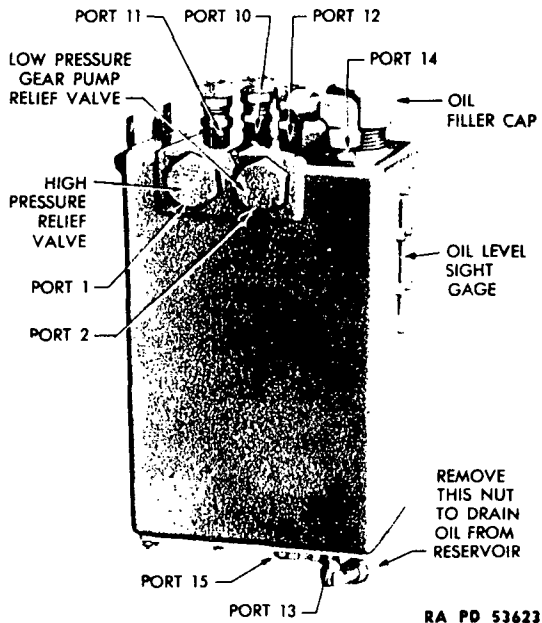

Figure 181—Oil Reservoir

button-head to protrude through hole in the end of retainer. Place the spring over tongue of spring guide, insert the shim (if any) into hole in the relief valve cap and slip cap over the spring and retainer. Tighten the cap and gasket firmly into place.

c. Removal.

(1) **DRAIN OIL** (fig. 181). Disconnect the tube from reservoir port No. 13 and drain the oil into a clean container.

(2) **DISCONNECT TUBES** (fig. 177). Unscrew the tube flange nuts from the pump ports 1, 2, 3, 4, and 5, reservoir ports 10, 11, 12, 14, and 15, and motor port No. 3. Remove the tubes and tag each end with proper port numbers.

(3) **REMOVE RESERVOIR**. Remove the screws which hold the reservoir to the mounting bracket and remove the reservoir.

d. Installation.

(1) **INSTALL RESERVOIR**. Position the reservoir on the mounting bracket and secure with three screws and toothed lock washers.

(2) **CONNECT TUBES** (fig. 177). Install all tubes as identified when removed. Do not tighten the flange nuts too tight to avoid damage to the fittings.

RADIO INTERFERENCE SUPPRESSION

(3) **INSTALL OIL.** Fill the reservoir with clean oil of the proper specifications (fig. 26).

151. DRIVE MOTOR (ALL M4A3 VEHICLES EXCEPT 105-MM HOWITZER).

a. **Description** (fig. 176). A direct current, 24-volt, 2.5 horsepower, 100-ampere, 2,000 revolutions per minute motor is used to drive the traverse pump. This motor also drives the stabilizer oil pump which is mounted on the end, opposite the traverse pump.

b. **Removal.** Disconnect the four copper tubes at the stabilizer pump. Remove the junction box cover plate and disconnect the three leads, identifying each for installation. Unscrew the coupling and remove the cable terminal at the turret master control switch box. Remove the traverse pump mounting screws and the four bolts that hold the drive motor to the basket. Lower the motor to clear the traverse pump drive shaft coupling and remove it from turret platform.

c. **Installation.** Position the electric motor so that engagement is made properly at the traverse pump drive shaft coupling and secure motor to the turret platform with the four bolts. Replace, tighten and lock wire traverse pump to motor mounting screws. Connect and tighten the four copper tubes to the stabilizer pump. Connect the three leads inside the junction box and replace and secure the cover plate. Connect and tighten the cable terminal at the turret master switch box.

Section XXVII**RADIO INTERFERENCE SUPPRESSION****152. INTRODUCTION.**

a. **Purpose.** Radio interference suppression is the elimination or minimizing of the electrical disturbance which interferes with radio reception or would disclose the location of the tank to sensitive electrical detectors. The radio set used in the M4A3 Medium Tanks are designed to meet the requirements of communication under the existing conditions. The placement of tubes, transformers, coils and condensers in the various circuits of the frequency modulated equipment automatically suppress many of the common interferences and produce a high ratio "signal to noise" reception. However, because of the type of operation of these vehicles, many sources of interference are present and must be considered to maintain effective

TANK, MEDIUM, M4A3

tive suppression. It is important that all tanks, with or without radio equipment, be suppressed properly to prevent interference with radio-equipped vehicles.

b. Description. Suppression is accomplished in the M4A3 Medium Tanks by the use of condensers, filters, shielding and/or bonding in all circuits to confine and dissipate electrical disturbances that could affect radio reception. When any electrical circuit is interrupted, such as to stop or change the flow of current, frequencies which interfere with sensitive signal and detective apparatus are broadcast. The extent of this interference depends upon the amount of current flowing and the rapidity of change. The frequencies which are set up will radiate from or feed back into the circuit, causing radio interference. Various types of suppression are used as described below to prevent such interference.

(1) **FILTERS.** Filters are generally constructed of a magnetic coil with two condensers connected in parallel. These units are sealed in a metal shielding and connected in series with the circuit. This type of suppression is used in circuits where rapid interruption or changes of current occur, such as in the ignition or regulator circuits, to prevent a feedback into the battery and to other circuits which are connected to the battery.

(2) **CONDENSERS.** A condenser or capacitor, as sometimes called, is a storage space for electrical energy and functions similar to a surge tank or diaphragm in a hydraulic circuit. The unit is constructed of two layers of a highly conductive flexible material such as tinfoil, insulated from each other by a nonconductive material, usually a wax-impregnated paper. These components are rolled together so that a terminal can be attached to each end of the roll forming contact with the individual layers of foil. The unit is sealed in a metal container with one terminal connected to the container and the other connected to an insulated lead for connection to the circuit. This type of suppression is used in parallel with the circuits which carry a high flow of current, such as in the generator armature, auxiliary generator starter winding, traverse motor and battery leads to the radio.

(3) **SHIELDING.** Shielding, such as conduits, fittings, enclosed terminal boxes and covers, is used to protect the wiring and to afford a conductive path for the radiated frequency to ground (vehicle structure). This type of suppression is used throughout these tanks on all wiring and cables. In some instances, individual wires are covered with a metallic braid which is grounded to form a shield (fig. 182).

(4) **BONDING.** Bonding is a secure ground (conductive contact) to the vehicle structure. Wires, cables, copper braid and plated cl

RADIO INTERFERENCE SUPPRESSION

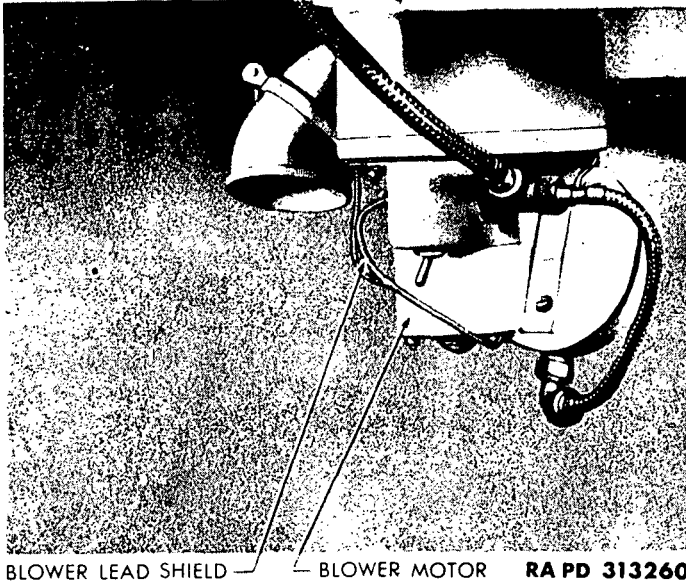

Figure 182—Method of Shielding Individual Wires

or clamps are used for bonding purposes. These bond straps and clips or clamps are attached to a clean surface on the vehicle with plated screws and toothed lock washers. Where the greatest sources of interference is anticipated, the terminals of the bond straps or the flange of the clips are placed between two toothed lock washers and secured to the vehicle. All switch and terminal boxes are mounted with toothed washers against the mounting surfaces as well as under the screw or bolt head and the covers are securely bonded to the boxes. All sand shields and fenders are securely bonded by the use of toothed lock washers in assembly. **IMPORTANT:** *All bonds must be securely restored when replacing any equipment treated for radio suppression.* The ground straps on the engine, auxiliary generator, regulators and instrument panel are necessary to complete the electrical circuit for proper operation of the units. While these ground straps may be sufficiently tight for operation, they may present a source of radio interference if good contact is not insured.

153. IGNITION SYSTEM.

a. **Description.** When the engine is running the magneto points make and break contact rapidly to interrupt the primary circuit. This interruption causes the high-tension circuit to discharge a spark

TANK, MEDIUM, M4A3

at the spark plugs. Both of these conditions set up impulses of frequencies which could be radiated as radio interference. Suppression of the interference is accomplished as follows:

(1) **MAGNETO.** A condenser is used across the contact points in each magneto to prevent arcing and to intensify the high-tension spark. The action of the condenser in performing its function also suppresses the radio interference impulses that would be caused by arcing.

(2) **SPARK PLUGS AND WIRES.** The spark plug wires are enclosed in flexible conduits which form a shield over the wires to dissipate interference.

b. Replacement. The condensers in the magnetos are a part of the ignition circuit and not purposely intended for radio suppression. To eliminate interference from this source, replace the magnetos (par. 66 b). See paragraph 68 b for replacement of spark plugs.

154. STARTING SYSTEM.

a. Description. The cranking motor, cable, solenoid and cranking motor switch are shielded and grounded where necessary to eliminate interference. When the engine is cranked, a heavy flow of current is drawn over the cable and through the contacts of solenoid. Suppression is necessary to minimize the interference set up when the circuit is closed and opened and when the cranking motor is operating.

b. Replacement. A bond strap connects the engine mounting to the hull to insure a good ground for the engine electrical units. Loose connections, burned commutator or faulty brushes would cause radio interference. For information pertaining to replacement of components of the starting system, see paragraphs 105 and 106.

155. BATTERY CHARGING SYSTEM.

a. Description. The generators and regulators are a constant source of radio interference because of the varying friction contact of the generator brushes on the commutator and the rapid action of the contact points in the regulators. Suppression is accomplished as follows:

(1) **GENERATOR.** A condenser, which is mounted inside the commutator end housing of the main generator, is connected to the positive brushes to minimize the interference caused by worn or faulty brushes and commutator. On generators mounted at the rear of the transmission, a ground cable connects the generator to the mounting bracket to insure a good ground for the generator (fig. 118).

RADIO INTERFERENCE SUPPRESSION

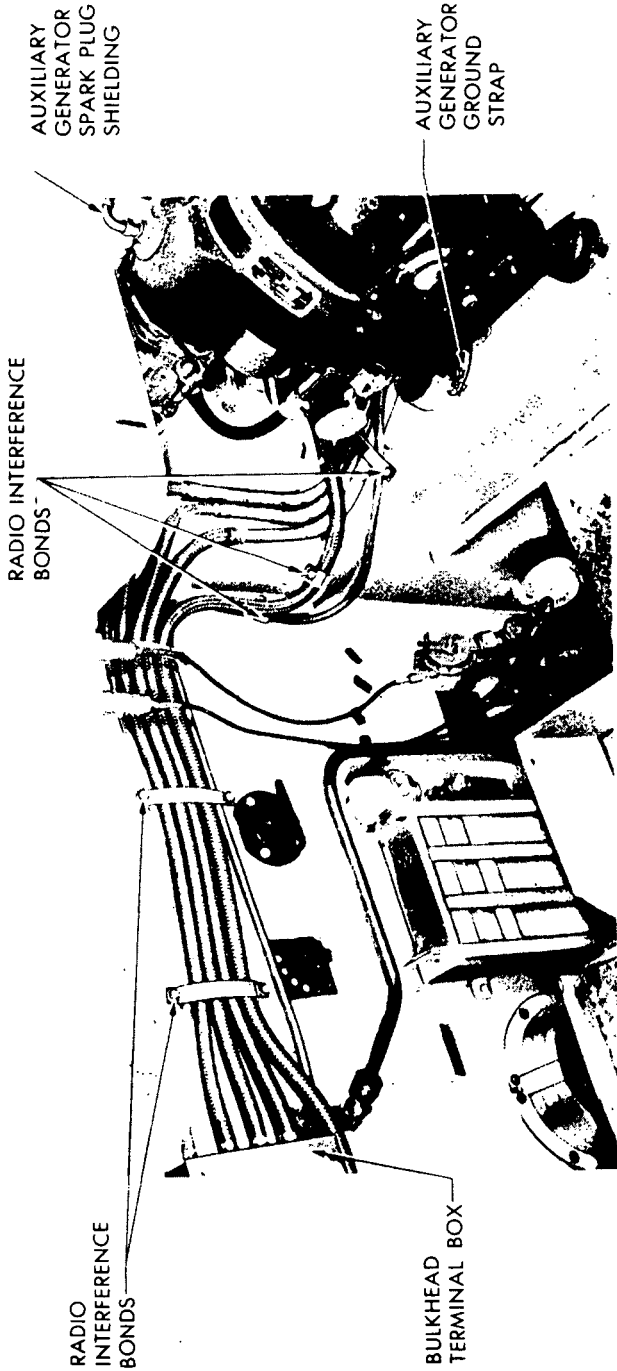

RAPD 313261

Figure 183—Auxiliary Generator and Method of Bonding Conduits

TANK, MEDIUM, M4A3

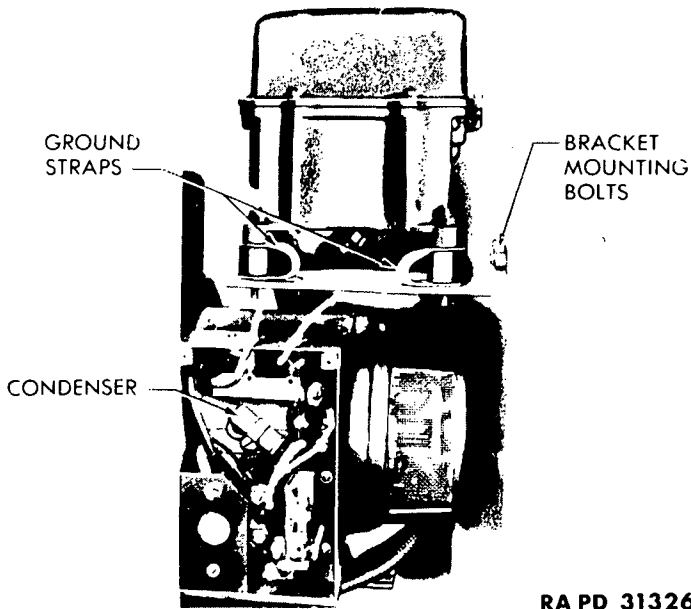

RAPD 313262

Figure 184—Auxiliary Generator Condenser and Regulator Mounting

(2) **REGULATORS.** A filter and a condenser are mounted in each regulator. A ground strap at each shock mount completes the electrical circuits of the regulator as well as insuring a good electrical bond for the elimination of radio interference (fig. 184). The filter is connected in series with the battery lead and the condenser is connected in parallel with the armature circuit.

(3) **AUXILIARY GENERATOR** (figs. 183 and 184). A condenser (ESM 23470) is mounted in the auxiliary generator control box and is connected to the starting circuit winding. A ground strap from the generator frame completes the electrical circuit to the sponson.

b. Replacement.

(1) **GENERATOR AND REGULATOR SUPPRESSION.** The suppression equipment used in the main generator and in the regulators is an integral part of the units. See paragraphs 102 c and 104 b for replacement of these units.

(2) **AUXILIARY GENERATOR CONDENSER** (fig. 184). Remove the cover screws from the auxiliary generator control box and swing the cover up out of the way. Disconnect the condenser and install a new unit of the same type. Install the control box cover.

RADIO INTERFERENCE SUPPRESSION**INSTRUMENTS.**

a. **Description.** All instruments which are enclosed in the instrument box are bonded to and shielded by the box which in turn is bonded to the sponson by a wire. The utility outlet which is sometimes used to connect the windshield wiper for the driver's door hood is suppressed by a condenser connected in parallel with the outlet inside the instrument panel.

b. **Replacement.** Open the 24-volt battery switch and remove the instrument panel cover mounting screws without disconnecting any of the cables or conduits from the back of the box. Pull the top of the panel out for access to the wiring on the back of the panel. Disconnect the condenser lead from the utility outlet and remove the condenser mounting screw. To connect, attach the new condenser with the mounting screw and an external tooth lock washer. Connect the condenser lead to the outlet terminal. Place the panel in position and install the panel screws.

157. WIRING SYSTEM.**a. Description.**

(1) **CONDUITS** (figs. 183 and 185). All wiring is contained in protective conduits which act as shielding for the electrical circuits. These conduits are secured in position with clips or brackets fastened to the hull with toothed lock washers and screws.

(2) **RADIO TERMINAL BOXES** (fig. 185). Two condensers are used in radio terminal box in parallel with the number 6 wire (12-volt) and the number 7 wire (—) 24-volt circuits. The boxes are mounted with toothed lock washers between the hull (or turret) and the box as well as under the mounting screw heads.

b. **Replacement.** See paragraph 101 b (1) for removal and installation of conduits. *NOTE: It is very important that all conduits be securely clamped when installed.*

158. TURRET TRAVERSING SYSTEM (ALL M4A3 MEDIUM TANKS EXCEPT 105-MM HOWITZER).

a. **Description.** The electric motor in the turret which drives the oil pump for the hydraulic traverse motor and the stabilizer presents a source of radio interference because of the brush and commutator action. A condenser is used in parallel with the motor lead at the circuit breaker in the turret control box. A bond cable is connected from one of the lugs on the turret collector ring terminal from one of the lugs on the turret collector ring terminal box, to provide a positive ground for the turret and its electrical mechanism. *CAUTION: The turret may operate without this ground strap but radio interference will be encountered and possible*

TANK, MEDIUM, M4A3

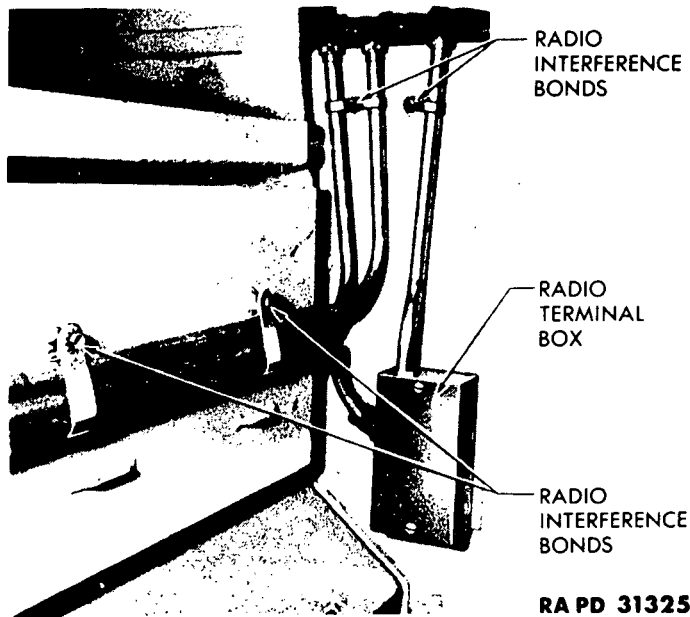

RA PD 313259

Figure 185—Radio Terminal Box and Method of Bonding Circuits

damage to the turret race ball bearings because of poor electrical contact.

b. **Replacement** (fig. 185). To replace the condenser, turn off the 24-volt battery switch and remove the right-hand section of the turret terminal box cover. Disconnect the condenser from the traverse motor circuit breaker and remove the condenser mounting screw. To install, mount the condenser in place with the mounting screw and toothed lock washer. Connect the condenser lead to the traverse motor cable contact on the circuit breaker. Install the terminal box cover.

PART FOUR—AUXILIARY EQUIPMENT**A—AUXILIARY GENERATOR, FIXED FIRE EXTINGUISHER SYSTEM, COMMUNICATION EQUIPMENT****Section XXVIII****AUXILIARY GENERATOR****159. DESCRIPTION.**

a. The auxiliary generator is a self-contained generating unit. It is used to charge the tank batteries at such times as the use of the stabilizer-unit, turret traversing motor, gun firing solenoids, radio and interphone installations and ventilating fans impose too heavy a load on the electrical system. The unit is located in the left rear corner of the fighting compartment on the sponson.

160. REPLACEMENT.**a. Generator.****(1) EARLY VEHICLES (fig. 21).**

(a) *Removal.* Open the battery master switch. Remove the air cleaner. Disconnect the exhaust coupling at the cylinder. Close the shut-off cock on the fuel filter and disconnect the fuel line at the carburetor. Remove the control box cover. Disconnect the three wires that come through the back of the control box from the generator yoke. Tag these wires for later identification. Remove the two screws that hold the control box to the generator yoke and remove the box. Remove the bolts that secure the foot mounting (except the rear one on the generator) to the sponson. On the remaining mounting, disconnect the angle iron support from the sponson. Lift the unit from the vehicle.

(b) *Installation (fig. 21).* Position the auxiliary generator on the sponson. Install the bolts that secure the foot mounting (except the rear one on the generator end) to the sponson. On the remaining mounting, connect angle iron support to the sponson. Install the control box on the generator yoke. Push the three wires through the opening in the rear of the box and connect the wires to their correct terminal post. Install the cover on the control box. Connect the fuel line to the carburetor. Open the shut-off cock on the fuel filter. Place a new gasket between the exhaust coupling and cylinders and install the four bolts. Install the air cleaner.

(2) LATER VEHICLES.

(a) *Removal (fig. 20).* Open the master switch. Cut the wing nut lock wires on the regulator terminal box cover, and remove wing

TANK, MEDIUM, M4A3

nuts and cover. Disconnect the two lead wires that are attached to the terminals marked "A" and "F" in the regulator terminal box. Identify the wires for installation. Unscrew the knurled connector nut on the generator to regulator conduit at the terminal box and pull out the wires. Remove the clamps that hold the conduit to the sponson. Unlatch and lift off the battery box cover and remove battery box baffle plate. Disconnect the generator to battery box conduit at the side of the battery box. Disconnect the yellow wire at the battery box terminal, remove from the box and identify for installation. Remove the auxiliary generator heater duct inspection plate. Disconnect the flexible exhaust coupling at the cylinder. Close the shut-off cock on the fuel filter and disconnect the fuel line at the carburetor. Disconnect the generator ground strap at the sponson. Remove the bolts that hold the generator angle iron supports to the foot mountings, and lift out the assembly.

(b) *Installation* (fig. 20). Open the master switch. Position the generator on the sponson with the angle iron supports on the foot mountings and the control panel to the front, and install the mounting bolts. Place a gasket between the flexible exhaust flange and the engine cylinder flange, and install the attaching screws. Install the heating duct inspection plate. Place a toothed lock washer on each side of the ground strap terminal, and attach to sponson with attaching screw. Insert the wire from the generator to battery box conduit through the opening in the battery box, and attach it to the top post on the shunt terminal with a nut and split-type washer. Connect the conduit to the battery box with the knurled conduit nut. Insert the black wire and the yellow wire from the generator to regulator conduit through the forward opening in the side of the regulator terminal box. Attach the black wire to the connector strap marked "A" with a cap screw and split-type washer. Connect the yellow wire on the regulator terminal marked "F" with an external-toothed lock washer between the wire terminal and the regulator terminal, and secure with a cap screw and split-type washer. Attach the generator to regulator conduit to the regulator terminal box with the knurled conduit nut. Position the regulator terminal box cover on the terminal box, secure with wing nuts, and install lock wire. Close the master switch, start the auxiliary generator and test.

b. Muffler and Tail Pipe.**(1) EARLY VEHICLES.**

(a) *Removal.* Open the engine compartment doors. Remove the engine front plate. Remove the two nuts and lock washers that secure the tail pipe to the muffler. Loosen the clamp at the lower end of the muffler. Remove the two cap screws and lock washers that secure the muffler bracket to the bulkhead and remove

FIXED FIRE EXTINGUISHER SYSTEM

ffier. Remove the cap screws that secure the tail pipe hold-down clamps to the hull, and remove the tail pipe.

(b) *Installation.* Install the muffler on the exhaust pipe, but do not tighten the muffler clamp. Secure the muffler and bracket to the bulkhead with two cap screws and lock washers. Tighten the clamp on the lower end of the muffler. Place a new gasket between the tail pipe and muffler, and secure the tail pipe to the muffler with two cap screws and lock washers. Secure the tail pipe and clamps to the hull with cap screws.

(2) **LATER VEHICLES.**

(a) *Removal.* Remove the auxiliary generator (subpar. a (2) (a) above). Remove the terminal box that is mounted on the shroud. Remove the conduit clamps and move the conduit to one side to permit removal of the shroud. Remove the shroud. Loosen the clamp at the lower end of the muffler and lift the muffler off the tail pipe.

(b) *Installation.* Slide the muffler onto the tail pipe and position the muffler so the exhaust coupling on the muffler will be in line with the exhaust coupling on the auxiliary generator. Tighten the clamp on the lower end of the muffler. Install the shroud. Secure the terminal box in place on the shroud. Secure the conduit clamps to the hull. Install the auxiliary generator (subpar. a (2) (b) above).

Section XXIX

FIXED FIRE EXTINGUISHER SYSTEM**161. FIXED FIRE EXTINGUISHER SYSTEM.**

a. **Removal of Fire Extinguisher Cylinders.** Unscrew the control head swivel nut from the cylinder and lay the head aside. Loosen the discharge tubes at the check valve and disconnect the tubes from the cylinders. Remove the cylinder clamp bolts and lift out the cylinder.

b. **Installation of Fire Extinguisher Cylinders.** Place the cylinder in position and install the clamp bolts. Connect the discharge tubes to the cylinder and tighten the tubes to the check valve. Install the control head on the cylinder.

c. **Removal of Conduit and Cable (Dual-pull-to-control-head).**

(1) **REMOVE CONDUIT** (figs. 186 and 187). Unscrew the large swivel nut, and remove the control head from the cylinder. Disconnect the conduit at both ends, and remove the clamp from the bulk-

TANK, MEDIUM, M4A3

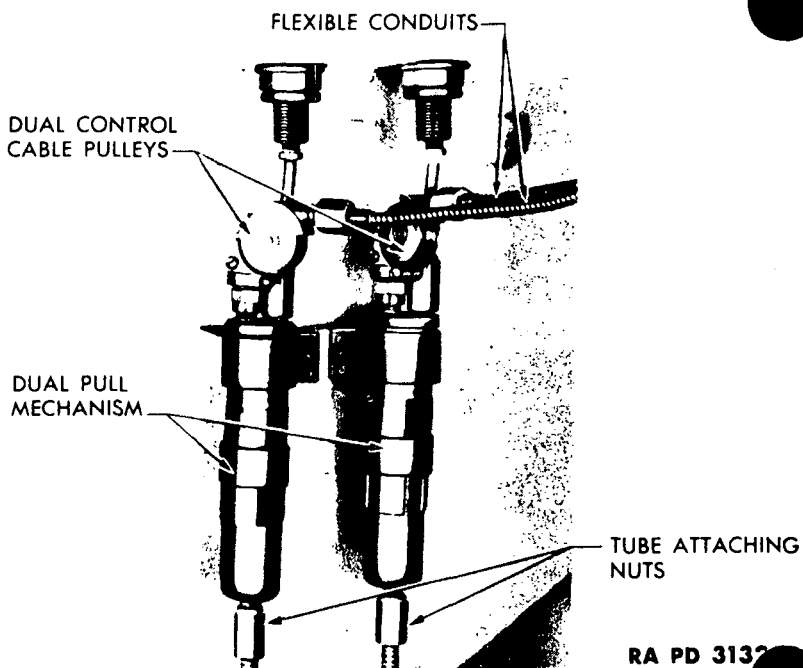

RA PD 3132

Figure 186—Dual Pull Mechanism

head. Screw off the lower half of the dual pull mechanism, and disconnect the cables. Slide the conduit off the upper end of the cable.

(2) **REMOVE CABLE.** Remove the lock wire and three screws which attach the cover plate to the control head, and remove the cover. Disconnect the cable, and pull it out of the control head.

d. Installation of Conduit and Cable (Dual-pull-to-control-head).

(1) **CONNECT CABLES.** Insert the ends of the two pull cables and the end of the control cable into a 2-inch piece of copper tubing. Pull the upper cables tight, and slide the copper tube up to the upper half of the dual pull mechanism. Crimp each end of the copper tube around the cables, then hold the upper end of the tube and twist the lower end two complete turns to securely connect the cables.

(2) **INSTALL CONDUIT.** Slide the lower half of the dual pull barrel and the conduit over the cable. Screw the barrel into place and connect both ends of the conduit. Install the conduit clamp to the bulkhead.

FIXED FIRE EXTINGUISHER SYSTEM

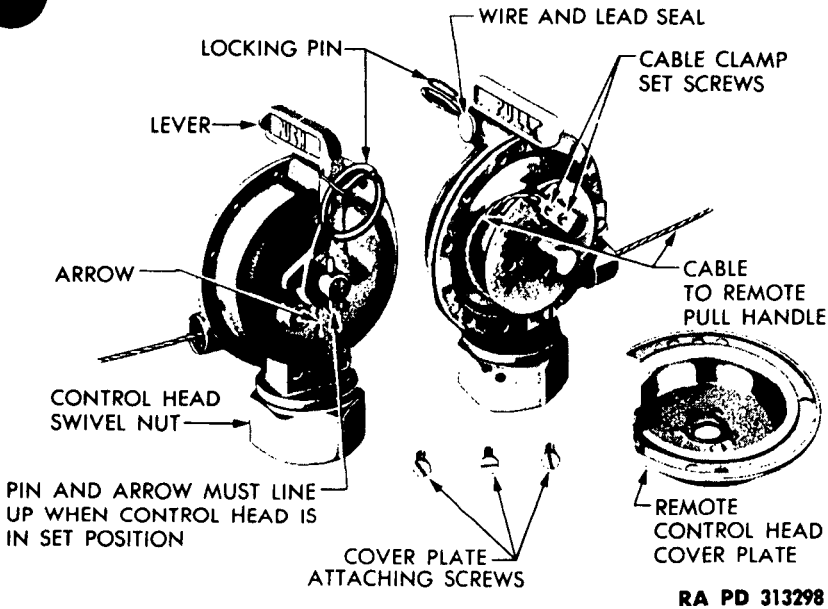

Figure 187—Control Head Assembly

(3) **CONNECT CABLE TO CONTROL HEAD** (fig. 187). Place a 1/2-inch pin between the pull cable and the pulley on top of the dual pull barrel to provide the proper slack in the cables. Turn the pulley in the control head clockwise until the pin contacts the stop and is in line with the arrow on the control body. With the pulley in that position, pull the cable tight over the 1/2-inch pin and connect it to the pulley in the control head, then remove the pin. Install the control head cover, then install the head on the cylinder.

e. Removal of Pull Cable (to control box on top of hull). Unscrew the large nut and remove the control head from both fire extinguisher cylinders. Remove the lock wire and three screws which attach the cover plate to the control head and disconnect the cable from the head. Disconnect the conduit from the bottom of the dual pull barrel. Unscrew the lower half of the barrel and disconnect the cables. Pull the handle and cable out of the control box.

f. Installation of Pull Cable (to control box on top of hull).

(1) **INSTALL CABLE.** Remove the plate and pulleys from the control box. Attach cable to the pull handle and thread the cable over the pulley and down through the tube to the dual pull barrel. Pull both cables tight while installing the plate in the control box.

TANK, MEDIUM, M4A3

(2) **CONNECT CABLES** (subpar. d (1) above).

(3) **CONNECT LOWER HALF OF DUAL PULL BARREL AND CONDUIT**. Screw the lower half of the dual pull barrel into place, and connect the conduit to the barrel.

(4) **CONNECT CABLE TO CONTROL HEAD** (subpar. d (3) above).

g. Removal of Pull Cable or Conduit (to bracket over driver's seat). Unscrew the large nut and remove the control head from the fire extinguisher cylinder. Remove the lock wire and three screws which attach the cover plate to the control head, and disconnect the cable from the head. Disconnect the conduit from the bottom of the dual pull barrel. Unscrew the lower half of the barrel, and disconnect the cables. Pull the handle and cable out of the bracket above the driver's seat. Disconnect the conduit at both ends. Remove the conduit clamps from the hull, and remove the conduit.

h. Installation of Pull Cable or Conduit (to bracket over driver's seat).

(1) **INSTALL CABLE AND CONDUIT.** Attach the cable to the pull handle, and insert the cable through the bracket above the driver's seat. Thread the cable through the conduit and pulley and down through the dual pull barrel. Connect both ends of the conduit, and install the clamps to the hull.

(2) **CONNECT CABLES IN DUAL PULL BARREL** (subpar. d (2) above).

(3) **CONNECT LOWER HALF OF DUAL PULL BARREL AND CONDUIT** (subpar. f (3) above).

(4) **CONNECT CABLE TO CONTROL HEAD** (subpar. d (3) above).

Section XXX**COMMUNICATION EQUIPMENT****162. DESCRIPTION.**

a. General (figs. 188 and 189). M4A3 Medium Tanks are equipped with radio and interphone systems, shock-mounted on a common base located on a shelf in the turret bulge. Interphone control boxes are provided for each member of the crew. The power supply for the system is supplied from the batteries of the vehicle. The operating voltage of the sets is indicated on a plate attached to the right front of the mounting base. One of the following frequency modulated radio telephone sets, models SCR 508, SCR 528,

COMMUNICATION EQUIPMENT

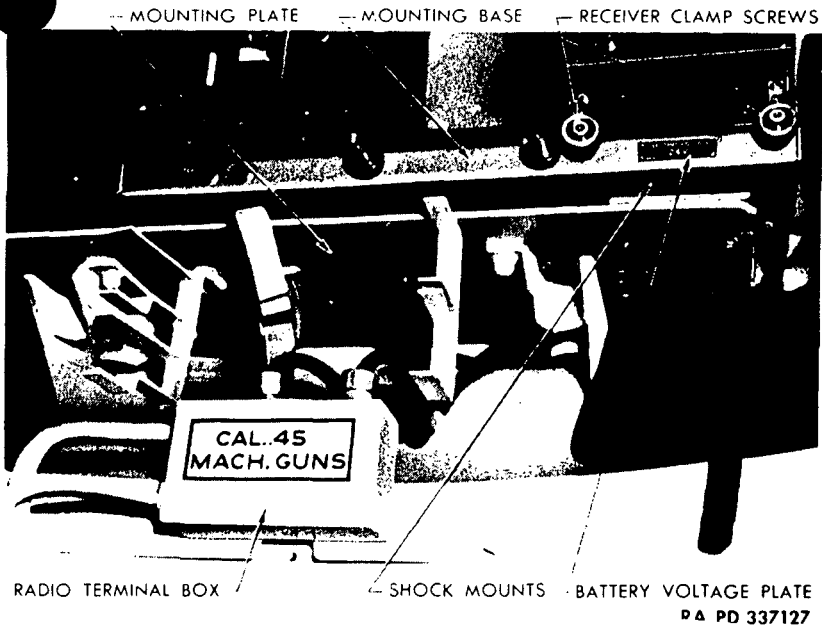

Figure 188—Radio Mounting Base

or SCR 538, may be used in the tank, depending on the type of operation to which the vehicle is assigned. Detailed descriptions and instructions covering these sets are contained in TM 11-600.

(1) **MODEL SCR 508.** This radio set, which consists of a radio transmitter, model BC 604, and two radio receivers model BC 603, mounted on a base, model FT 237, is generally used in command vehicles.

(2) **MODEL SCR 528.** This set consists of a radio transmitter, model BC 604, and one radio receiver, model BC 603, mounted on the base, model FT 237.

(3) **MODEL SCR 538.** This set consists of an interphone amplifier, model BC 605, and one radio receiver, model BC 603, mounted on the base, model FT 237. This set is used where a transmitter is not required.

b. Mounting Base Model FT 237 (fig. 188). This mounting base, which is used with each of the radio sets described in steps (1), (2), and (3) above, is wired through a multiple connector receptacle into which the units of the set can be plugged. Two bed plates are attached to the mounting base with four rubber shock mounts (two on each plate) to support the radio set. Two additional

TANK, MEDIUM, M4A3

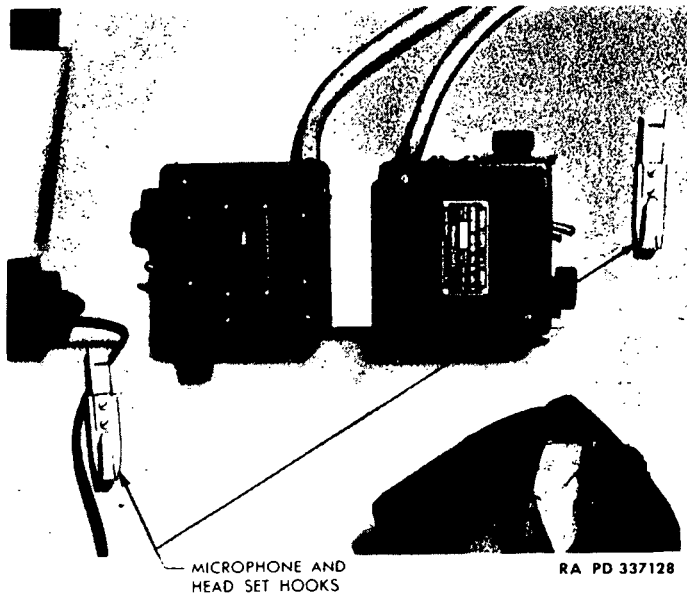

Figure 189—Turret Interphone Control Boxes

rubber shock absorbers, on each bed plate, prevent excessive movement of the set. The bed plates are secured to the radio shelf in the turret with four cap screws through each plate. The units of the set are fastened to the mounting base with screws and clamps as follows:

(1) **MODEL SCR 508.** The transmitter is plugged into its allotted position at the left end of the mounting base and the two receivers are installed in the remaining position.

(2) **MODEL SCR 528.** The transmitter is mounted at the left end and the one receiver at the extreme right position, leaving the center position open for access to transmitter adjustments.

(3) **MODEL SCR 538.** The left end of the mounting is vacant. The receiver is plugged into the center position and the interphone amplifier is located in the extreme right position. **CAUTION:** *Do not mount an amplifier and a transmitter on the same base.*

c. Antennas.

(1) **MAST BASE.** A mast base, model-MP 37, equipped with a large helical spring of flexibility, is rigidly mounted to the top of the turret.

COMMUNICATION EQUIPMENT

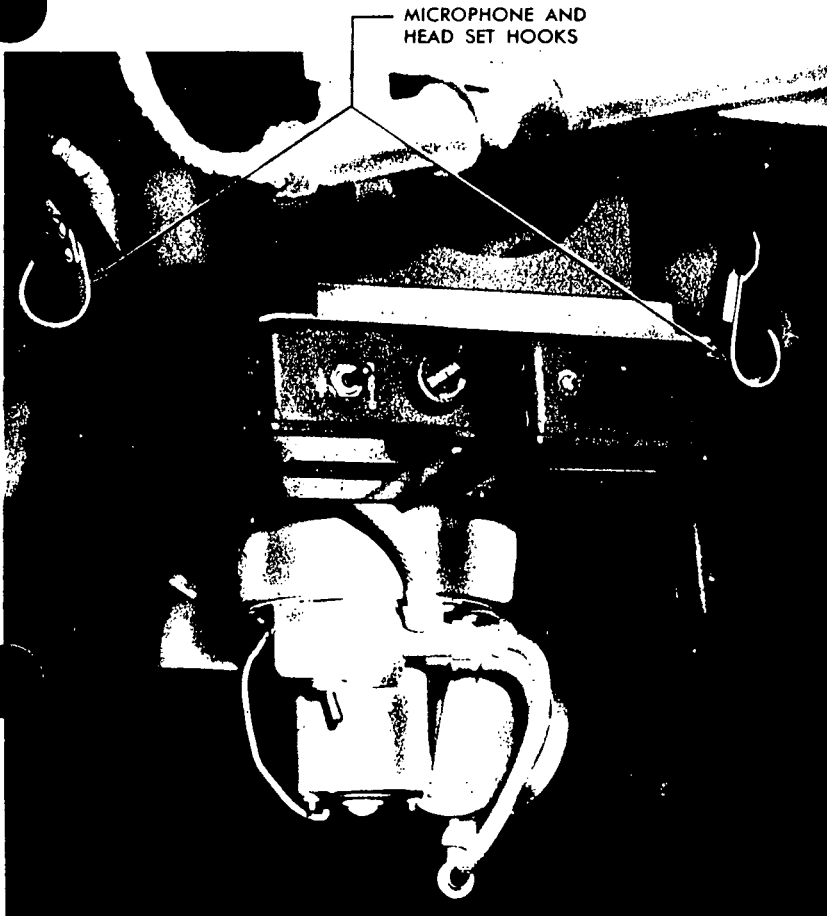

RA PD 337129

Figure 190—Driver's and Assistant Driver's Compartment Interphone Control Boxes

(2) **MAST SECTIONS.** Three mast sections, models MS 51, MS 52, and MS 53 used with the radio sets described in subparagraph a above, are screwed together to form the antenna. The sections are made of high tensile strength steel and the ends which join together have enamel marks of the same color. The body of the mast bears the type number. The mast sections are stored in Roll BG 56 when not in use.

d. **Interphone Control Boxes** (figs. 189 and 190). The interphone control boxes contain controls and connection facilities for the

TANK, MEDIUM, M4A3

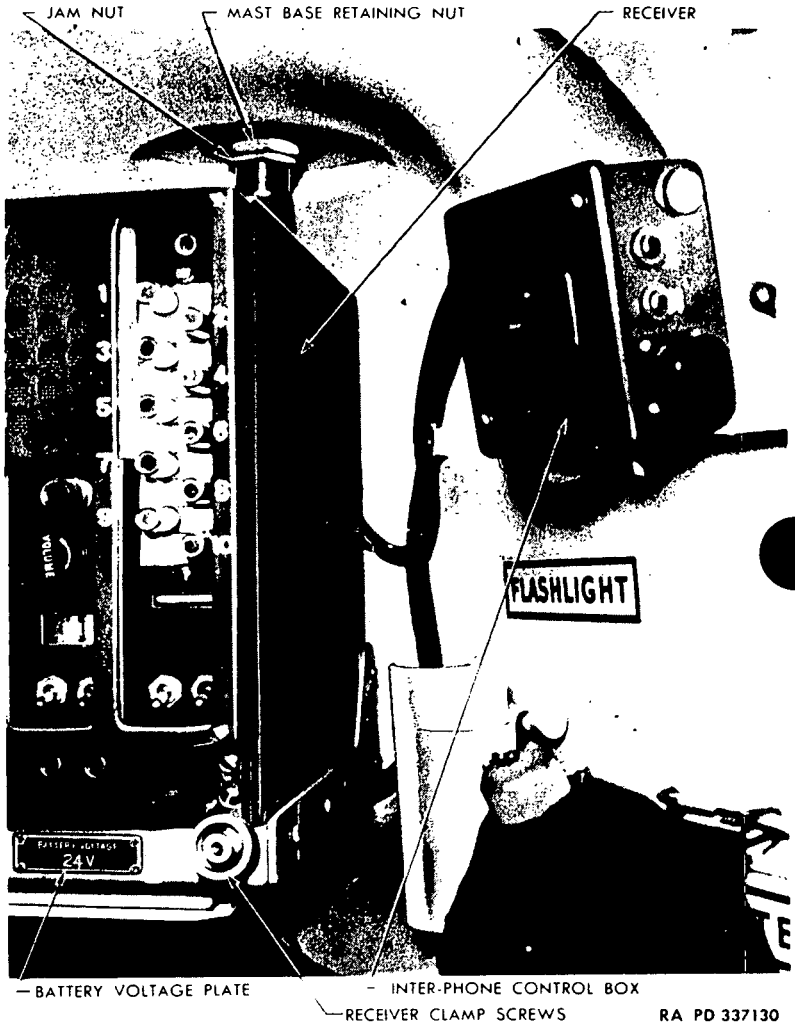

Figure 191—Method of Mounting Mast

COMMUNICATION EQUIPMENT

microphones (carbon or magnetic) and the headsets used by members of the tank crew at their respective stations. The plug jacks are identified for connection of the type of microphone supplied and the volume control knob regulates the speech volume in the headset. Hooks are mounted adjacent to each control box for convenient placement of the microphone and headset when not in use.

163. INSPECTIONS.

a. Antenna.

(1) **MAST SECTIONS.** Inspect the antenna mast sections to be sure that they are securely screwed and clamped together and are not damaged.

(2) **HELICAL SPRING.** Inspect the helical spring on the base. Be sure that it maintains a vertical position and is not damaged to prevent flexibility.

(3) **MAST** (fig. 191). See that the mast is secured to the top of the turret.

(4) **LEADS TO SET.** Check the leads to the set and make sure that nothing interferes with them or could damage the cords.

b. Mountings (fig. 188).

(1) **CLAMP SCREWS.** Make sure that the units are securely fastened into the mounting base.

(2) **SHOCK MOUNTS.** Inspect the mounting screws to see that they are tight and that the shock mountings are in good condition. Rock the set to determine if it is bumping against any other equipment and observe whether the shock absorbers prevent excessive movement.

c. **Cords and Connections** (fig. 192). Inspect all cords which connect the radio or interphone control boxes to see that they are not damaged. Make sure they are properly secured in the clips. Report any damage to the proper authority. Make sure that the cords are not twisted or knotted to prevent movement of the wearer. Inspect the jack plugs on the microphone and headsets to see that they are not damaged.

d. **Interphone Control Boxes, Microphones and Headsets.** (figs. 189 and 190). Inspect the control boxes for damage, looseness and operation. Handle the microphones and headsets with care, and see that they are hung on the hooks provided for this purpose when not in use.

TANK, MEDIUM, M4A3

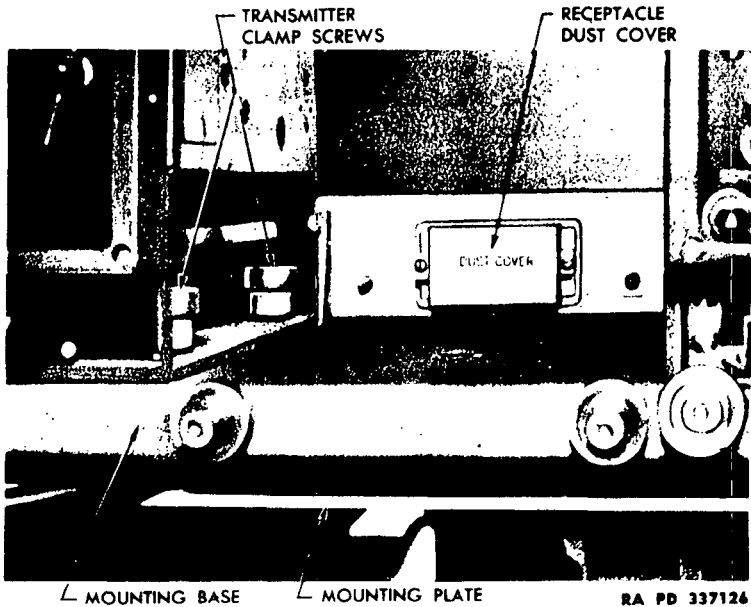

RA PD 337124

Figure 192—Radio Mounting Bolts

e. **Covers.** Check to see that all covers for the protection of the radio set are available in the vehicle and make sure that these covers are installed when the equipment is not in use. See that all fasteners and zippers are in good condition.

164. **PRECAUTIONS.**

a. **Antenna.** Tie the antenna back securely when the tank is in motion and radio is not in use to prevent breakage. Make sure the antenna is vertical and not touching anything when the radio is in use.

b. **Radio.**

(1) Keep the radio covered when the vehicle is not in use to prevent dust and moisture entering the set. Keep all hatch doors securely closed and fastened.

(2) Turn off all radio switches when not in use. Do not turn off the battery switch with the radio on.

(3) Do not store equipment behind the radio where it can prevent motion of the shock mountings or damage the connecti

COMMUNICATION EQUIPMENT

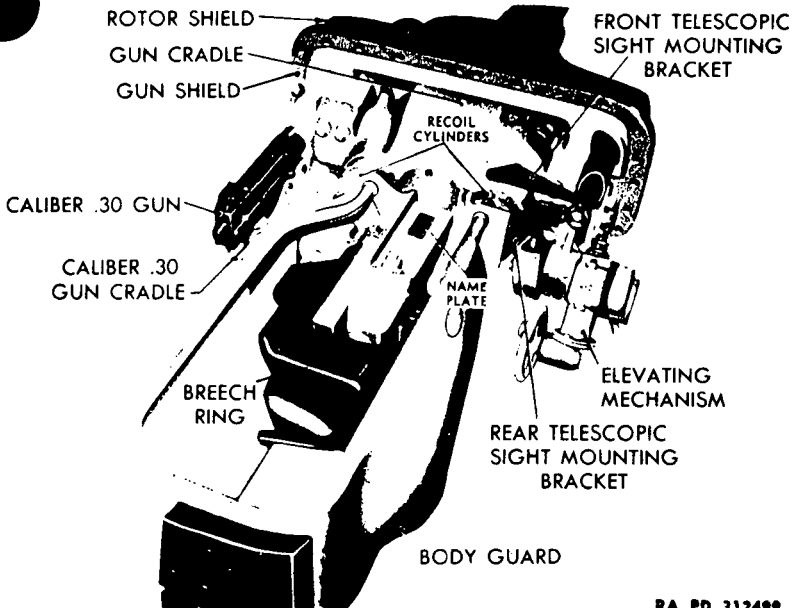

RA PD 312499

Figure 193—Combination Gun Mount M34A1—Rear View

- (4) Do not start the engine with the radio turned on.

c. Batteries and Generating System.

(1) Make sure that the batteries are properly charged at all times to insure satisfactory operation of the set. Low batteries will cause the set to be noisy, resulting in poor reception.

(2) See that all battery cables and terminals are in good condition and tight.

(3) Test the operation of the generator and regulator (par. 43 d (1) and (2)). Excessive charge will damage the radio and make it noisy.

- (4) Do not race the engine while the radio is in operation.

d. Interphone Equipment. This equipment is sensitive and delicate. *Do not drop or misuse it.* Keep the microphone and headset on their hooks, when not in use. Keep cords clear of moving equipment in the vehicle.

TANK, MEDIUM, M4A3

**PART FOUR—AUXILIARY EQUIPMENT (Contd.)
B—ARMAMENT**

**75-MM GUN M3 IN THE COMBINATION GUN
MOUNTS M34 AND M34A1**

Section XXXI

INTRODUCTION

165. SCOPE.

a. Part Four-B contains instructions on the operation of the 75-mm Gun M3 in the Combination Gun Mounts M34 and M34A1. It lists the authorized ammunition and contains information on the sighting equipment. Refer to section IX for lubrication instructions on the armament.

b. The other armament on the Medium Tank M4A3 is as follows: Machine gun, cal. .30, M1919A4, located in the Combination Gun Mount M34 or M34A1; Machine Gun, cal. .30, M1919A4, mounted in the front of the tank on the right side in the flexible bow mount D51070; Machine Gun, cal. .50, HB, M2, when used is mounted in a bracket-type mount on the revolving turret hatch; and a 2-inch Mortar M3, located in a fixed mount in the turret to the left of the combination gun mount.

166. CHARACTERISTICS.

a. The armament is employed chiefly against enemy tanks and other ground objectives. The turret can be traversed 360 degrees manually or by a hydraulic traversing mechanism. The gun can be elevated 25 degrees and depressed 10 degrees. The cal. .30 machine gun in the combination gun mount is elevated and traversed with the 75-mm gun.

b. The cal. .30 machine gun in the bow mount is elevated and traversed manually and fired by the conventional trigger. Refer to FM 23-50 for complete information on its operation.

c. The cal. .50 machine gun is employed chiefly against enemy aircraft. It is elevated and traversed manually and fired by the conventional trigger. The machine gun can be traversed independently of the turret. Refer to FM 23-65 for complete information on its operation.

d. The 2-inch mortar is used to lay a smoke screen while the tank is advancing. It is in a fixed mount, has no elevation or depression, traverses with the turret, and is manually fired. Refer to TM 9-293 for complete information on its operation.

OPERATING INSTRUCTIONS

177. DIFFERENCES AMONG MODELS.

a. **Differences Between M34 and M34A1 Combination Gun Mounts.** The Mount M34 has been modified to M34A1 which incorporates a direct-sight telescope. The 75-mm Gun M3 uses the Direct-sight Telescope M55 or M70F in the Combination Gun Mount M34A1 (fig. 193). The other modifications of the mount consist essentially of the following:

- (1) Addition of a new front shield which protects the cal. .30 coaxial machine gun, the 75-mm gun, and the direct-sight telescope.
- (2) Addition of a breech counterweight to balance the new shield.
- (3) Machining a slot in the front plate to allow the telescope to protrude through the opening.
- (4) Machining a pad on the mount to hold the telescope mounting brackets.
- (5) Machining two additional slots in the front plate to allow for bolts holding the shield.

Section XXXII

OPERATING INSTRUCTIONS

168. PLACING THE 75-MM GUN IN FIRING POSITION.

- a. Remove the breech and muzzle covers.
- b. Remove the pin from the traveling lock, which holds the gun in position while traveling, and lock the traveling lock in position under turret roof.
- c. Disengage the turret clamp by turning the wheel of the turret clamp all the way to the left or counterclockwise.

169. INSPECTION BEFORE FIRING.

- a. **Check Oil Level In Recoil Cylinder.** To check oil level, depress gun nine degrees and remove recoil cylinder filling plug (fig. 194) at the rear end of each recoil cylinder. The oil level in the cylinder should reach the bottom of the hole. If oil does not reach this level, fill until level is reached. Replace plugs. The recoil mechanism uses special recoil oil for all temperatures.
- b. Check path of recoil to make sure that it is free from all obstructions.
- c. Open breech and inspect bore of gun for cleanliness.
- d. **Bore Sighting.** Refer to paragraph 181.

TANK, MEDIUM, M4A3

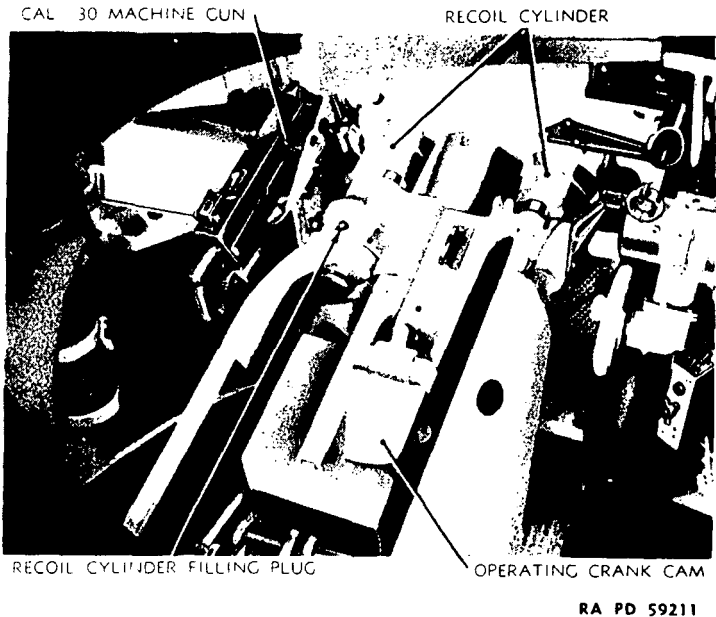

RA PD 59211

Figure 194—Recoil Cylinder Filling Plug

170. TRAVERSING TURRET.

a. **Power Operation** (fig. 195). Before traversing turret by means of the hydraulic traversing mechanism, be sure the doors for the driver and assistant driver are closed. Make sure personnel are clear of rotating parts. Move gearshift lever in front of gunner and under gear mechanism, to the "UP" or "POWER" position. It may be necessary to turn slightly the manual drive handle on top of gear mechanism to engage gears. Turn master switch to the "ON" position to start electric drive motor. Disengage the turret positive locking clamp by turning handwheel to the left or counterclockwise, as far as possible. **CAUTION:** *It is important to have locking clamp completely disengaged before traversing turret and to lock turret in position when need for traversing has been completed.* The control handle on the traverse pump, to the right of the gun elevating handwheel, controls the speed and direction of turret rotation. To traverse turret to the right, turn the control handle so that the top is to the right. To traverse turret to the left, turn the control handle so that the top moves to the left. To increase the traverse speed, turn the control handle farther to the left or right, depending upon the direction of traverse. To stop turret traverse, release control handle, or bring it to the upright or neutral position. Turret rotation can be reversed instantly without damage to the fluid power mechanism.

OPERATING INSTRUCTIONS

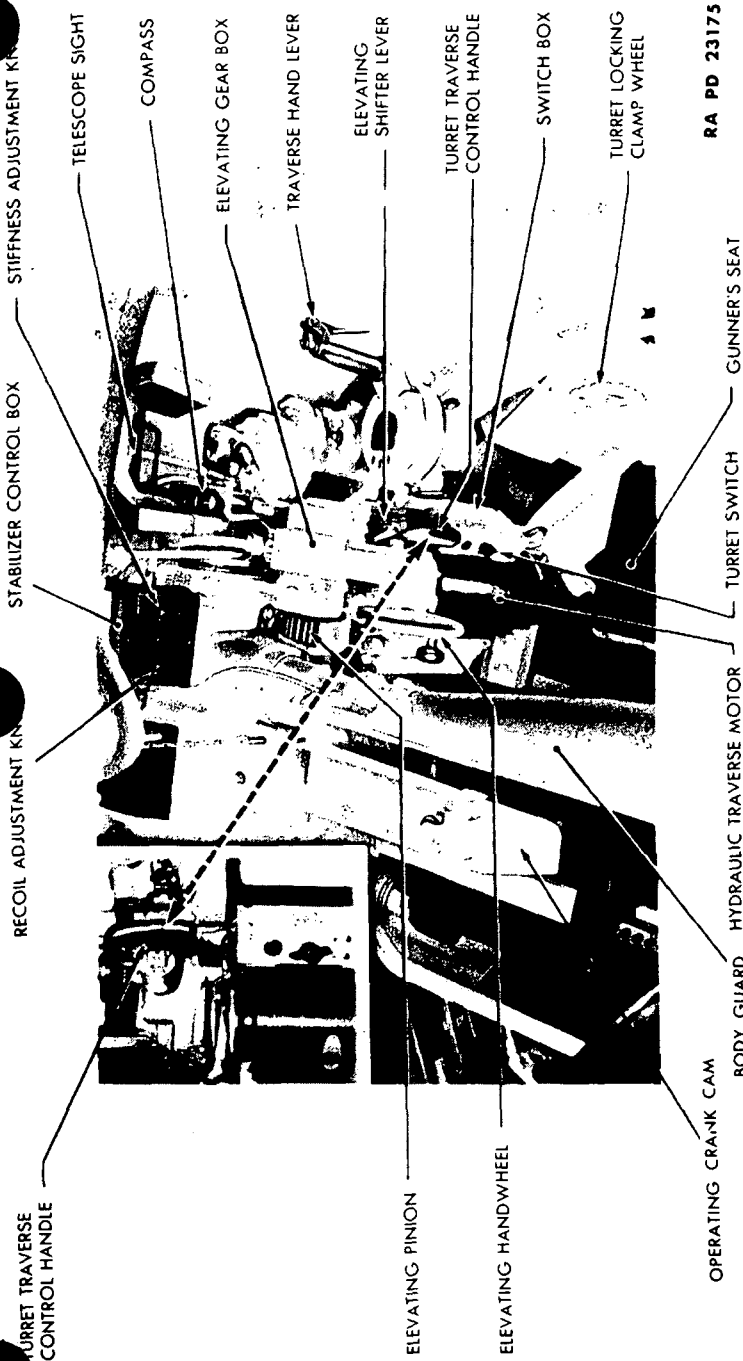

Figure 195—Hydraulic Traversing Mechanism Installed in Tank

TANK, MEDIUM, M4A3

b. **Manual Operation** (fig. 195). If electric power fails, or hydraulic traverse system will not operate, due to some other cause, the turret can be rotated by the manual drive handle located on top of gear mechanism to the right of gunner's seat. Before traversing turret, be sure the doors for the driver and assistant driver are closed. Disengage the turret positive locking clamp by turning handwheel to the left or counterclockwise, as far as possible. Move gear-shift lever under gear mechanism to the "DOWN" position. It may be necessary to turn slightly the manual drive handle on top of gear mechanism to engage gears. The manually operated gears are then engaged with the turret ring gear and pinion. Grip the manual drive handle and its associate lever on top of gear mechanism in front of gunner to release brake in gearbox. Turn manual drive handle to the right, or clockwise, to rotate turret clockwise, and to the left, or counterclockwise, to rotate the turret counterclockwise. The rate of speed of turret rotation is dependent upon the position of the control handle from the neutral position. If the manual drive handle on gear mechanism turns freely and fails to move the turret, the shift lever under gear mechanism is in the "UP," or power-traverse position and should be moved to the "DOWN" or manual-traverse position. *NOTE: If the tank is on an incline, when the positive locking clamp is disengaged, and the shift lever is in the "UP" or power-traverse position, when the traverse pump is not in operation, the unbalanced load of the gun will cause the turret to drop rapidly until the gun reaches the lowest position. Always traverse the turret 360 degrees manually, with the manual-drive handle on gear mechanism, to be sure the turret is free.*

171. ELEVATING OR DEPRESSING THE GUN.

a. The gun (fig. 193) is elevated or depressed by turning the elevating handwheel. Maximum elevation is 25 degrees and maximum depression is 10 degrees. If turning the handwheel does not elevate or depress the gun, the hand elevating gears are out of mesh. To put gears in mesh for manual operation, press the release lever down (fig. 197) and move the elevating clutch lever to the right or away from the gun mount. It may be necessary to bear down on the shoulder guard to engage the gears.

172. OPERATING THE STABILIZER.

a. **Purpose.** The stabilizer holds the 75-mm gun and the cal. .30 machine gun in the combination gun mount at a predetermined elevation while the tank is in motion. The stabilizer controls gun movements in a vertical plane caused by the pitching of the tank. The stabilizer has no control of movement in a horizontal plane due to the roll of the tank.

OPERATING INSTRUCTIONS

- A — FLEXIBLE SHAFT
- B — CLAMP
- C — MOUNTING SCREW
- D — OIL RESERVOIR
- E — FILLER PLUG
- F — SIGHT GLASS
- G — DRAIN PLUG
- H — TOP COVER SCREW
- J — CONTROL BOX
- K — STIFFNESS RHEOSTAT
- L — PILOT LIGHT
- M — RECOIL RHEOSTAT

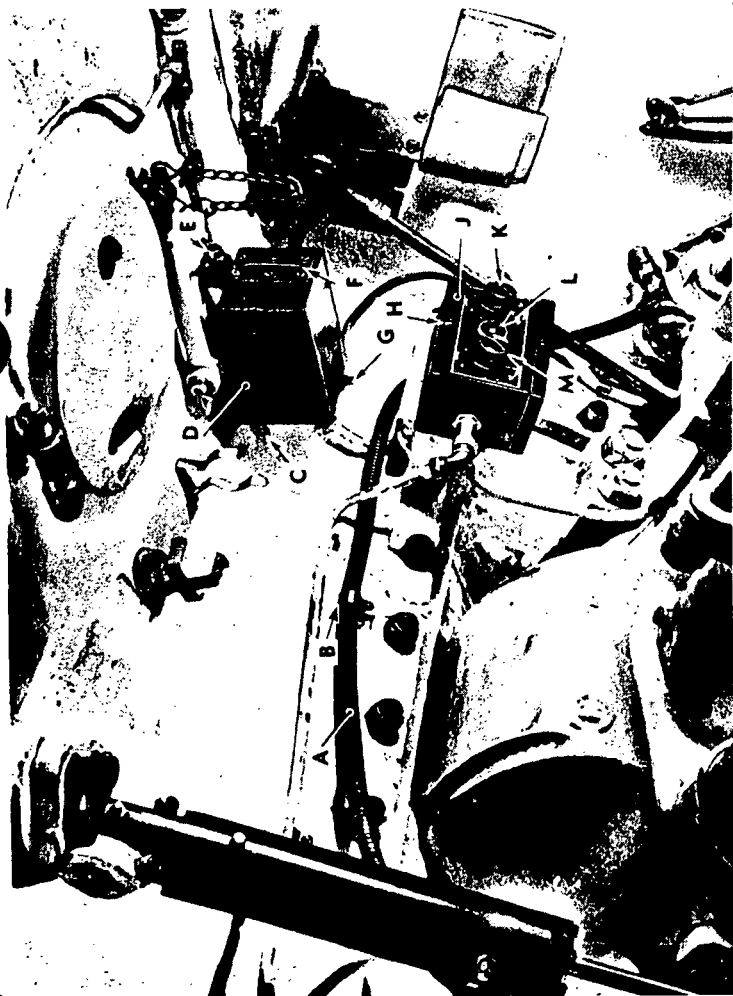

RA PD 312516

Figure 196—Stabilizer Parts Installed (1)

TANK, MEDIUM, M4A3

- A — END COVER
- B — GEAR BOX
- C — SPRING OILER
- D — MULTI-PRONG PLUG
- E — GEAR BOX CLAMP
- F — DUST SHIELD
- G — GYRO CONTROL
- H — OIL GEAR TRAVERSE
- J — STABILIZER SWITCH
- K — FIRING SWITCH
- L — TURRET SWITCH
- M — WESTINGHOUSE MOTOR
- N — OIL PUMP

RA PD 312517

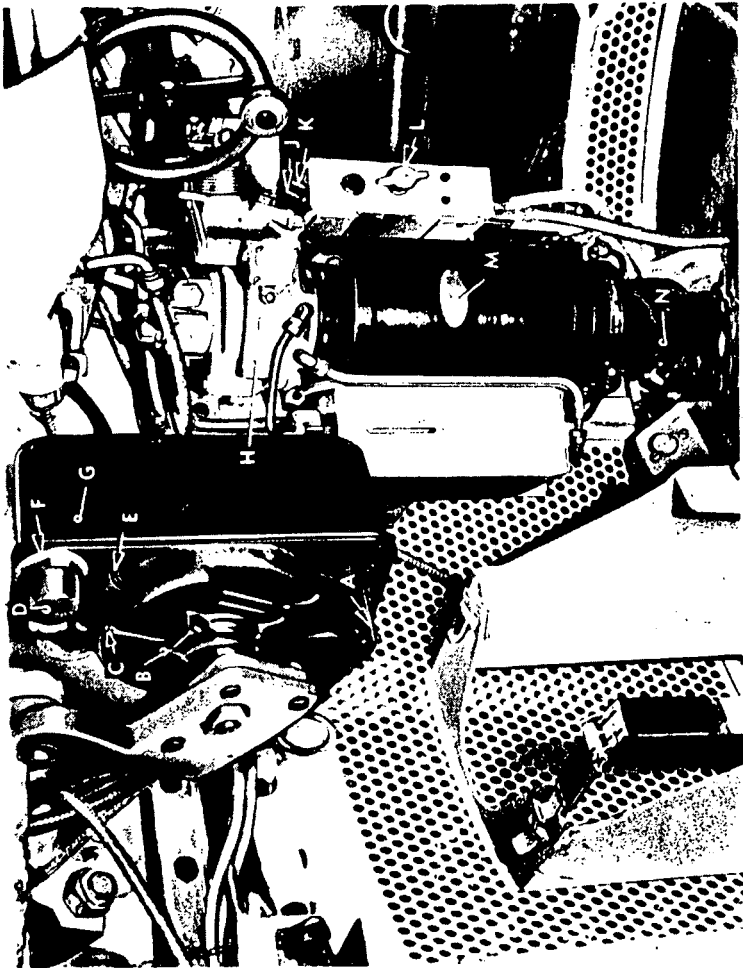

Figure 197—Stabilizer Components Installed (2)

OPERATING INSTRUCTIONS

b. **Control of the Gun.** When the stabilizer is in operation, the guns are elevated or depressed in the usual manner by turning the elevating handwheel. As the angular relation between the guns and the gyro control is changed, the guns automatically take up the new desired elevation. When the tank is in motion, the guns are automatically kept at the set elevation within close limits, making it necessary to elevate or depress the guns only when the target moves, when the tank changes direction, or when the elevation of the tank (other than that caused by normal pitching) is changed. The elevating handwheel should not be turned after the guns have reached their limits of travel in elevation or depression. Further turning of the handwheel when the guns are against either stop will result in excessive overload on the tank battery.

c. **Starting the Stabilizer.**

(1) Be sure the oil reservoir (fig. 196) shows at least two-thirds full of hydraulic oil.

(2) Take the hand elevating gears out of mesh by pushing the release lever down and moving the elevating clutch lever toward the gun mount (fig. 193). It may be necessary to rotate the elevating handwheel, slightly, to remove tension from the elevating pinion.

(3) Adjust the gyro control to an approximate vertical position (fig. 197). **CAUTION:** *This operation is necessary to prevent the 75-mm gun from moving sharply into the elevated or depressed position caused by the displacement of the gyro control in other than a vertical position.*

(4) Turn the master turret electrical switch to "ON" position (fig. 197).

(5) Turn the stabilizer switch to the "ON" position (fig. 197).

(6) In cold weather, permit the oil to warm up. In subzero weather, allow ½-minute running time for each degree of temperature below zero. For example, a total running time of 10 minutes at 20 degrees below zero.

d. **Adjusting the Stiffness Rheostat.** Starting at zero, slowly turn the knob clockwise (fig. 196). A vigorous vibration of the gun indicates too "stiff" an adjustment. Failure of the gun to remain in its aimed or set position indicates insufficient stiffness. If the gun starts to vibrate after the stiffness control knob is turned, decrease the adjustment by turning the knob in the opposite direction until the vibration is eliminated. It may be necessary to change the stiffness adjustment from time to time as the viscosity of the oil and the tank battery voltage change.

e. **Adjusting the Recoil Rheostat** (fig. 196). The recoil rheostat adjustment prevents the breech from dropping when the gun

TANK, MEDIUM, M4A3

recoils. Make the recoil rheostat adjustment by trial and error while the gun is being fired. Set the recoil adjuster knob on No. 5 position. If the breech of the gun drops during recoil, turn the recoil adjustment knob gradually to the right, or clockwise, until a point is reached where the gun will keep its angular setting during recoil.

f. Checking Stabilizer Operation. Check the stabilizer for effectiveness accuracy before the tank is used in combat, in the following manner:

- (1) Recheck the stiffness rheostat adjustment.
- (2) Choose a suitable location for a trial run of the tank. The terrain should be average rough, with no slopes, and sufficient acreage to permit adequate cruising time for the test run.
- (3) Operate the tank at a normal and constant speed with the guns aimed at a fixed target.
- (4) Observe the target through the telescopic sight in the gunner's periscope or in the direct-sighting telescope.
- (5) If it is possible to hold the gun on the target within close limits, using the handwheel, the stabilizer is operating satisfactorily.

173. OPERATING THE BREECH MECHANISM.

a. Opening Breech. To open the breech, grasp the grip portion of the breech-operating handle (fig. 198), release the latch in the grip, and pull toward the right and to the rear. This moves the breechblock to the right and thus opens the breech. **CAUTION:** *Keep hands out of gun when breech is open. Return operating handle to the closed position immediately after opening breech in order to avoid injury to personnel and the mechanism.*

b. Closing Breech. Close the breech by unlatching the operating handle and pull rearward and to the right. Bear sufficient weight on the handle to overcome the tension of the closing spring and release the extractors from their locking position by pressing them forward with the base of an empty cartridge case. The breechblock is then free to be eased into its closed position by means of the operating handle which should finally be latched in place. **CAUTION:** *Do not use hands to release the extractors.*

c. Semiautomatic Operation. Under ordinary circumstances it will be necessary to open the breech only at the start of firing operations. A cam attached to the crank arm within the breech mechanism is operated by the recoil of the gun after firing, and serves to open the breech and extract the empty cartridge case during the recoil and return of the gun to battery.

OPERATING INSTRUCTIONS

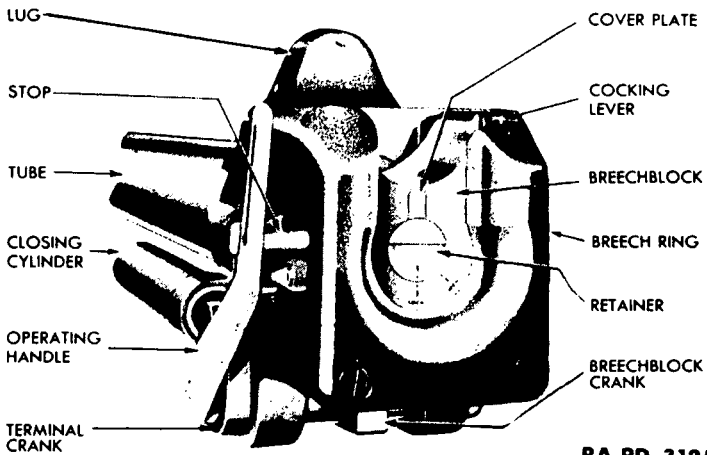
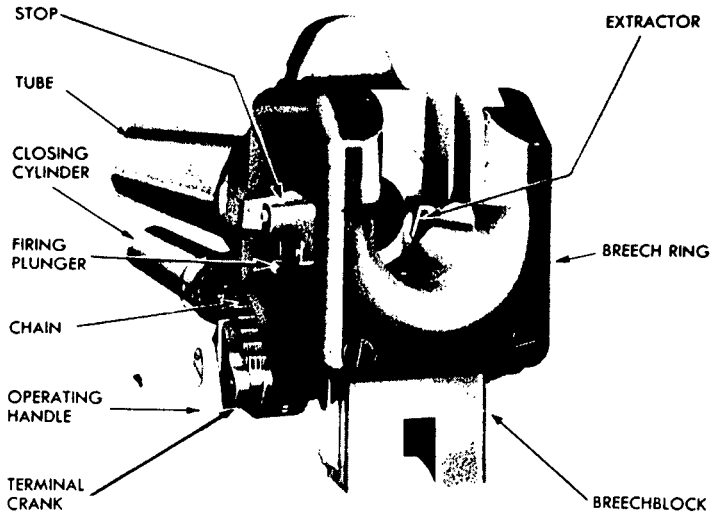

RA PD 312518

Figure 198—75-mm Gun M3—Breech In Open and Closed Position

TANK, MEDIUM, M4A3

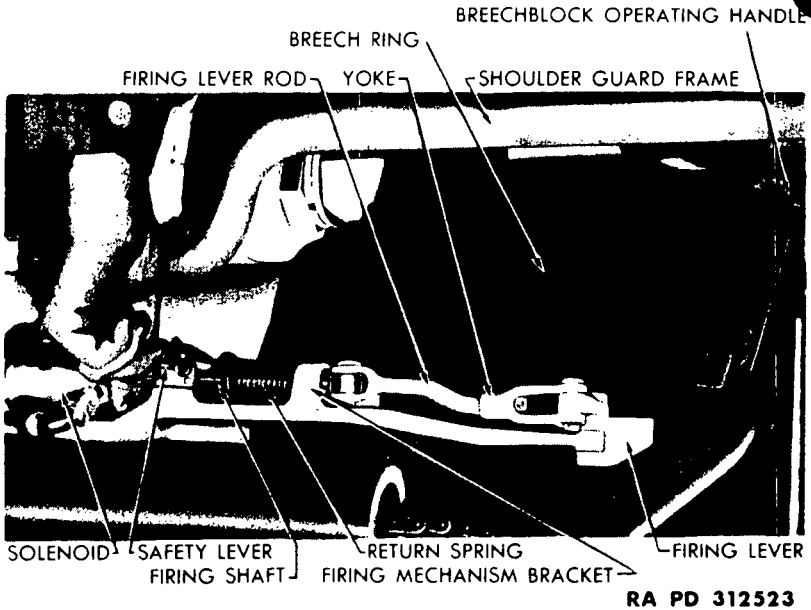

Figure 199—Placing Safety Lever Forward in Safe Position

174. LOADING THE GUN.

a. Before loading, open breech and examine the bore of the gun to see that it is clear and free from foreign material. Be sure to return operating handle to its closed position.

b. To load the gun, place a round in the breech with the nose protruding in the bore, and impel the round into the chamber with sufficient force to cause the flange of the cartridge case to drive the extractors forward, and automatically close the breech. *NOTE: The loader's hand should be moving toward the left as he shoves the projectile home, in order to clear the breechblock as it is automatically closed.*

175. FIRING THE GUN.

a. The 75-mm gun can be fired either electrically or manually in case of failure of the electrical system. A firing switch is located in the turret control box and controls the circuit to the two foot-operated switches (fig. 200) convenient to the gunner's foot located on the turret floor. The right switch operates the 75-mm gun solenoid and the left one operates the cal. .30 machine gun in the combination gun mounts. The firing pedal is used to fire the 75-mm gun manually.

OPERATING INSTRUCTIONS

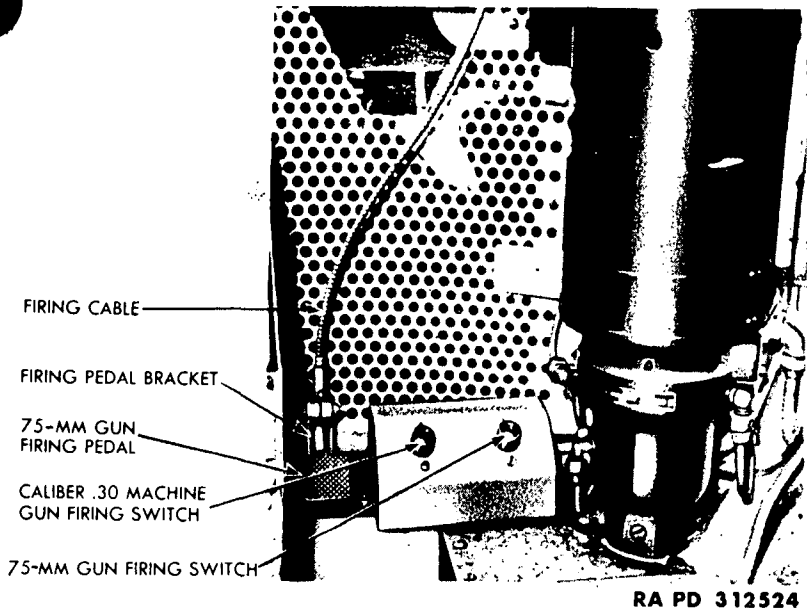

RA PD 312524

Figure 200—Firing Switches and Firing Pedal

h. To fire the 75-mm gun electrically, turn the firing switch in the control box to the "ON" position. Place the safety lever toward the rear in firing position (fig. 199). To fire the 75-mm gun depress the floor switch for the 75-mm gun. The cal. .30 machine gun firing switch on the turret floor fires the machine gun when depressed. If the electrical method fails to fire the 75-mm gun, the firing pedal may be used to fire the gun manually.

c. If the gun fails to fire using either electrical or manual means, the position of the safety lever should be checked. Failure to fire may be due to the gun staying out of battery, failure of the firing mechanism, failure of the breech to close, or defective ammunition. If the gun is in battery, recock by means of the cocking lever, located on the top rear wall of the breech ring, and attempt to fire. **CAUTION:** *In case of a misfire, open the firing switch immediately before recocking.* If the gun still fails to fire after three attempts, wait 30 seconds before opening the breech; then remove round, reload, and attempt to fire again. After the need for firing is completed, throw the firing switch to the "OFF" position and place safety lever in "SAFE" position.

TANK, MEDIUM M4A3

176. PLACING THE GUN IN TRAVELING POSITION.

- a. Place the gun in traveling position by releasing traveling bar from stowage position on roof of turret and attaching it to the cradle yoke by means of the pin.
- b. Place safety lever in forward safe position. Check to see if the breech is clear and that a round of ammunition has not been left in the breech.
- c. Clean and lubricate gun and install muzzle and breech covers.
- d. Lock the turret in traveling position by turning the wheel of the turret clamp, all the way to the right or clockwise.

Section XXXIII

SIGHTING AND FIRE CONTROL EQUIPMENT

177. CHARACTERISTICS.

a. The sighting and fire control equipment for the 75-mm gun used in the Medium Tank M4 series includes the Telescope M70F illuminated by Instrument Light M32, Periscope M4A1 with Telescope M38A2 or Periscope M10C, Elevation Quadrant M9 illuminated by Instrument Light M30, and Fuze Setter M14.

178. TELESCOPE M70F.

a. The Telescope M70F (fig. 201) is used for direct laying of the 75-mm gun. The telescope is mounted in a front and rear bracket on the right-hand side of the gun mount, and moves with the gun. The reticle pattern (fig. 202) is graduated for Armor-Piercing Capped Projectile M61, fired with a muzzle velocity of 2030 feet per second, plus 0.3 mils jump. The graduations are based on data contained in firing table 75-AD-5, C1. The cross represents zero range and zero deflection for use in lining up the telescope with the gun when performing the bore sighting adjustment.

b. To use the Telescope M70F for direct laying, bring the image of the target to the point on the reticle which represents the required range and deflection by rotating the elevating handwheel and traversing the turret. The range markings are in hundred of ya

SIGHTING AND FIRE CONTROL EQUIPMENT

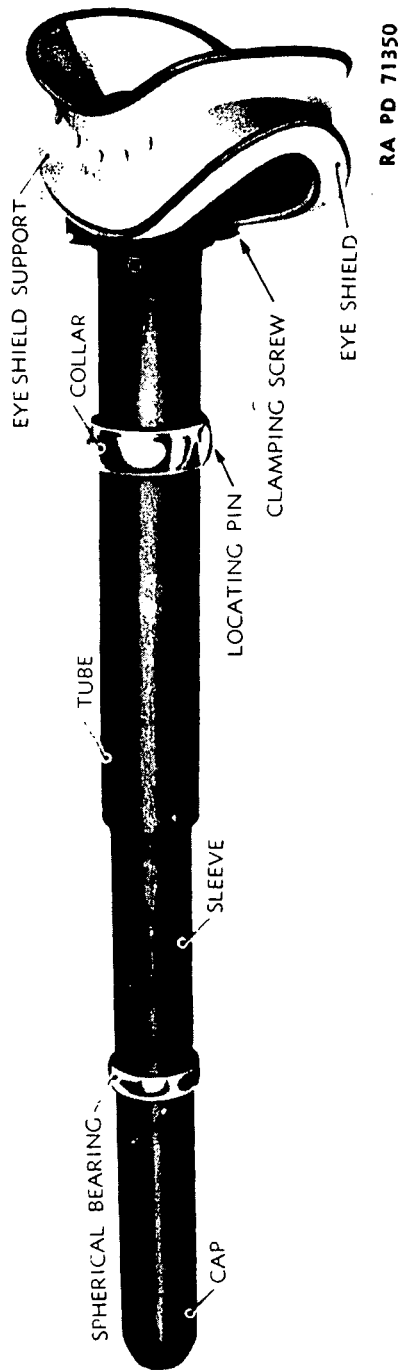

RA PD 71350

Figure 201—Telescope M70F

TANK, MEDIUM, M4A3

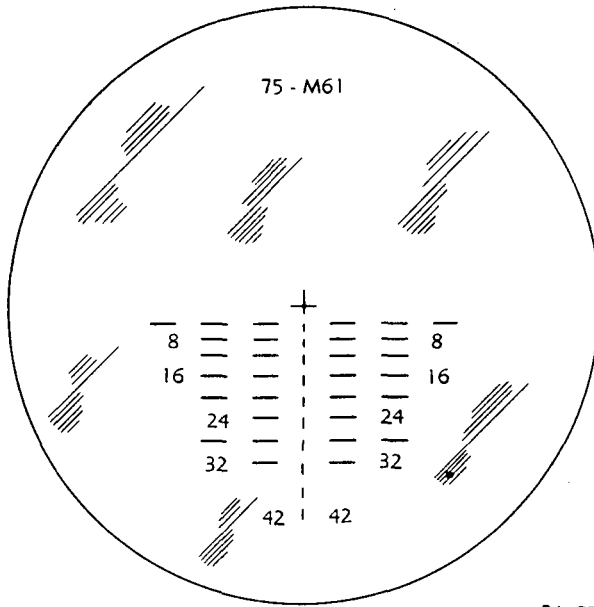

RA PD 28938

Figure 202—Reticle Pattern of Telescope M70F

Each horizontal line and each space represents a deflection of 5 mils. This deflection is equivalent to a lead of 2 yards at 400 yards range; 4 yards at 800 yards range; 6 yards at 1,200 yards range, etc. The gunner's eye should be approximately $1\frac{1}{4}$ inches from the telescope eyelens when observing.

179. PERISCOPE M4A1 WITH TELESCOPE M38A2.

- a. For description and use of the Periscope M4A1 refer to paragraph 198.
- b. The reticle pattern for the Telescope M38A2 is the same as that shown in figure 202 and described in paragraph 178.

180. PERISCOPE M10C.

- a. For description and use of the Periscope M10C refer to paragraph 199.
- b. The reticle pattern for the one-power optical system is the same as that shown in figure 223, and the reticle pattern for the six-power system is the same as that shown in figure 202.

AMMUNITION

B1. ELEVATION QUADRANT M9, FUZE SETTER M14 AND BORE SIGHTING ADJUSTMENT.

a. The Elevation Quadrant M9 is described in paragraph 200; the Fuze Setter M14 is described in paragraph 201; and the bore sighting adjustment is described in paragraph 202.

**Section XXXIV
AMMUNITION**

182. AUTHORIZED AMMUNITION.

a. Ammunition authorized for the 75-mm gun, M3, is listed in Table I. Standard nomenclature which completely identifies the ammunition is used in the listing. Identification is provided for by painting and marking on the rounds themselves and on all packing.

TABLE I. AUTHORIZED AMMUNITION¹

Nomenclature	Action of Fuze	Approx. Weight of Projectile as Fired (lb)
Service Ammunition		
PROJECTILE, fixed, A.P.C., M61A1, w FUZE, B.D., M66A1, and TRACER, 75-mm gun	Delay	14.96
PROJECTILE, fixed, A.P.C., M61, w FUZE, B.D., M66A1, and TRACER, 75-mm gun	Delay	14.96
PROJECTILE, fixed, A.P.C., M61, w TRACER, 75-mm gun	None	14.40
SHELL, fixed, H.E., M48, supercharge, w FUZE, P.D., M48, 75-mm gun ³	SQ & 0.05-sec. delay ⁴	14.60
SHELL, fixed, H.E., M48, supercharge, w FUZE, P.D., M48A1, 75-mm gun ³	SQ & 0.15-sec. delay ⁴	14.60
SHELL, fixed, H.E., M48, supercharge, w FUZE, P.D., M48A2, SQ & 0.05-sec. delay, 75-mm gun ³	SQ & 0.05-sec. delay ⁴	14.60
SHELL, fixed, H.E., M48, normal charge, w FUZE, P.D., M48, 75-mm gun ³	SQ & 0.05-sec. delay ⁴	14.60

¹ See footnotes at end of Table.)

TANK, MEDIUM, M4A3

TABLE I. AUTHORIZED AMMUNITION¹—(Contd.)

Nomenclature	Action of Fuze	Approx. Weight of Projectile as Fired (lb)
Service Ammunition—(Contd.)		
SHELL, fixed, H.E., M48, normal charge, w FUZE, P.D., M48A1, 75-mm gun ³	SQ & 0.15-sec. delay ⁴	14.60
SHELL, fixed, H.E., M48, normal charge, w FUZE, P.D., M48A2, SQ & 0.15-sec. delay, 75-mm gun ³	SQ & 0.15-sec. delay ⁴	14.60
SHELL, fixed, H.E., Mk. I, flashless, reduced charge, unfuzed, 75-mm gun (adapted for FUZE, P.D., M46 or M47) ⁴	SQ (M46), or delay (M47)	12.41
SHELL, fixed, H.E., Mk. I, flashless, unfuzed, 75-mm gun (adapted for FUZE, P.D., M46, or M47) ^{5 6}	SQ (M46), or delay (M47)	12.41
SHELL, fixed, H.E., Mk. I, reduced charge, unfuzed, 75-mm gun (adapted for FUZE, P.D., M46 or M47) ⁵	SQ (M46), or delay (M47)	12.41
SHELL, fixed, H.E., Mk. I, unfuzed, 75-mm gun (adapted for FUZE, P.D., M46 or M47) ^{5 6}	SQ (M46), or delay (M47)	12.41
SHELL, fixed, smoke, phosphorus, WP, M64, w FUZE, P.D., M57, 75-mm gun	SQ	15.25
SHELL, fixed, smoke, phosphorus, WP, Mk. II, normal charge, unfuzed, 75-mm gun (adapted for FUZE, P.D., M46)	SQ	12.82
SHELL, fixed, smoke, HC, B.I., M89, 75-mm guns, M2 and M3	None	6.61
SHOT, fixed, A.P., M72, w TRACER, 75-mm gun ²	None	13.94
Blank Ammunition		
AMMUNITION, blank (single pellet charge), 75-mm guns, M1897-16-17, and 3" field guns, M1902-04-05	—	—
AMMUNITION, blank (double pellet charge), 75-mm guns, M1897-16-17, 75-mm how., M1 and M1A1, and 3" field guns, M1902-04-05	—	—

(See footnotes at end of Table.)

AMMUNITION

TABLE I. AUTHORIZED AMMUNITION¹—(Contd.)

Nomenclature	Action of Fuze	Approx. Weight of Projectile as Fired (lb)
Drill (Dummy) Ammunition		
CARTRIDGE, drill, M7, 75-mm guns, M1897-16-17, M2, M3, and T6	—	—
CARTRIDGE, drill, M16, w FUZE, dummy, M59, 75-mm gun	—	—

A.P.—armor-piercing
 A.P.C.—armor-piercing-capped
 B.D.—base-detonating

B.I.—base-ignition
 H.E.—high-explosive
 P.D.—point-detonating

SQ—superquick

- ¹—Service rounds have been manufactured with both brass and steel cases. Nomenclature of steel case rounds includes the words "steel case" immediately following the model designation. The words are also stenciled on packing boxes and crates, when applicable. Steel cartridge cases are signified in the stamping on the base of the case by the addition of "B1" to the model designation of the case.
- ²—This round may be issued and used for target practice.
- ³—In future manufacture, supercharge H.E. rounds requiring the M48-series fuzes will be assembled with the M48 or M48A2 with 0.05 second delay; rounds with normal or reduced propelling charge will be assembled with the M48A1 or M48A2 with 0.15 second delay. Only rounds fitted with the M48 or M48A2 (0.05 second delay) will be issued for oversea shipment for tank use. See note 3 for identification of the M48A2 fuze.
- ⁴—The delay of FUZE, P.D., M48, is 0.05 second; of FUZE, P.D., M48A1, 0.15 second. The M48A2 fuze may have either 0.05 second or 0.15 second delay, depending on the lot. Provision is made for identification by stamping the length of delay in seconds on the M48A2 fuze immediately following the model number. Thus, M48A2 fuzes with the 0.05 second delay element will have stamped on the body "FUZE, P.D., M48A2 (.05 SEC.); M48A2 fuzes with 0.15 second delay will be stamped "FUZE, P.D., M48A2 (.15 SEC.)."
- ⁵—For restrictions on issue and use of FUZE, P.D., M46, and M47, for training, see OFSB 3-3.
- ⁶—Issue for training will be from existing supply.

183. PREPARATION FOR FIRING.

a. **Fuzed Rounds.** Fuzed rounds authorized for this gun are ready for firing as removed from packing (including the U-shaped packing stop), except for setting the M48 point-detonating fuze of the M48 high-explosive rounds for the required action. As shipped, FUZE, P.D., M48, M48A1, and M48A2 are set for superquick action (SQ), that is, the slot in the setting screw is parallel to the axis of the fuze and in line with "SQ." To adjust for delay action, the setting screw should be turned by means of the screwdriver end of WRENCH, fuze, M7A1, or similar instrument, so that the slot is alined with "DELAY," that is, at right angles to the axis of the fuze. (Delay action is pro-

TANK, MEDIUM, M4A3

vided for in the fuze by a delay pellet.) The setting may be n or changed at will, and can be done in the dark by noting the position of the slot in the setting sleeve.

b. Unfuzed Rounds. In the case of unfuzed rounds, it is necessary to remove the adapter closing plug from the projectile and to assemble the required fuze. To assemble FUZE, P.D., M46 and FUZE, P.D., M47, to the projectile, proceed as follows:

- (1) Remove the closing plug from the projectile.
- (2) Inspect the fuze cavity and threads to make certain that there is no foreign matter present which would interfere with proper assembly of the fuze.
- (3) Screw the fuze slowly into the adapter by hand. (It is essential that the felt washer provided with the fuze be under the detonator socket flange when the fuze is screwed into the adapter.)
- (4) Tighten with fuze wrench, whereupon the fuzes are then ready for firing.

PART FOUR—AUXILIARY EQUIPMENT—(Contd.)**C—ARMAMENT****76-MM GUN M1A1, M1A1C, OR M1A2 IN
THE COMBINATION GUN MOUNT M62****Section XXXV****INTRODUCTION****184. SCOPE.**

a. Part Four-C contains instructions for the operation of the 76-mm Gun M1A1, M1A1C, or M1A2 in the Combination Gun Mount M62. It lists the authorized ammunition for the gun and contains information on the sighting equipment. Refer to section IX for lubrication instructions on the armament.

b. The other armament in the vehicle (fig. 203) is as follows: Cal. .30, M1919A4 Machine Gun mounted in the Combination Gun Mount M62; Cal. .30 M1919A4 Machine Gun mounted in a bow mount in the right front of the vehicle (fig. 204); Cal. .50, HB, M2 Machine Gun mounted in a bracket-type mount on a revolving turret hatch (fig. 205); and a 2-inch Mortar M3 located in a fixed mount in the turret to the left of the combination gun mount (fig. 206)

INTRODUCTION

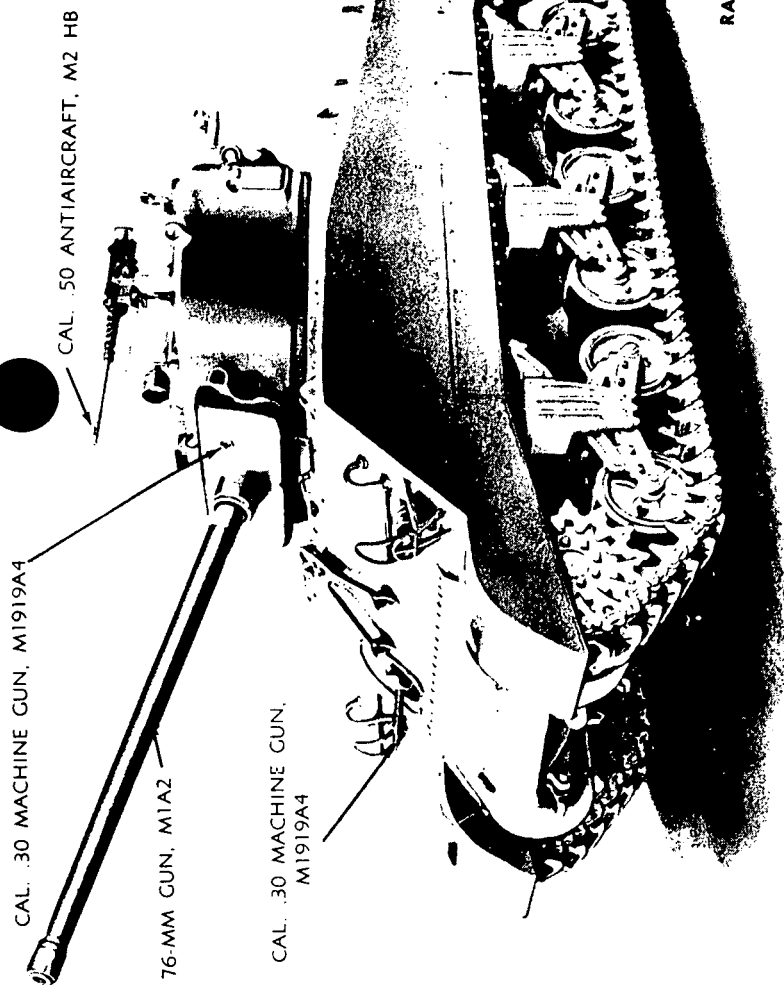

RA PD 19715

Figure 203—Medium Tank M4—Guns Installed

TANK, MEDIUM, M4A3

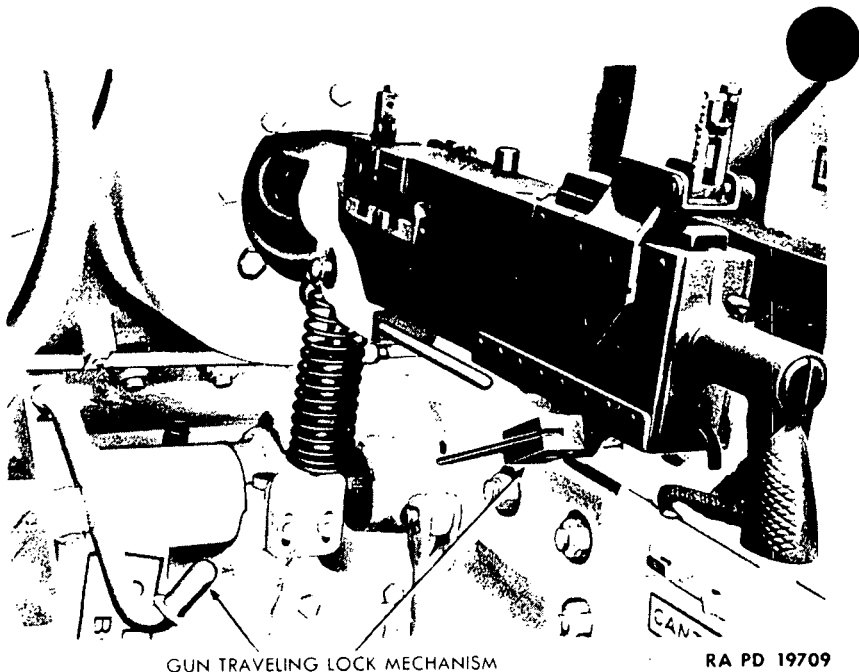

GUN TRAVELING LOCK MECHANISM

RA PD 19709

Figure 204—Cal. .30 M1919A4 Machine Gun Installed in Bow Mount

185. CHARACTERISTICS.

a. The armament is employed chiefly against enemy tanks and other ground objectives. The turret can be traversed 360 degrees manually or by a hydraulic traversing mechanism. The 76-mm gun can be elevated 25 degrees and depressed 10 degrees. The cal. .30 machine gun in the combination gun mount is elevated and traversed with the 76-mm gun.

b. The cal. .30 machine gun in the bow mount is elevated and traversed manually and fired by the conventional trigger. Refer to FM 23-50 for complete information on its operation.

c. The cal. .50 machine gun is employed chiefly against enemy aircraft and is elevated and traversed manually and fired by the conventional trigger. The machine gun can be traversed independently of the turret. Refer to FM 23-65 for complete information on its operation.

d. The 2-inch mortar is used to lay a smoke screen while the tank is advancing. It is mounted in a fixed mount, has no elevation or depression, and traverses with the turret. Refer to TM 9-293 for complete information on its operation.

INTRODUCTION

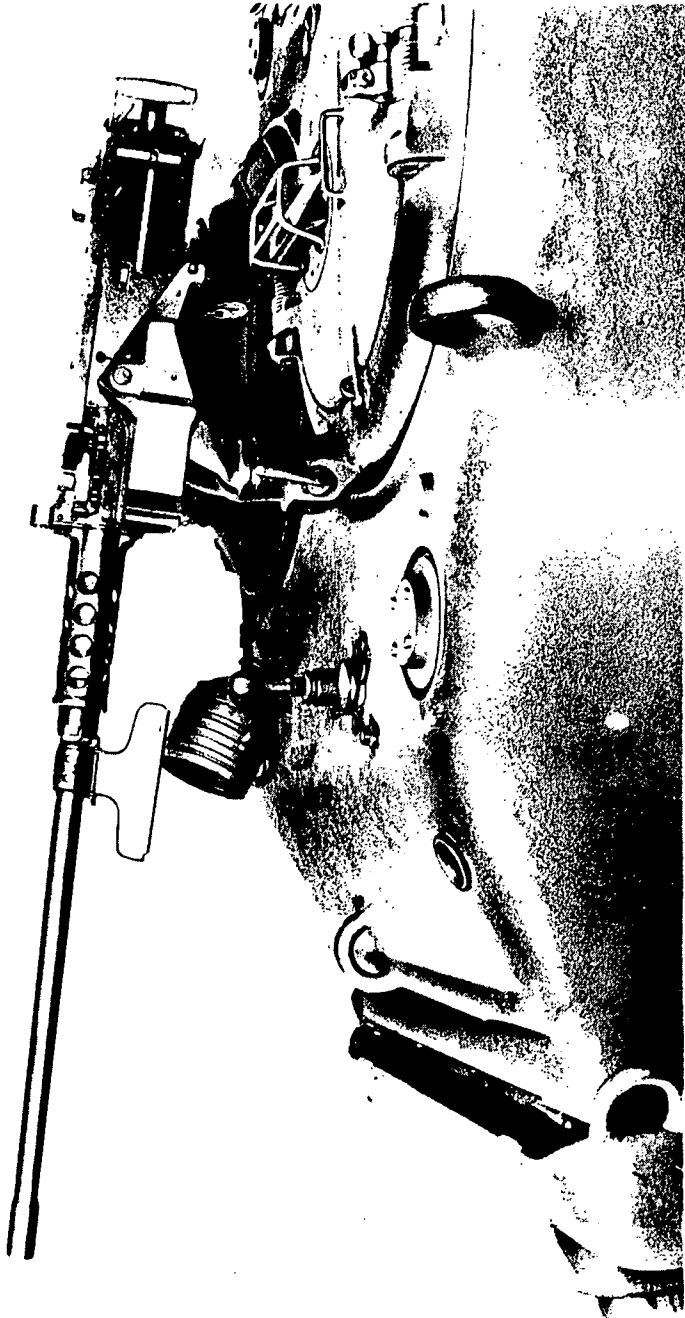

RA PD 19716

Figure 205—Cal. .50 HB, M2 Antiaircraft Gun Installed

TANK, MEDIUM, M4A3

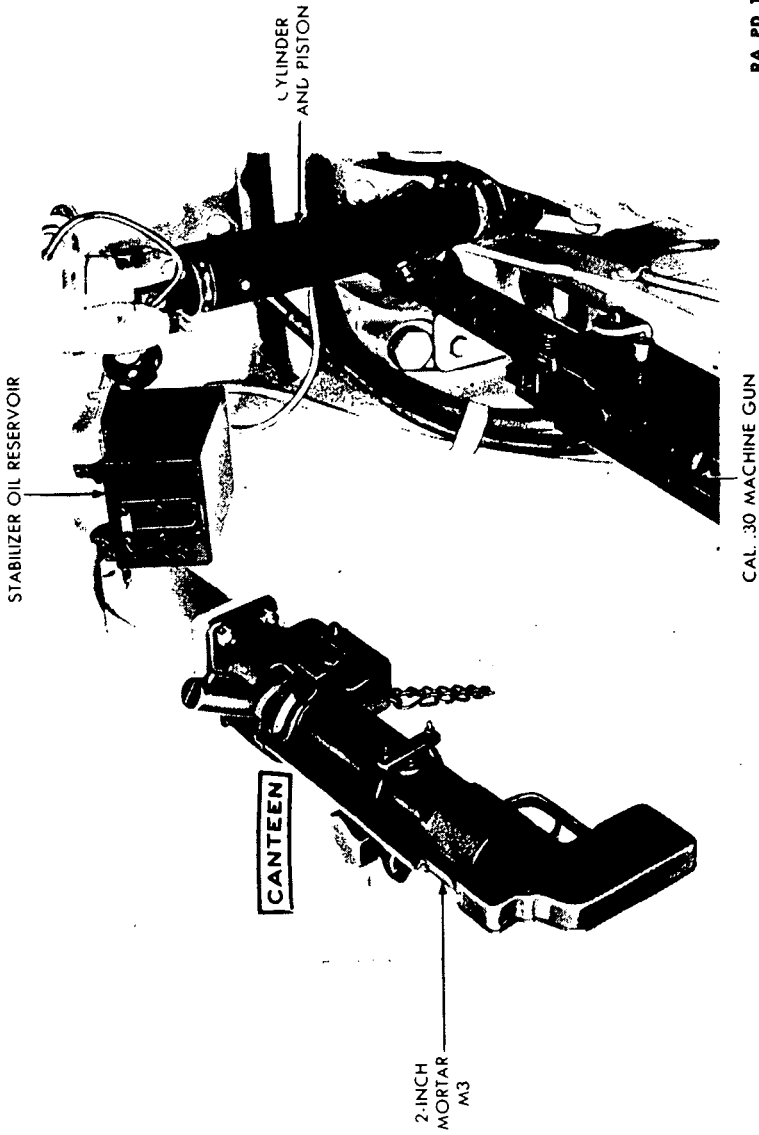

RA PD 19718

Figure 206—2-inch Mortar M3 Installed

OPERATING INSTRUCTIONS**186. DIFFERENCES AMONG MODELS.**

a. There are three models of 76-mm guns which can be used in the Combination Gun Mount M62 in the Medium Tank M4 series. They are the M1A1, M1A1C, and the M1A2. The M1A1 is rifled with uniform right-hand twist, one turn in 40 calibers. The M1A1C is modified by the addition of threads at the muzzle end to take a muzzle brake. When the muzzle brake is not installed the threads will be protected by a ring. The M1A2 model has the rifling changed to uniform right-hand twist, one turn in 32 calibers with the muzzle end threaded to take the muzzle brake. If the muzzle brake is not installed, a ring is used to protect the threads. The guns will be so marked that proper identification can be made.

Section XXXVI**OPERATING INSTRUCTIONS****187. PLACING THE 76-MM GUN IN FIRING POSITION.**

Remove the muzzle cover.

b. Pull out the traveling lock pin from the cradle lock, and lock the traveling lock bar in position under turret roof (fig. 207).

c. To disengage the gun traveling lock, pull down on the spring release, and elevate the gun until it clears the lock. Swing the traveling lock down to its latched position and it will be locked in place by the traveling lock latch (fig. 208).

d. Disengage the turret lock by turning the handle, pulling it out, and rotating one-quarter turn clockwise (fig. 212).

188. INSPECTION BEFORE FIRING.

a. **Check Oil Level in Recoil Cylinder.** To check oil level, depress gun 5 degrees and remove the filling plugs (figs. 209 and 210) at the rear of each recoil cylinder. The oil level in the cylinder should reach the bottom of the hole. If oil does not reach this level, fill until level is reached. Replace plugs. The recoil mechanism uses special recoil oil for all temperatures.

b. Check path of recoil to make sure that it is free from all obstructions.

c. Open breech and inspect bore of gun for cleanliness.

Bore Sighting. Refer to paragraph 202.

TANK, MEDIUM, M4A3

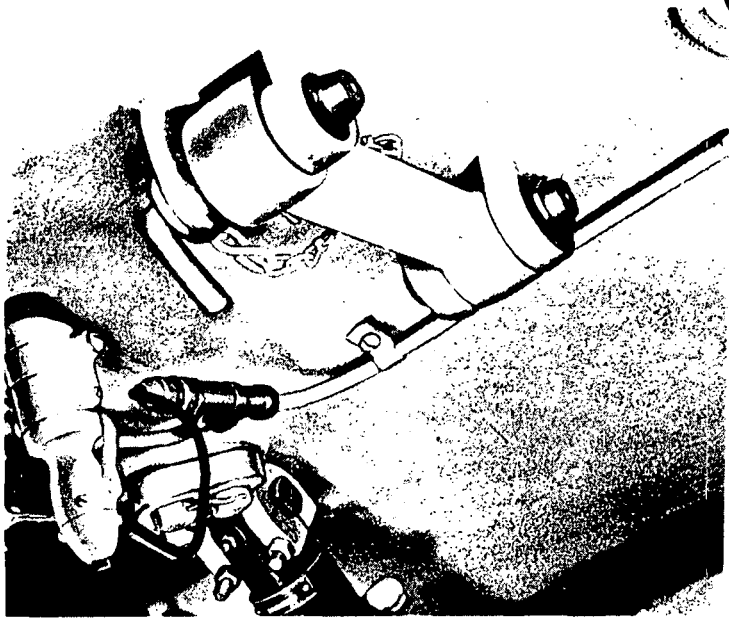

RA PD 19721

Figure 207—Cradle Traveling Lock Installed Under Roof of Turret

189. TRAVERSING TURRET.

a. **Power Operation.** Before traversing turret by means of the hydraulic mechanism, be sure the hatches for the driver and assistant driver are closed. Make sure personnel are clear of rotating parts. Move gearshift lever, in front of gunner and under traversing gear mechanism, to the "UP" position or power position (fig. 213). It may be necessary to turn, slightly, the manual traversing handle on top of traversing mechanism to engage gears. Turn master turret electrical switch to the "ON" position to start electric drive motor (fig. 214). Disengage the turret lock by turning the handle, pulling out the handle, and rotating it one-quarter turn to the left (fig. 212). **CAUTION:** *It is important to have turret lock completely disengaged before traversing turret, and to lock turret in position when the need for traversing has been completed.* The control handle on the traverse pump to the right of the gun elevating handwheel controls the speed and direction of turret rotation (fig. 213). To traverse turret to the right, rotate the control handle to the right. To traverse turret to the left, rotate the control handle to the left. The further the handle is rotated from its normal position, the faster the speed of traverse stop turret traverse, release control handle or bring it to the ne

OPERATING INSTRUCTIONS

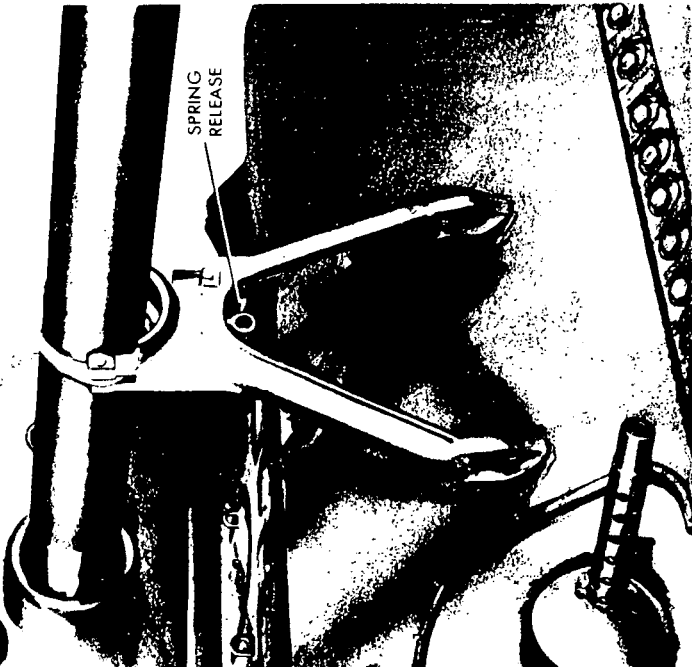
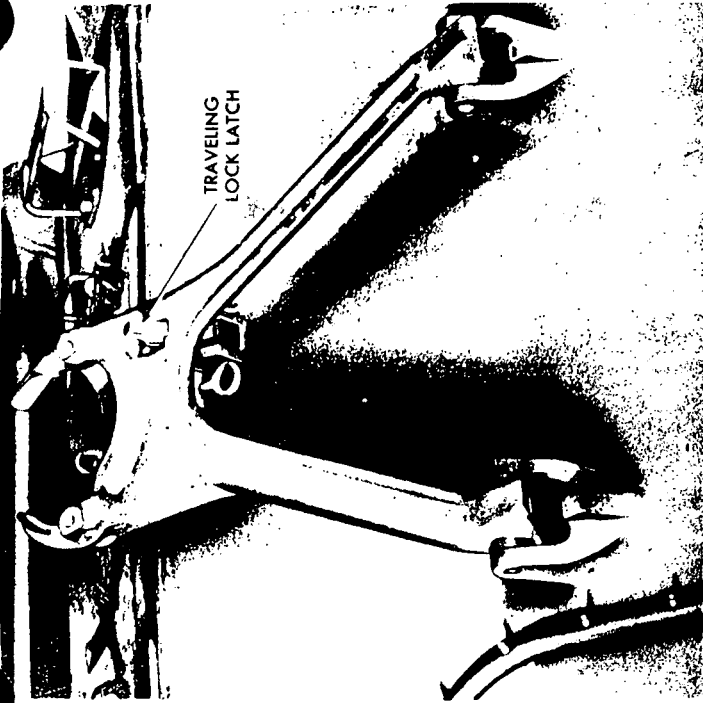

Figure 208—76-mm Gun—Traveling Lock

TANK, MEDIUM, M4A3



RA PD 19719

Figure 209—Installation of Guns Sighting Equipment in Turret

OPERATING INSTRUCTIONS

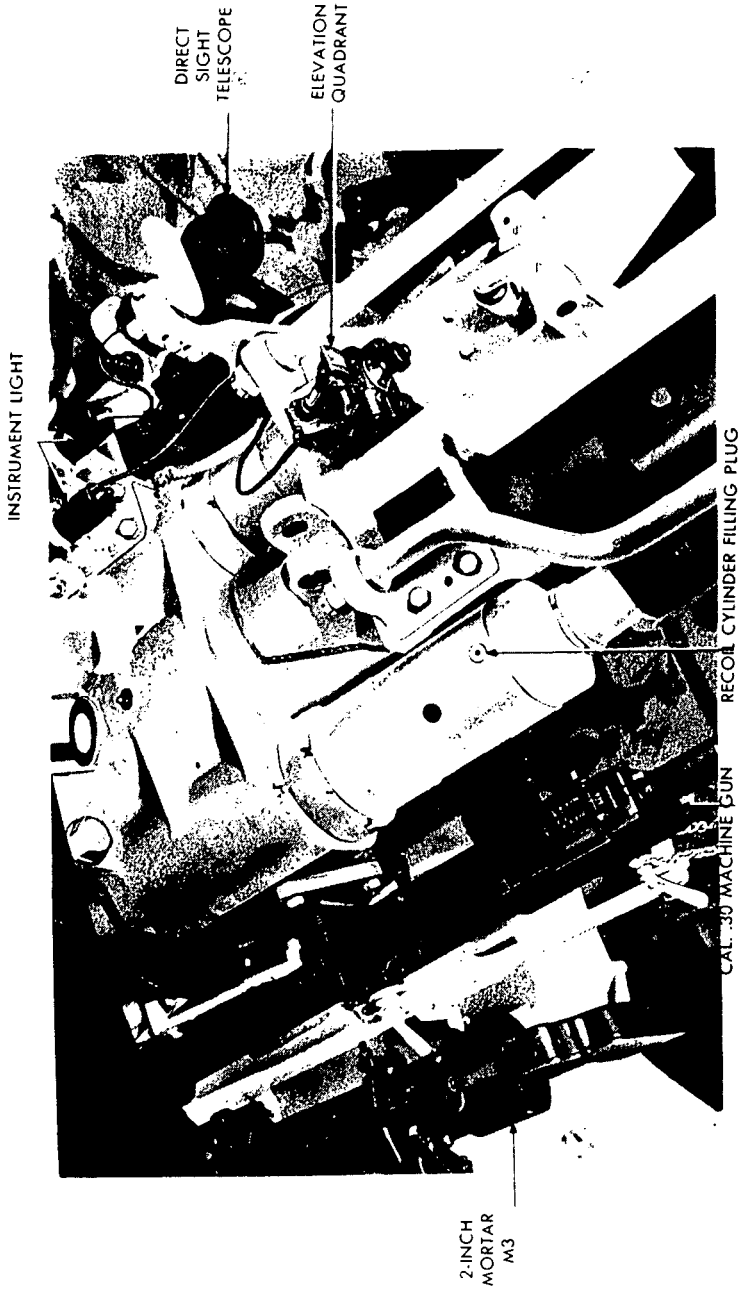

RA PD 19720

Figure 210—Installation of Guns and Sighting Equipment in Turret

TANK, MEDIUM, M4A3

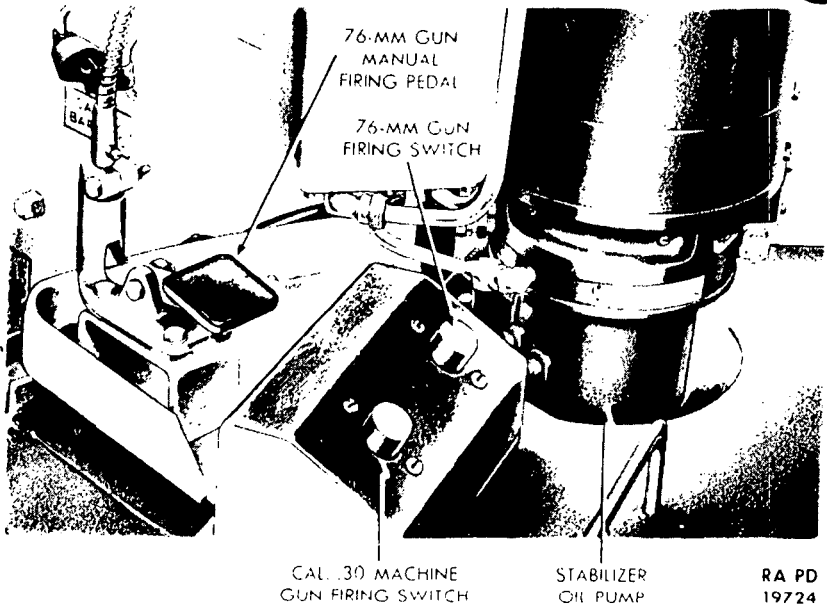

Figure 211—Turret Guns Firing Switches and Manual Firing Pedal

position. Turret rotation can be reversed instantly without damage to the power mechanism.

b. **Commander's Hydraulic Traverse Control Handle.** Mounted on a bracket on the inner right turret wall is the commander's hydraulic traverse control handle (fig. 212). If the commander so desires, he may take traverse control of the turret away from the gunner, since operation of the handle automatically cuts out the gunner's hydraulic traverse control handle. To operate the commander's hydraulic traverse control handle, depress button in top of handle and move handle forward to traverse turret counterclockwise, and toward the rear to traverse turret clockwise.

c. **Manual Operation.** If the electric power fails, or if the hydraulic traversing system will not operate due to some other cause, the turret can be rotated by the manual drive handle located on top of traversing mechanism to the right of the gunner's seat (fig. 213). Before traversing turret, be sure the hatches for the driver and assistant driver are closed. Disengage the turret lock by turning the handle, pulling out the handle, and rotating it one-quarter turn to the left (fig. 212). Move the gearshift lever under traversing mechanism to the "DOWN" position (fig. 213). It may be necessary to pull slightly, the manual drive handle on top of traversing mechanism.

OPERATING INSTRUCTIONS

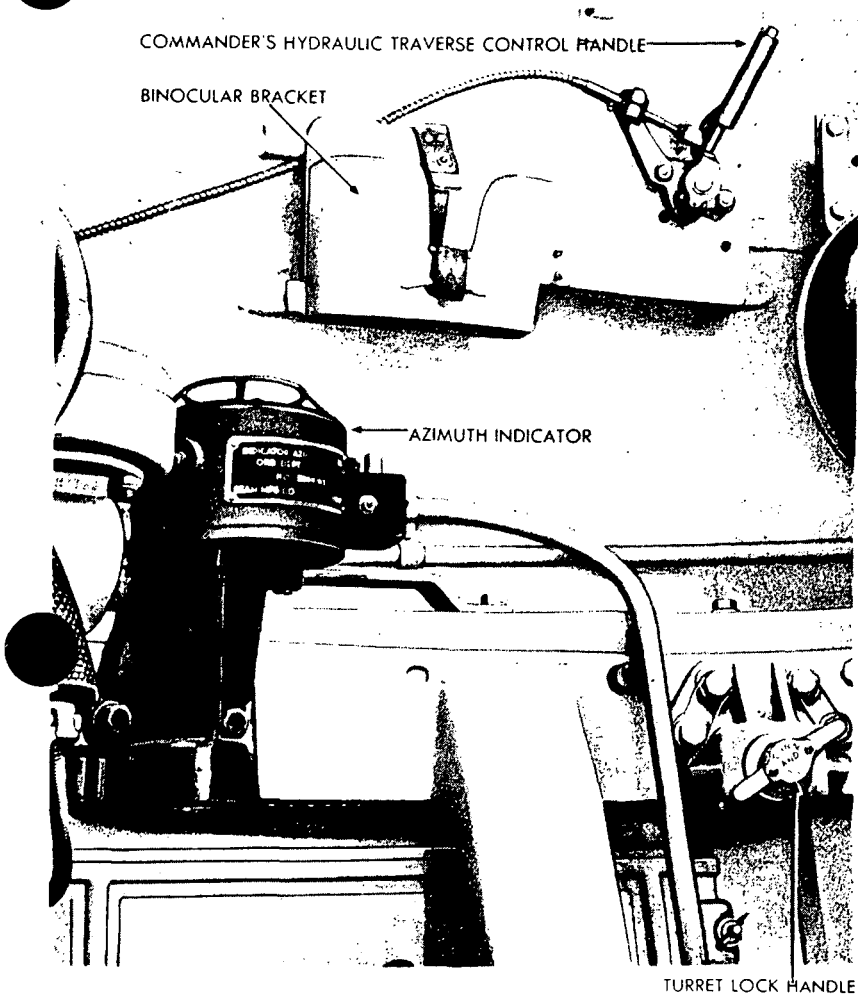

RA PD 77286

Figure 212—Turret—Inner Right Side

engage gears. Manually operated gears are then engaged with the turret ring gear and pinion. Grip the manual drive handle and its associate lever on top of gear mechanism to right of gunner to release brake in gear box. Turn manual drive handle to the right, or clockwise, to rotate turret clockwise, and to the left, or counterclockwise, to rotate the turret counterclockwise. The rate of speed of turret rotation is dependent upon the speed at which the handle is operated. The manual drive handle on traversing mechanism turns freely and

TANK, MEDIUM, M4A3

fails to move the turret, the shift lever under the mechanism to the "UP," or power traversing position, and should be moved to the "DOWN," or manual traversing position. **NOTE:** *If the tank is on an incline when the turret lock is disengaged and the shift lever not in the "UP" or power traversing position and the traversing pump is not in operation, the load of the gun will cause the turret to drift rapidly until the gun reaches the lowest position. Always traverse the turret 360 degrees manually with the manual drive handle to be sure the turret is free.*

190. ELEVATING OR DEPRESSING GUN.

a. When the elevation of the gun is being controlled manually, the stabilizer system is used to minimize the effect of backlash in the gears of the elevating mechanism. Maximum elevation is 25 degrees and maximum depression 10 degrees.

b. To use the stabilizer system to minimize backlash while elevating the gun manually, turn the stabilizer switch (fig. 213) to the "ON" position. Press the release lever down and move the elevating clutch lever (fig. 213) to the left, toward the gun mount. It may be necessary to turn the elevating handwheel slightly, to engage the gears. The gun is elevated or depressed by turning the elevating handwheel located to the right of the 76-mm gun.

191. OPERATING THE STABILIZER.

a. **Purpose.** The stabilizer holds the 76-mm gun and the cal. .30 machine gun in the combination gun mount at a predetermined elevation while the tank is in motion. The stabilizer controls gun movements in a vertical plane caused by the pitching of the tank. The stabilizer has no control of movement in a horizontal plane due to the roll of the tank.

b. **Control of the Gun.** When the stabilizer is in operation, the guns are elevated or depressed in the usual manner by turning the elevating handwheel. As the angular relation between the guns and the gyro control is changed, the guns automatically take up the new desired elevation. When the tank is in motion, the guns are automatically kept at the set elevation within close limits, making it necessary to elevate or depress the guns only when the target moves, when the tank changes direction, or when the elevation of the tank (other than that caused by normal pitching) is changed. The elevating handwheel should not be turned after the guns have reached their limits of travel in elevation or depression. Further turning of the handwheel when the guns are against either stop will result in excessive overload on the tank battery.

OPERATING INSTRUCTIONS

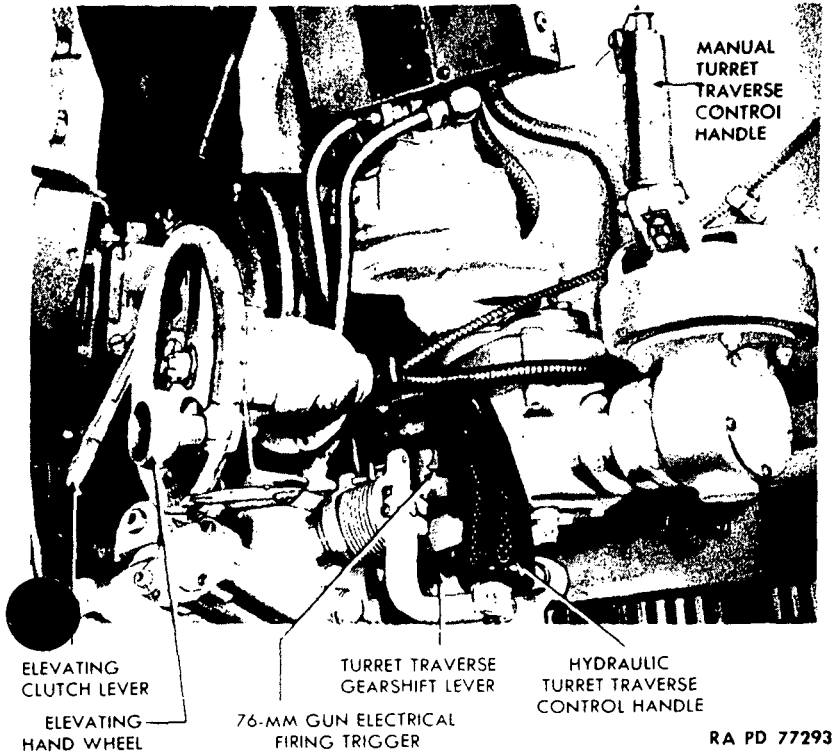

Figure 213—Turret Traverse and Elevation Controls

c. Starting the Stabilizer.

(1) Be sure the oil reservoir (fig. 206) shows at least two-thirds full of hydraulic oil.

(2) Take the hand elevating gears out of mesh by pushing the release lever down and moving the elevating clutch lever away from the gun mount (fig. 213). It may be necessary to rotate the elevating handwheel, slightly, to remove tension from the elevating pinion.

(3) Adjust the gyro control to an approximate vertical position by hand (fig. 217). **CAUTION:** *This operation is necessary to prevent the 76-mm gun from moving sharply into the elevated or depressed position caused by the displacement of the gyro control in other than a vertical position.*

(4) Turn the master turret electrical switch to the "ON" position (216).

TANK, MEDIUM, M4A3

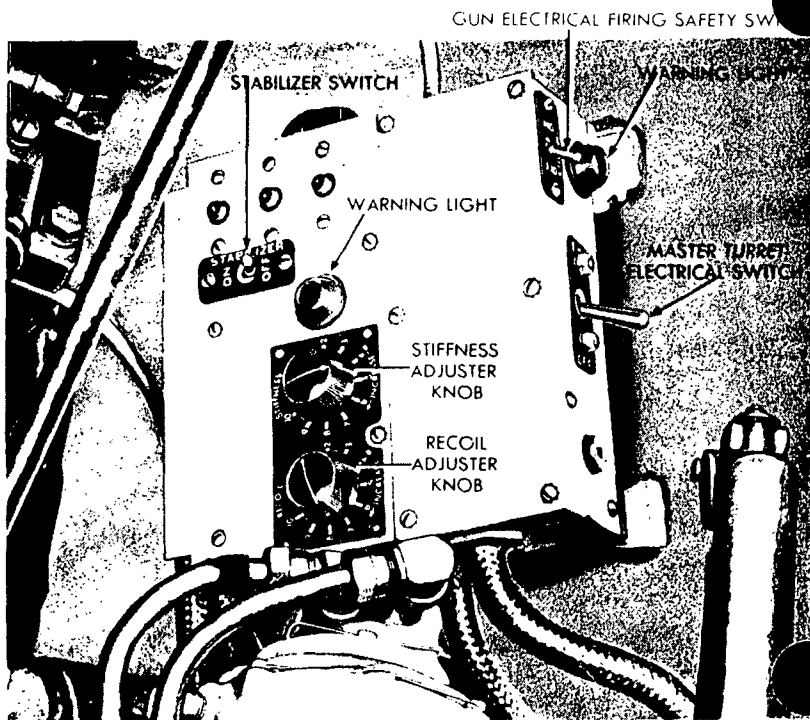

RA PD 77285

Figure 214—Turret Control Box

(5) Turn the stabilizer switch to the "ON" position (fig. 214).

(6) In cold weather, permit the oil to warm up. In subzero weather, allow ½-minute running time for each degree of temperature below zero. For example, a total running time of 10 minutes at 20 degrees below zero.

d. **Adjusting the Stiffness Rheostat.** Starting at zero, slowly turn the knob clockwise (fig. 214). A vigorous vibration of the gun indicates too "stiff" an adjustment. Failure of the gun to remain in its aimed or set position indicates insufficient stiffness. If the gun starts to vibrate after the stiffness control knob is turned, decrease the adjustment by turning the knob in the opposite direction until the vibration is eliminated. It may be necessary to change the stiffness adjustment from time to time as the viscosity of the oil and the tank battery voltage change.

e. **Adjusting the Recoil Rheostat** (fig. 214). The recoil rheostat adjustment prevents the breech from dropping when the gun re-

OPERATING INSTRUCTIONS

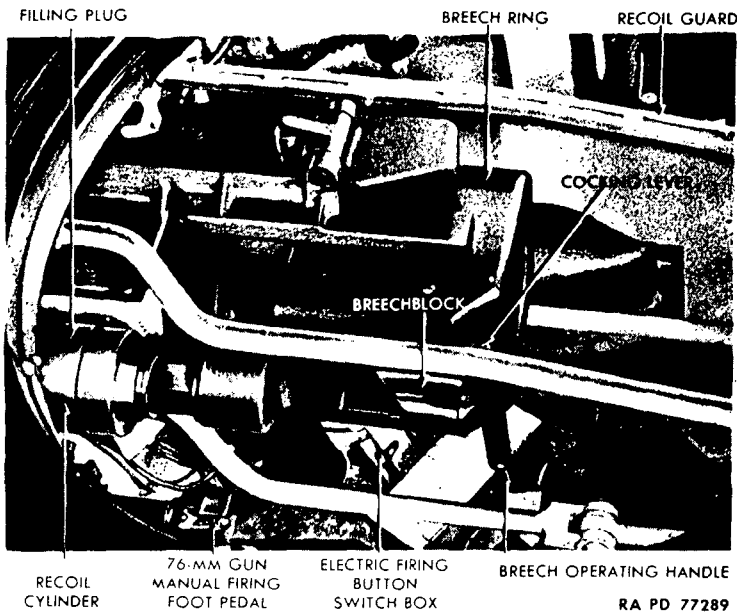

RA PD 77289

Figure 215—Breech End of 76-mm Gun

coils. Make the recoil rheostat adjustment by trial and error while the gun is being fired. Set the recoil adjuster knob on No. 5 position. If the breech of the gun drops during recoil, turn the recoil adjustment knob gradually to the right, or clockwise, until a point is reached where the gun will keep its angular setting during recoil.

f. Checking Stabilizer Operation. Check the stabilizer for effectiveness and accuracy before the tank is used in combat, in the following manner:

(1) Recheck the stiffness rheostat adjustment.

(2) Choose a suitable location for a trial run of the tank. The terrain should be average rough, with no slopes, and sufficient acreage to permit adequate cruising time for the test run.

(3) Operate the tank at a normal and constant speed with the guns aimed at a fixed target.

(4) Observe the target through the telescopic sight in the gunner's periscope or in the direct sighting telescope.

(5) If it is possible to hold the gun on the target within close limits, using the handwheel, the stabilizer is operating satisfactorily.

TANK, MEDIUM, M4A3

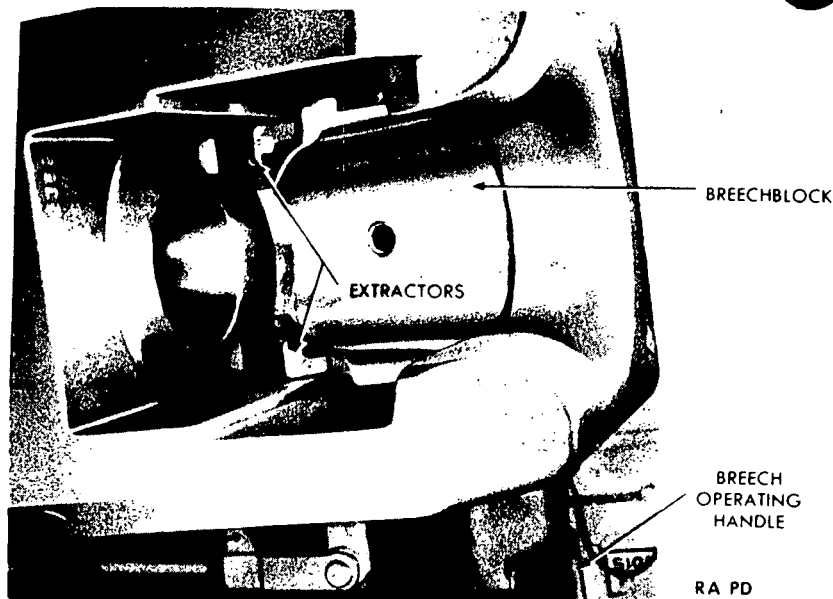

Figure 216—Breech Mechanism on 76-mm Gun

192. OPERATING THE BREECH MECHANISM.

a. **Opening Breech** (figs. 215 and 216). To open the breech, grasp the grip portion of the breech operating handle. Release the latch on the grip, and push the breech operating handle across underneath the breech mechanism and through the opening in the guard. This moves the breechblock to the right and thus opens the breech. *Keep hands out of gun when breech is open.* Return operating handle to the closed position immediately after opening breech in order to avoid injury to personnel and the mechanism.

b. **Closing Breech** (figs. 215 and 216). Close the breech by unlatching the operating handle, pushing it across underneath the breech mechanism and through the body guard. Bear sufficient weight on the handle to overcome the tension of the closing spring. Release the breechblock extractors from their locked position by pressing them forward with the back of an empty cartridge case. The breechblock is then free to be eased into its closed position by means of the operating handle which should finally be latched in place. **CAUTION:** *Never use hands to release the extractors.*

c. **Semiautomatic Operation.** Under ordinary circumstances it will be necessary to open the breech only at the start of firing op-

OPERATING INSTRUCTIONS

ons. A cam attached to the crank arm within the breech mechanism is operated by the recoil of the gun after firing, and serves to open the breech and extract the empty cartridge case during the recoil and return of the gun to battery.

193. LOADING THE GUN.

a. Before loading, open breech and examine the bore of the gun to see that it is clear and free of foreign material. Be sure to return operating handle to its closed position. Refer to paragraphs 203 and 204 for information on authorized ammunition and preparation of ammunition for firing.

b. To load the gun, place a round in the breech, with the nose protruding in the bore, and impel the round into the chamber with sufficient force so that the flange of the cartridge case will drive the extractors forward and automatically close the breech. *NOTE: The loader's hand should be moving toward the left as he shoves the projectile home in order to clear the breechblock as it automatically closes.*

194. FIRING THE GUN.

a. The 76-mm gun can be fired either electrically, or manually in case of failure of the electrical system. A firing switch is located in the turret control box and controls the circuit to the two foot-operated switches convenient to the gunner's foot located on the turret floor. One switch is for the 76-mm gun and the other for the machine gun in the combination gun mount. The foot switches energize the solenoids which fire the 76-mm gun and cal. .30 machine gun. The 76-mm gun may also be fired electrically by the firing trigger on the traverse control handle. The firing pedal is used to fire the 76-mm gun manually.

b. To fire the 76-mm gun electrically, throw the firing switch in the control box to the "ON" position. This will cause the indicating light to glow. Pull the firing safety lever down and rotate one-quarter turn in either direction to hold the lever in the "fire" position. To fire the 76-mm gun, use either the switch on the hydraulic traverse control handle or the 76-mm gun firing switch on the floor of the turret. The cal. .30 machine gun firing switch on the turret floor fires the machine gun when depressed. If the 76-mm gun fails to fire using the firing switches, the firing pedal may be used to fire the gun manually.

c. If the gun fails to fire using either the electrical or manual means, the position of the safety lever should be checked. Failure to fire may be due to the gun staying out of battery, failure of the firing mechanism, failure of the breech to close, or defective ammunition.

TANK, MEDIUM, M4A3



FIRING
SAFETY
LEVER,
76-MM
GUN

GYRO
CONTROL

RA PD
77287

Figure 217—Under Side of 76-mm Gun Mount

If the gun is in battery, recock by means of the cocking lever (fig. 215) located on the top of the breech ring and attempt to fire. **CAUTION:** *In case of a misfire, open the firing switch immediately before recocking.* If the gun still fails to fire after three attempts, wait 30 seconds before opening the breech; then remove round, reload, and attempt to fire again. After need for firing is completed throw the firing switch to the "OFF" position and place safety lever in "safe" position.

195. PLACING THE GUN IN TRAVELING POSITION.

a. Place the safety lever in its "safe" position by rotating the lever one-quarter turn in either direction.

b. Open breech and check that a round of ammunition has not been left in the gun.

SIGHTING AND FIRE CONTROL EQUIPMENT

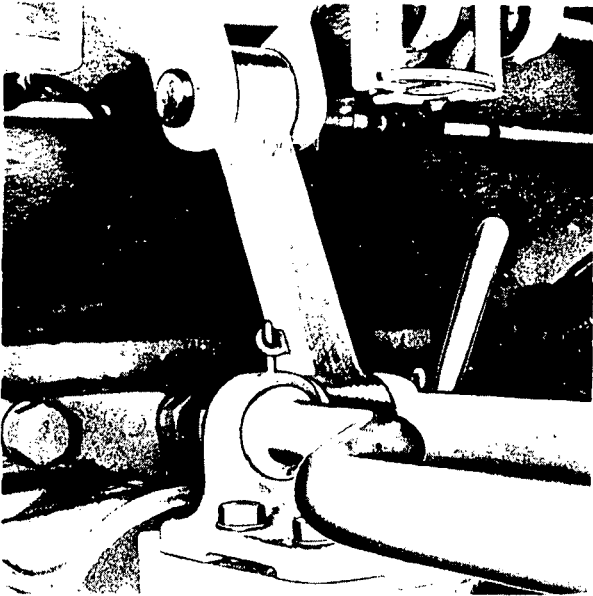

RA PD 19722

Figure 218—Cradle Locked in Traveling Position by Traveling Lock

- c. Clean and lubricate gun and install muzzle cover.
- d. Place the gun in traveling position by taking the traveling lock out of the traveling lock latch and placing the traveling lock in a vertical position (fig. 208). Depress the gun until it bottoms firmly in the traveling lock.
- e. Install pin in cradle traveling lock (fig. 218).
- f. Lock the turret in traveling position by pulling and rotating the turret lock handle one-quarter turn counterclockwise (fig. 212).

Section XXXVII

SIGHTING AND FIRE CONTROL EQUIPMENT

196. CHARACTERISTICS.

- a. The sighting equipment for the 76-mm Gun used in the Medium Tank M4 series includes Telescope Mount M57 with Telescope M71D, illuminated by Instrument Light M33, Periscope M41 with Telescope M47A2 or the Periscope M10G. Elevation

TANK, MEDIUM, M4A3

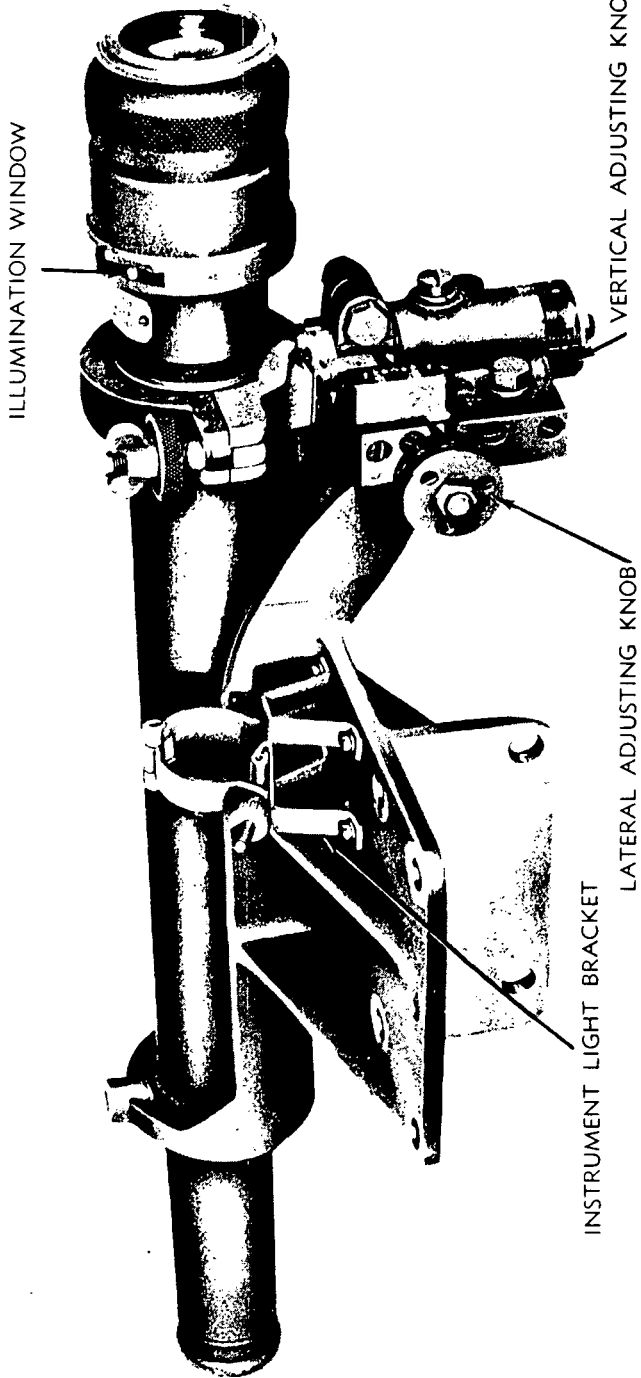

RA PD 84612

Figure 219—Telescope Mounting and Telescope M71D

SIGHTING AND FIRE CONTROL EQUIPMENT

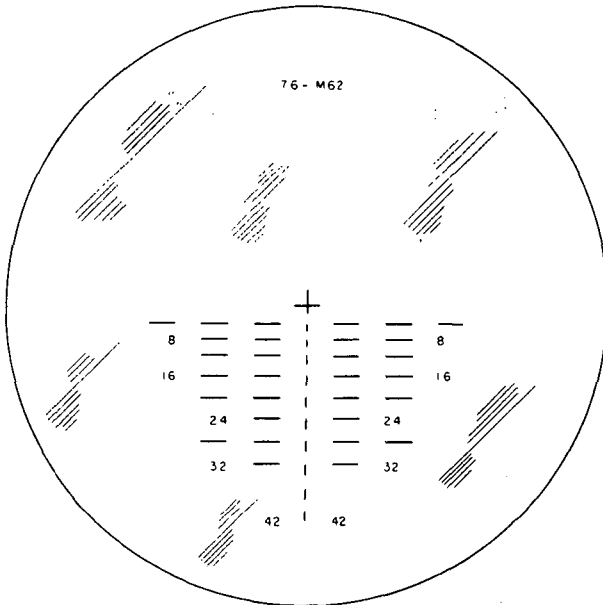

RA PD 84613

Figure 220—Reticle Pattern for Telescope M71D

Quadrant M9 illuminated by Instrument Light M30, and Fuze Setter M14.

197. TELESCOPE MOUNT M57 WITH TELESCOPE M71D.

a. The Telescope Mount M57 (fig. 219) is attached to right-hand side of the gun. The mount has range and deflection adjusting mechanisms for bore sighting the telescope, and an adjustable head-rest, and the Instrument Light M33 for illuminating the reticle of the telescope. The mount supports the Telescope M71D.

b. The Telescope M71D is used for direct fire. The telescope moves with the gun. The reticle pattern (fig. 220) is graduated for Armor-piercing Cap Projectile M62 fired with a muzzle velocity of 2600 feet per second, minus 1.0 mil jump. The graduations are based on data contained in firing table 76-A-4. The cross represents zero deflection for use in lining up the telescope with the gun when bore sighting.

c. To use the Telescope M71D for direct laying of the 76-mm gun, bring the image of the target to the point on the reticle which represents the required range and deflection by rotating the elevating handwheel and traversing the turret. The range markings are in hundreds of yards. Each horizontal line and space represents a

TANK, MEDIUM, M4A3

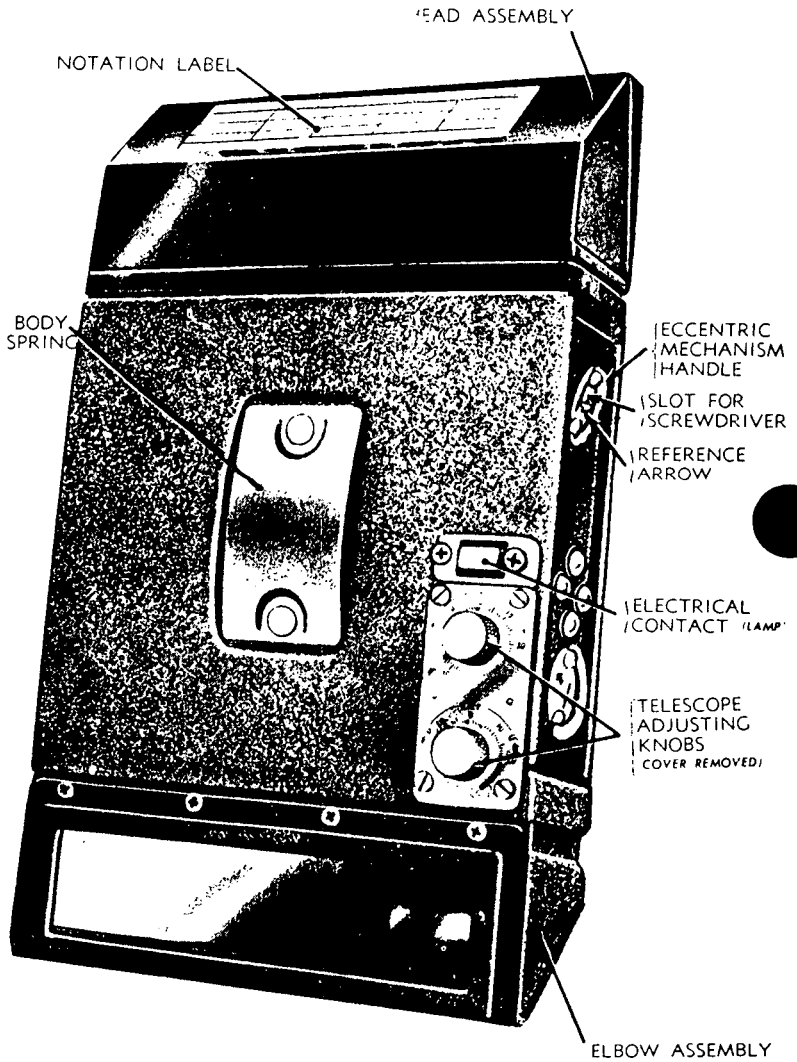

RA PD 6035

Figure 221—Periscope M4A1—Rear View

SIGHTING AND FIRE CONTROL EQUIPMENT

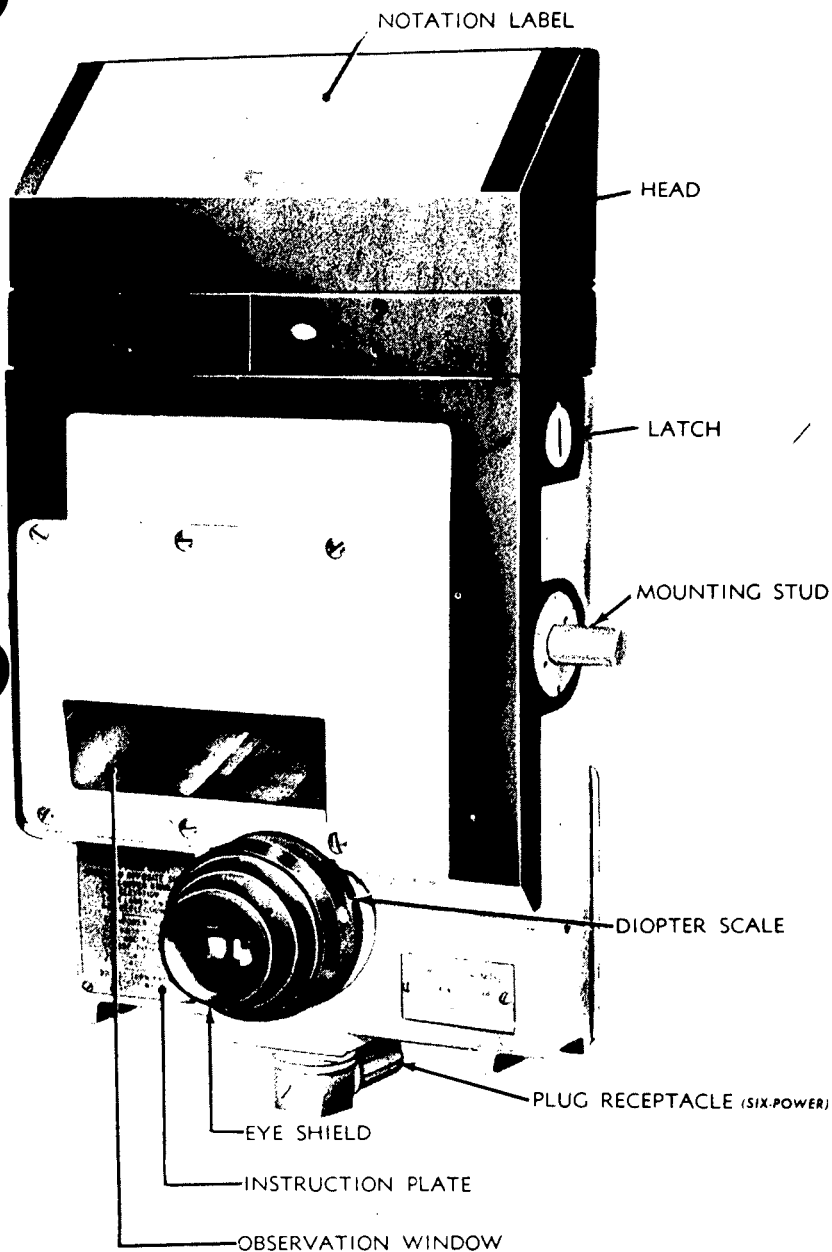

RA PD 31451

Figure 222—Periscope M10G—Right Rear View

TANK, MEDIUM, M4A3

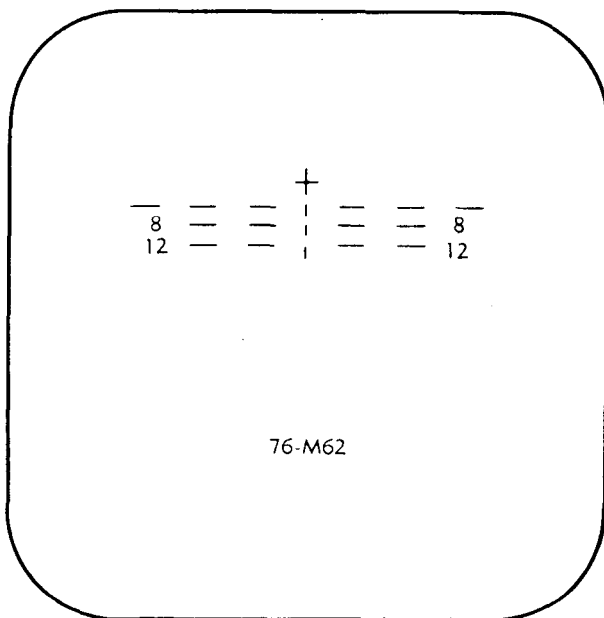

RA PD 6036

Figure 223—Reticle Pattern for One-Power Optical System, Periscope M10G

deflection of 5 mils. The gunner's eye should be approximately 1¼ inches from the telescope eyelens when observing.

198. PERISCOPE M4A1 WITH TELESCOPE M47A2.

a. The Periscope M4A1 contains Telescope M47A2, and is used for direct laying against moving targets when firing the 76-mm Armor-piercing Capped Projectile M62. The head of the periscope (fig. 221) is constructed of plastic material so it will shatter into small pieces if struck by a projectile. The head is readily replaced with the spare heads which are provided.

b. To operate Periscope M4A1 with telescope, observe through the telescope, and bring the image of the target to the point on the reticle representing the required range and deflection, by rotating the elevating handwheel and traversing the turret. By moving the eye to the left of the telescope eyepiece, the periscope may be used for observation. If the periscope is equipped with a window wiper, the window in the head can be cleaned by pulling the periscope down to the retracted position and then pushing it back into the viewing position. Repeat this operation several times until the window is clear.

SIGHTING AND FIRE CONTROL EQUIPMENT

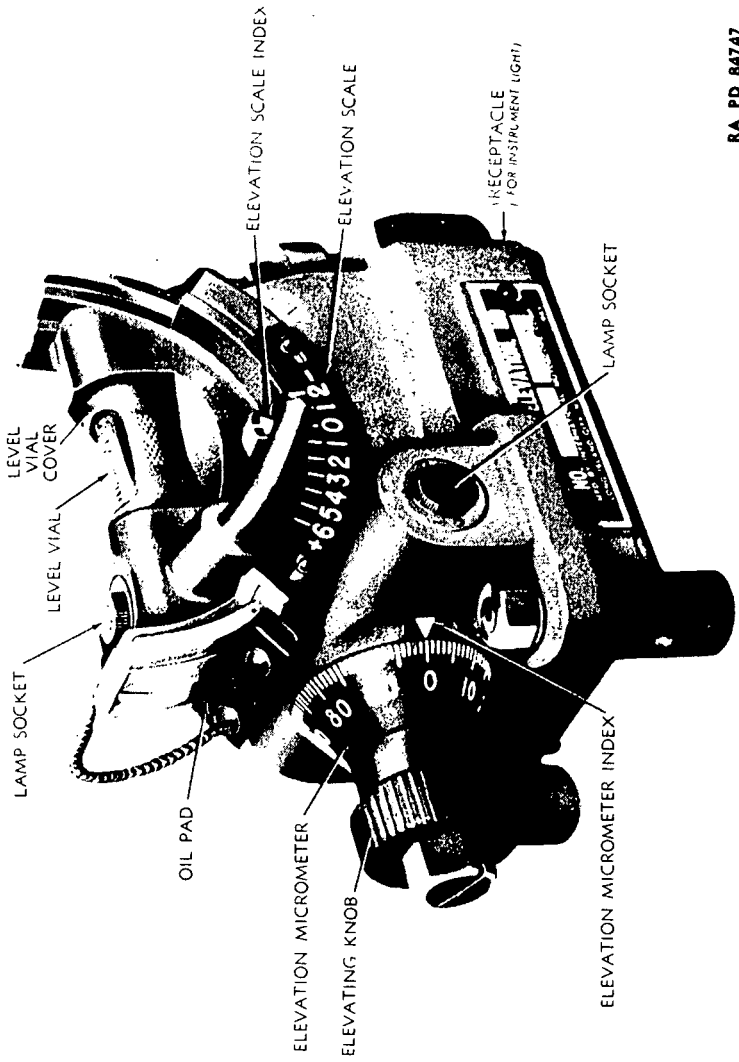

RA PD 84747

Figure 224—Elevation Quadrant M9, Right Side View

TANK, MEDIUM, M4A3



TOP VIEW

FUZE SETTER GRASPED IN HAND

RA PD 70208

Figure 225—Fuze Setter M14

SIGHTING AND FIRE CONTROL EQUIPMENT**199. PERISCOPE M10G.**

a. The Periscope M10G (fig. 222) will eventually replace the Periscope M4A1, as standard equipment. An adapter furnished with the periscope mount permits interchanging of periscopes. The Periscope M10G contains both a one-power and a six-power optical system for direct laying against moving targets. The one-power system is advantageous when the general terrain is to be observed and the target is close to the gun; it may also be used in an emergency to supplant the six-power system. The six-power optical system is used for laying on distant targets. The reticle pattern for the one-power system is shown in figure 223, and the pattern for the six-power system is the same as shown in figure 220. The head of the periscope is constructed of plastic material so it will shatter into small pieces if struck by a projectile. The head is readily replaced with the spare heads which are provided.

b. To operate the Periscope M10G for laying on close targets, observe through the window and bring the image of the target to the point on the reticle representing the required range and deflection, by rotating the elevating handwheel and traversing the turret. For distant targets, observe through the eyepiece. The reticles may be illuminated for night operation.

200. ELEVATION QUADRANT M9.

a. The Elevation Quadrant M9 (fig. 224) is used to lay the 76-mm gun in elevation for indirect fire.

b. To lay the gun in elevation, set off the elevation angle on the coarse scale (100-mil intervals) and on the micrometer (1-mil intervals). The quadrant has two scales and two micrometer indexes. Use the micrometer index on the side corresponding to the scale in use.

201. FUZE SETTER M14.

a. The Fuze Setter M14 (fig. 225) is used as a hand wrench to set the fuzes. After the fuze safety pin has been removed, place the wrench on the fuze with the tapered side of the hole fitting the fuze. Engage the key in the slot of the fuze and turn the handle clockwise (increasing direction) until the index mark on the fuze aligns with the required time setting on the fuze scale. Use care in removing the wrench to avoid changing the setting.

202. BORE SIGHTING.

a. The purpose of bore sighting is to test the alinement of the sighting equipment for parallelism with the gun bore. For expediency it may be performed by sighting on a well-defined fixed object at least 1,000 yards distant.

TANK, MEDIUM, M4A3

b. Open the breech of the gun, and, while looking through the barrel, align the gun on the distant object. With the telescope in position in its mounting, observe through the telescope and note the position of the cross on the reticle representing zero range and zero deflection, with respect to the aiming point. If they do not coincide, move the line of sighting of the telescope, by first loosening the clamping nuts, and then turning the adjusting knobs on the rear of the telescope mount or bracket until coincidence is obtained.

c. Check the Periscope M4A1 or M10G in a similar manner, and if coincidence is not observed, move the line of sighting by, first, removing the cover on the Periscope M4A1 and then turning the adjusting knobs until coincidence is obtained. Press inward on the adjusting knobs of Periscope M10G before turning them. Record the adjustment and serial number of the periscope on the notation label. Replace the cover on the adjusting knobs of the Periscope M4A1.

**Section XXXVIII
AMMUNITION**

203. AUTHORIZED AMMUNITION.

a. Ammunition authorized for the 76-mm gun, M1A1, M1A1A1, and M1A2, is listed in Table I below. Standard nomenclature which completely identifies the ammunition is used in the listing. Identification is provided for by painting and marking on the rounds themselves and on all packing.

TABLE I. AUTHORIZED AMMUNITION¹

Nomenclature	Action of Fuze	Approx. Weight of Projectile, as Fired (lb)
Service Ammunition		
PROJECTILE, fixed, A.P.C., M62A1, w FUZE, B.D., M66A1, and TRACER, 76-mm guns, M1, M1A1, and M1A2	Delay	15.44
PROJECTILE, fixed, A.P.C., M62, w FUZE, B.D., M66A1, and TRACER, 76-mm guns, M1, M1A1, and M1 and M1A2	Delay	15.44
PROJECTILE, fixed, A.P.C., M62, NH w FUZE, B.D., M66A1, and TRACER, 76-mm guns, M1, M1A1, and M1A2	Delay	15.44

(See footnotes at end of Table.)

AMMUNITION

TABLE I. AUTHORIZED AMMUNITION¹—(Contd.)

Nomenclature	Action of Fuze	Approx. Weight of Projectile, as Fired (lb)
Service Ammunition—(Contd.)		
PROJECTILE, fixed, A.P.C., M62, w TRACER, 76-mm guns, M1, M1A1, and M1A2	—	15.11
SHELL, fixed, H.E., M42A1, w FUZE, P.D., M48A1, 76-mm guns, M1, M1A1, and M1A2 ²	SQ & 0.15-sec. delay ³	12.87
SHELL, fixed, H.E., M42A1, w FUZE, P.D., M48A2 SQ & 0.05-sec. delay, 76-mm guns, M1, M1A1, and M1A2 ²	SQ & 0.05-sec. delay ³	12.87
SHELL, fixed, H.E., M42A1, NH, w FUZE, P.D., M48A1, 76-mm guns, M1, M1A1, and M1A2 ²	SQ & 0.15-sec. delay ³	12.87
SHELL, fixed, H.E., M42A1, NH, w FUZE, P.D., M48A2, SQ & 0.05-sec. delay, 76-mm guns, M1, M1A1, and M1A2 ²	SQ & 0.05-sec. delay ³	12.87
SHELL, fixed, H.E., M42A1, w FUZE, P.D., M48, 76-mm guns, M1, M1A1, and M1A2 ²	SQ & 0.05-sec. delay ³	12.87
SHELL, fixed, H.E., M42A1, NH, w FUZE, P.D., M48, 76-mm guns, M1, M1A1, and M1A2 ²	SQ & 0.05-sec. delay ³	12.87
SHELL, fixed, H.E., M42, w FUZE, P.D., M48A1, 76-mm guns, M1, M1A1, and M1A2 ²	SQ & 0.15-sec. delay ³	12.81
SHELL, fixed, H.E., M42A1, reduced charge, w FUZE, P.D., M48A2, SQ & 0.15-sec. delay, 76-mm guns, M1, M1A1, and M1A2 ²	SQ & 0.15-sec. delay ³	12.87
SHELL, fixed, smoke, HC, B.I., M88, 76-mm guns, M1, M1A1, and M1A2	—	7.60
SHOT, fixed, A.P., M79, w TRACER, 76-mm guns, M1, M1A1, and M1A2	—	15.00
Drill (Dummy) Ammunition		
CARTRIDGE, drill, M20, w FUZE, dummy, M59, 76-mm guns, M1 and M1A1	Inert	—

¹See footnotes at end of Table.)

TANK, MEDIUM, M4A3

A.P.—armor-piercing	B.I.—base-ignition
A.P.C.—armor-piercing-capped	H.E.—high-explosive
B.D.—base-detonating	P.D.—point-detonating

SQ—superquick

- 1—(a) Service rounds which do not have "NH" in the nomenclature contain flashless (FNH) propellant powder.
- (b) Service rounds for the 76-mm gun have been manufactured with both brass and steel cases. Nomenclature of steel-case rounds includes the words "steel case" immediately following the model designation. The words are also stenciled on packing boxes and crates, when applicable. Steel cartridge cases are signified in the stamping on the base of the case by the addition of the suffix "B" and arabic numeral to the model designation of the case. The ammunition lot number has an "X" suffix when the round is steel cased.
- 2—In future manufacture, 76-mm rounds requiring the M48 series fuze, other than reduced charge rounds, will be fuzed with the M48, or the M48A2 with 0.05-second delay. Reduced-charge rounds will be fuzed with the M48A1 or M48A2 fuzes with 0.15-second delay.
- 3—The delay of FUZE, P.D., M48 is 0.05 second; of FUZE, P.D., M48A1, 0.15 second. The M48A2 fuze may have either 0.05 second or 0.15 second delay, depending on the lot. Provision is made for identification by stamping the length of delay in seconds on the fuze, immediately following the model number. Thus, M48A2 fuzes with the 0.05 second delay element will have stamped on the body, "FUZE, P.D., M48A2 (.05 SEC.)"

204. PREPARATION FOR FIRING.

a. The 76-mm rounds are ready for firing as removed from packing, except for setting the M48 point-detonating fuzes of the high-explosive rounds for the required action. As shipped, FUZE, P.D., M48, FUZE, P.D., M48A1, and FUZE, P.D., M48A2, are set for superquick action (SQ), that is, the slot in the setting screw is parallel to the axis of the fuze and in line with "SQ." To adjust for delay action, the setting screw should be turned by means of the screwdriver end of WRENCH, fuze, M7A1, or similar instrument, so that the slot is alined with "DELAY," that is, at right angles to the axis of the fuze. (Delay action is provided for in the fuze by a delay pellet.) The setting may be made or changed at will, and can be done in the dark by noting the position of the slot in the setting sleeve.

PART FOUR—AUXILIARY EQUIPMENT—(Contd.)

D—ARMAMENT

105-MM HOWITZER M4 IN THE COMBINATION GUN MOUNT M52

Section XXXIX

INTRODUCTION

205. SCOPE.

a. Part Four-D contains instructions for the operation of the 105-mm Howitzer M4 in the Combination Gun Mount M52. It

INTRODUCTION

RA PD 19706



Figure 226—Medium Tank M4 Series Guns Installed

TANK, MEDIUM, M4A3

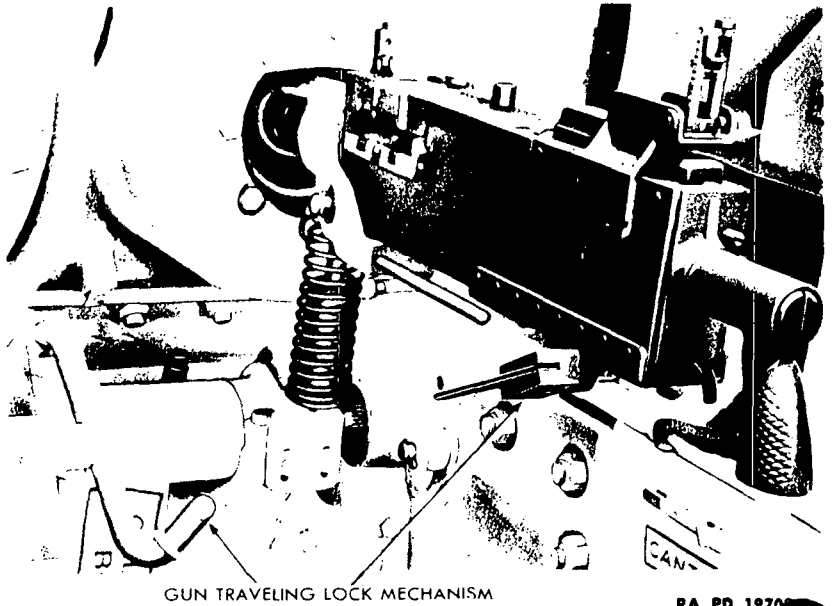

Figure 227—Cal. .30 M1919A4 Machine Gun Installed in Mount

the authorized ammunition for the howitzer and contains information on the sighting equipment. Refer to section IX for lubrication instructions on the armament.

b. The other armament in the vehicle (fig. 226) is as follows: Cal. .30, M1919A4 Machine Gun mounted in the Combination Gun Mount M52; Cal. .30, M1919A4 Machine Gun mounted in a bow mount in the right front side of the vehicle (fig. 227); Cal. .50 HB, M2 Machine Gun mounted in a bracket-type mount on a revolving turret hatch (fig. 228); and a 2-inch Mortar M3 located in a fixed mount in the turret to the left of the combination gun mount (fig. 229).

206. CHARACTERISTICS.

a. The armament is employed chiefly against enemy tanks and other ground objectives. The turret can be traversed 360 degrees manually. The 105-mm howitzer can be elevated 35 degrees and depressed 10 degrees. The cal. .30 machine gun in the combination gun mount is elevated and traversed with the howitzer.

b. The cal. .30 machine gun in the bow mount is elevated and traversed manually and fired by the conventional trigger. Refer to FM 23-50 for complete information on its operation.

INTRODUCTION

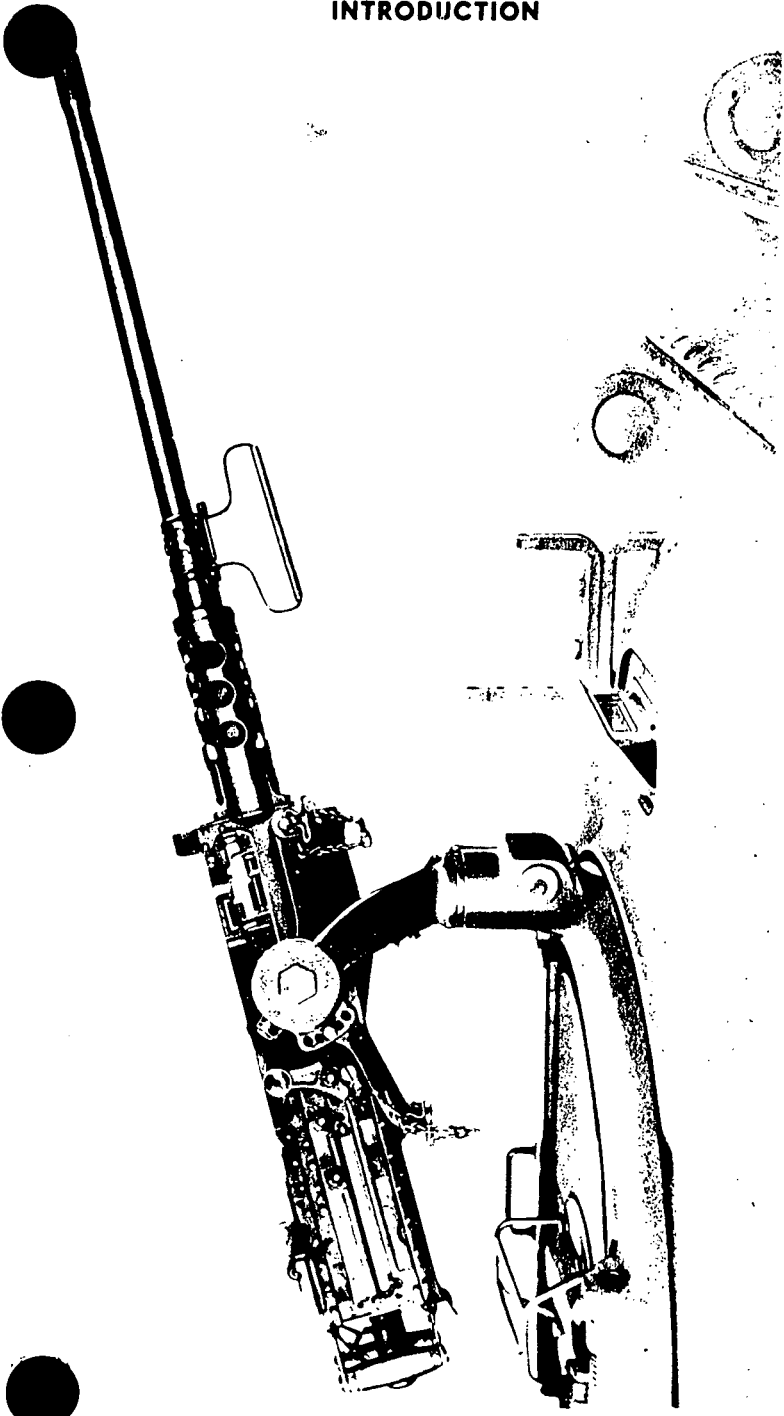

RA PD 19708

Figure 228—Cal. .50 HB, M2 Antiaircraft Gun Installed

TANK, MEDIUM, M4A3

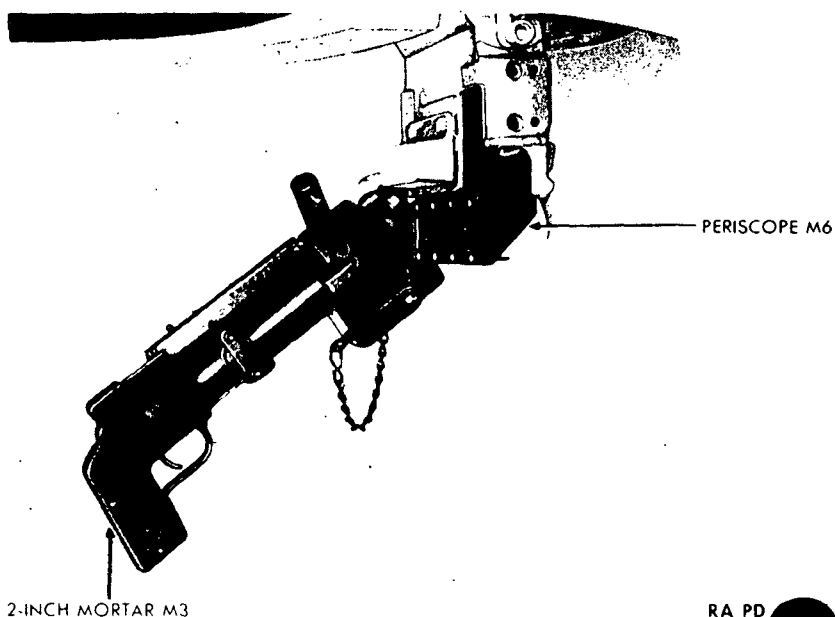

Figure 229—2-inch Mortar M3 Installed

c. The cal. .50 machine gun is employed chiefly against enemy aircraft, and is elevated and traversed manually and fired by the conventional trigger. The machine gun can be traversed independently of the turret. Refer to FM 23-65 for complete information on its operation.

d. The 2-inch mortar is used to lay a smoke screen while the tank is advancing. It is mounted in a fixed mount, has no elevation or depression, and traverses with the turret. Refer to TM 9-293 for complete information on its operation.

Section XL

OPERATING INSTRUCTIONS

207. PLACING THE 105-MM HOWITZER IN FIRING POSITION.

- a. Remove the muzzle cover.
- b. Pull out the traveling lock pin from the cradle lock, and the traveling lock bar in position under turret roof (fig. 230).

OPERATING INSTRUCTIONS

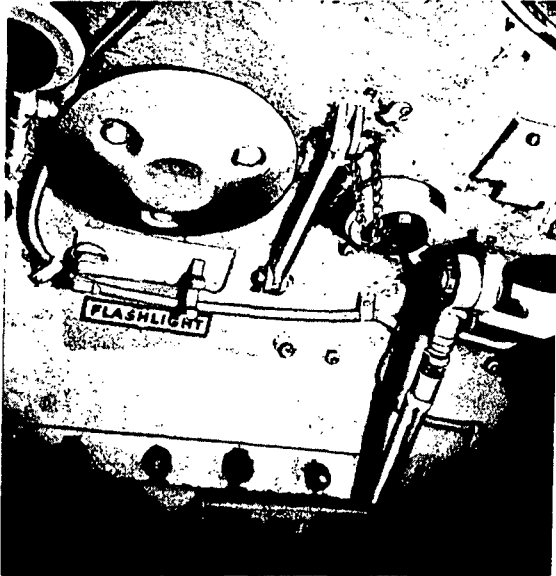

RA PD 85144

Figure 230—Cradle Lock Disengaged

c. To disengage the howitzer traveling lock, pull down on the spring release, and elevate the howitzer until it clears the lock. Swing the traveling lock down to its latched position and it will be locked in place by the traveling lock latch (fig. 231).

d. Disengage the turret lock by turning the handle, pulling it out, and rotating one-quarter turn clockwise (fig. 233).

208. INSPECTION BEFORE FIRING.

a. **Check Oil Level in Recoil Cylinder.** To check oil level, depress howitzer 5 degrees and remove the filling plugs (figs. 232 and 234) at the rear of each recoil cylinder. The oil level in the cylinder should reach the bottom of the hole. If oil level does not reach this level, fill until level is reached. Replace plugs. The recoil mechanism uses special recoil oil for all temperatures.

b. Check path of recoil to make sure that it is free from all obstructions.

c. Open breech and inspect bore of gun for cleanliness.

d. **Bore Sighting.** Refer to paragraph 219.

OPERATING INSTRUCTIONS

RA PD 19705

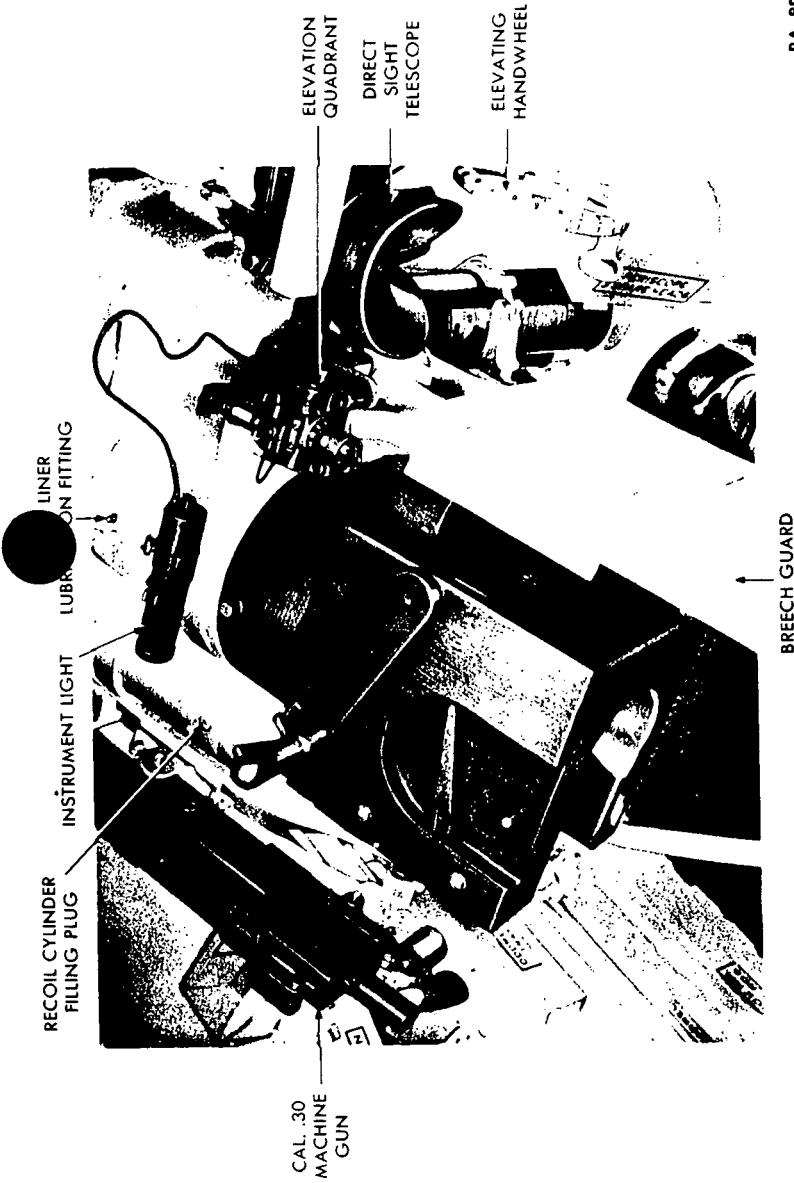
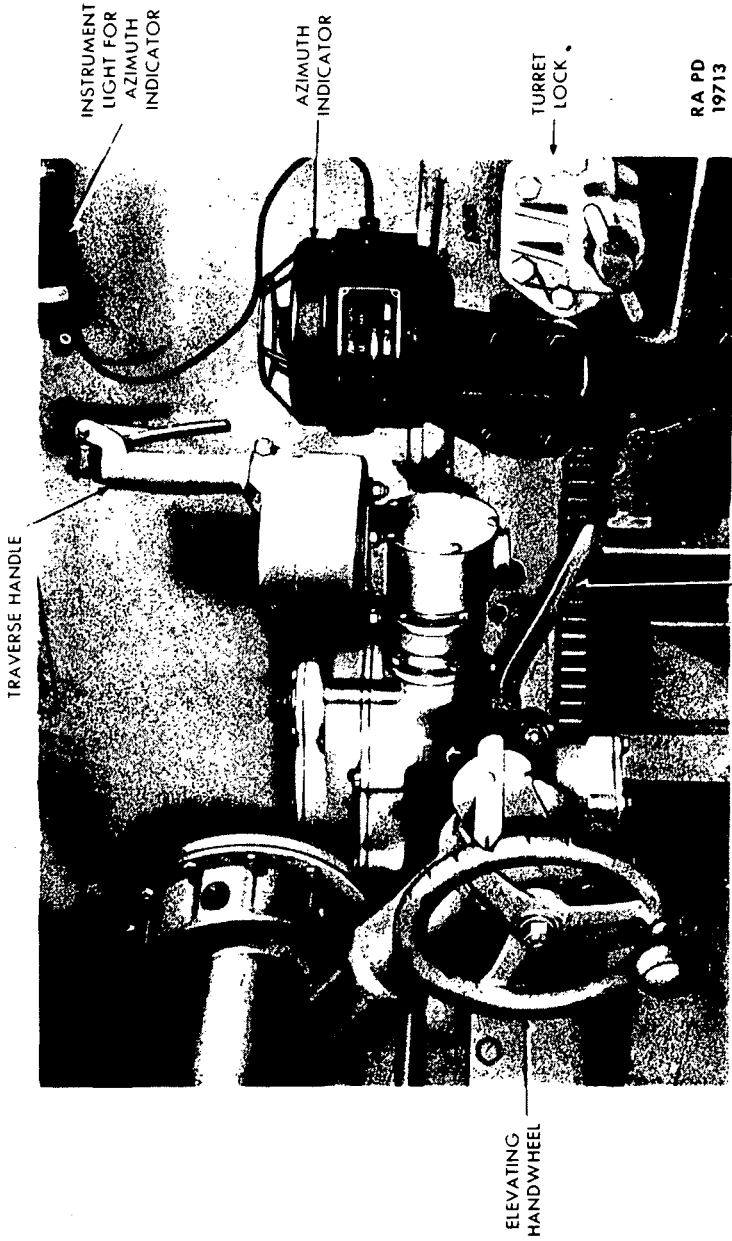

Figure 232—Installation of Guns and Sighting Equipment in Turret

TANK, MEDIUM, M4A3



RA PD
19713

Figure 233—Elevating and Traversing Mechanisms

OPERATING INSTRUCTIONS

RECOIL CYLINDER
FILLING PLUG

BREECHBLOCK
OPERATING HANDLE

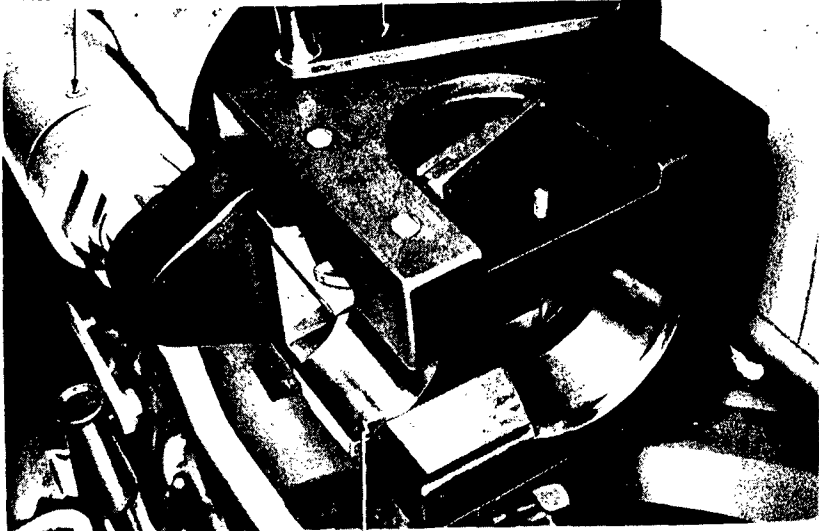

BREECHBLOCK

RA PD 19714

Figure 234—Breechblock in Closed Position

209. TRAVERSING TURRET.

a. To traverse turret the shift lever (fig. 233) must be pulled down as far as it will go. Disengage turret lock. Before traversing turret make sure hatches for driver and assistant driver are closed, and personnel are clear of rotating parts. Grip manual traverse control handle and its associate lever on top of gear mechanism to release brake in gear box. Turn handle clockwise to rotate turret clockwise, and to left or counterclockwise to rotate turret counterclockwise.

b. An azimuth indicator (fig. 233) is mounted to the right of the traverse handle and gives position of the howitzer in traverse.

210. ELEVATING OR DEPRESSING HOWITZER.

a. Elevating handwheel (fig. 233) is located left of traversing mechanism. A clockwise rotation of handwheel will elevate howitzer. The handwheel is notched in 25 equal divisions. Each notch on handwheel represents one mil elevation or depression of howitzer. Maximum elevation is 35 degrees and maximum depression is 10 degrees.

b. An elevation quadrant is located on the top of the cradle (fig. 232) and gives position of the gun in elevation or depression.

TANK, MEDIUM, M4A3

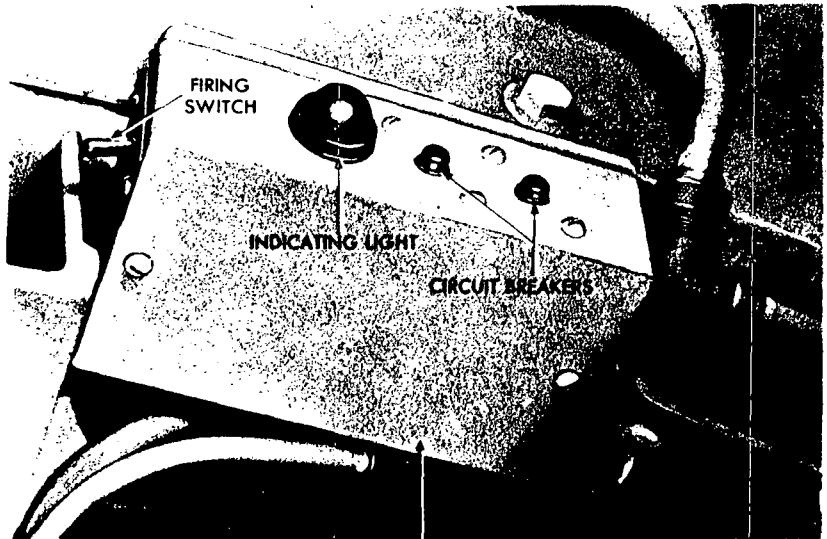

FIRING SWITCH BOX

RA PD 19710

Figure 235—Firing Switch Box Installed

211. OPERATING BREECH MECHANISM.

a. Grasp the breechblock operating handle and squeeze the handle latch until the latch is disengaged from the operating latch catch. Pull the breechblock operating handle (fig. 234) to the rear and right as far as it will go. *NOTE: This breechblock is manually operated, and has no semiautomatic feature.*

b. To close the breech, move the breechblock operating handle forward until the operating handle latch locks in its closed position in the catch on the top of the breech ring.

212. LOADING THE HOWITZER.

a. To load the howitzer, push the round into the breech recess (fig. 234). As the lip on the cartridge case contacts the extractor, it imparts a slight motion to the breechblock operating handle. When this motion is felt, close the breech. *CAUTION: Make sure that the operating handle latch locks in its closed position on the catch on the top of the breech ring.*

213. FIRING THE HOWITZER.

a. The 105-mm howitzer can be fired electrically, or manually in case of failure of electrical system. A firing switch box (fig.

OPERATING INSTRUCTIONS

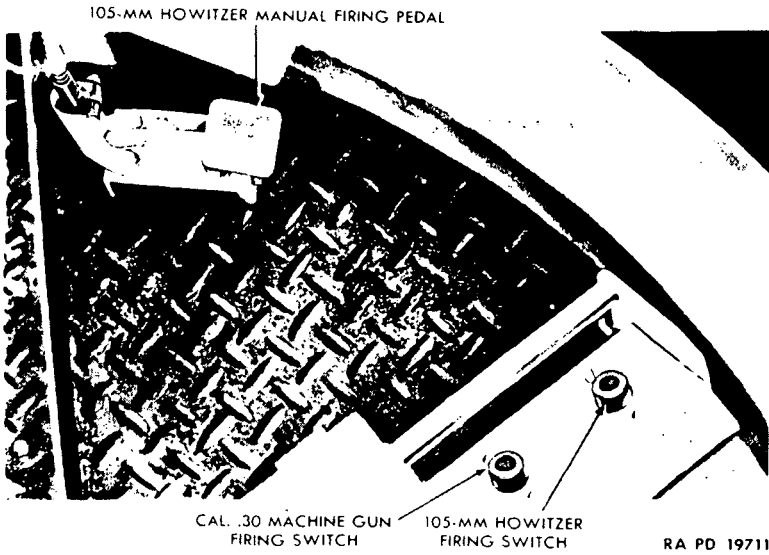

Figure 236—Turret Guns, Firing Switches, and Manual Firing Pedal

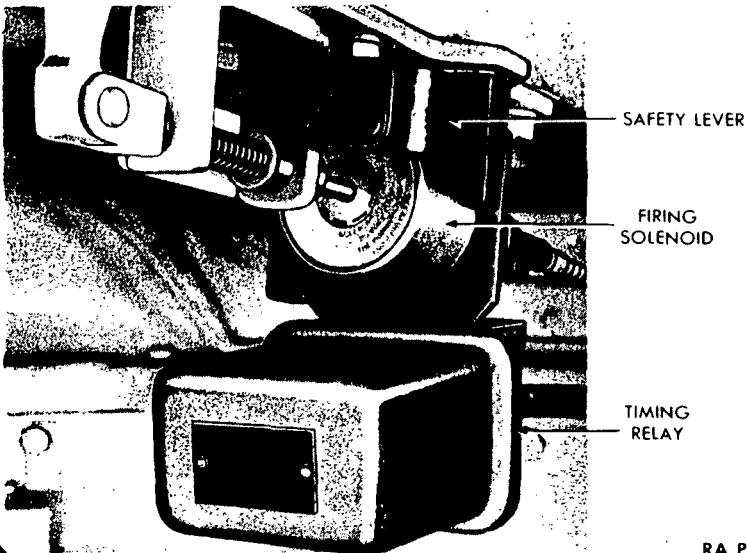
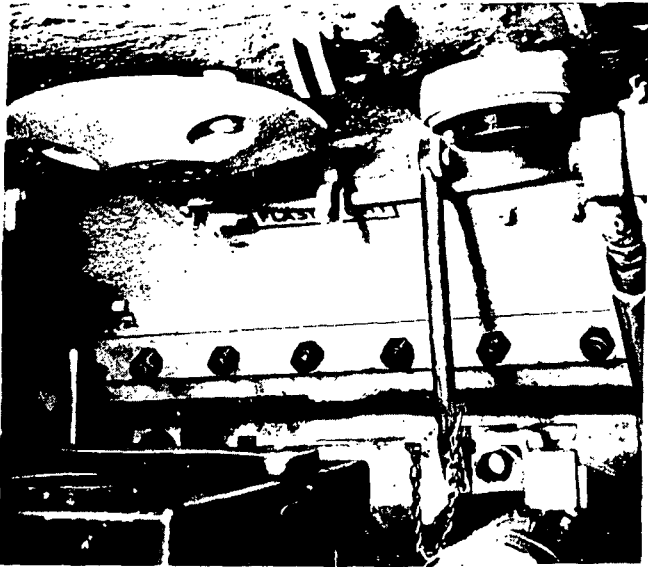

Figure 237—105-mm Howitzer Firing Mechanism

TANK, MEDIUM, M4A3



RA PD 85143

Figure 238—Cradle Lock in Traveling Position

is installed to the right of the turret lock which controls the circuit to the two foot-operated switches convenient to the gunner's foot (fig. 236) located on the turret floor. One switch is for the howitzer and the other for the machine gun in the combination gun mount. The foot-operated switches energize the solenoids which fire the howitzer and cal. .30 machine gun. A firing pedal is used to fire the 105-mm howitzer manually.

b. To fire the howitzer electrically, throw the firing switch to the "ON" position. This will cause the indicating light to glow. Pull the safety lever (fig. 237) all the way out. This disengages it from the firing mechanism plunger. Depress the 105-mm howitzer firing switch (fig. 236) located on the turret floor to fire the gun. The cal. .30 machine gun firing switch fires the machine gun when depressed. To fire the howitzer manually, depress the manual firing pedal located in the turret floor.

c. If the howitzer fails to fire using either the electrical or manual means, the position of the safety lever should be checked. Failure to fire may be due to the howitzer staying out of battery, failure of the firing mechanism, failure of the breech to close, or defective ammunition. If the howitzer is in battery, recock by means of the cocking lever located on the top of the breech ring and attempt to fire. CAUTION

SIGHTING AND FIRE CONTROL EQUIPMENT

In case of a misfire open the firing switch immediately before recocking. If the howitzer still fails to fire after three attempts, wait 30 seconds before opening the breech; then remove round, reload, and attempt to fire again. After need for firing is completed, throw the firing switch to the "OFF" position.

214. PLACING HOWITZER IN TRAVELING POSITION.

- a. Push the safety lever (fig. 237) all the way in to its "safe" position. This prevents the howitzer from being fired accidentally.
- b. Open breech and check that a round of ammunition has not been left in the howitzer.
- c. Clean and lubricate howitzer and install muzzle cover.
- d. Place the howitzer in traveling position by taking the traveling lock out of the traveling lock latch and placing the traveling lock in a vertical position (fig. 231). Depress the howitzer until it bottoms firmly in the traveling lock.
- e. Install pin in cradle traveling lock (fig. 238).
- f. Lock the turret in traveling position by pulling and rotating the turret lock handle one-quarter turn counterclockwise (fig. 233).

Section XLI**SIGHTING AND FIRE CONTROL EQUIPMENT****215. CHARACTERISTICS.**

a. The sighting equipment for the 105-mm Howitzer used in the Medium Tank M4 series includes Telescope Mount M56 with Telescope M72D illuminated by Instrument Light M33, Periscope M4A1 with Telescope M77C or the Periscope M10D, Elevation Quadrant M9 illuminated by Instrument Light M30, and Fuze Setter M23.

216. TELESCOPE MOUNT M56 WITH TELESCOPE M72D.

a. The Telescope Mount M56 (fig. 240) which supports the Telescope M72D is mounted on the right side of the 105-mm Howitzer. The mount and telescope are similar to and are operated in the same manner as the Telescope Mount M57 with its telescope described in paragraph 197.

TANK, MEDIUM, M4A3

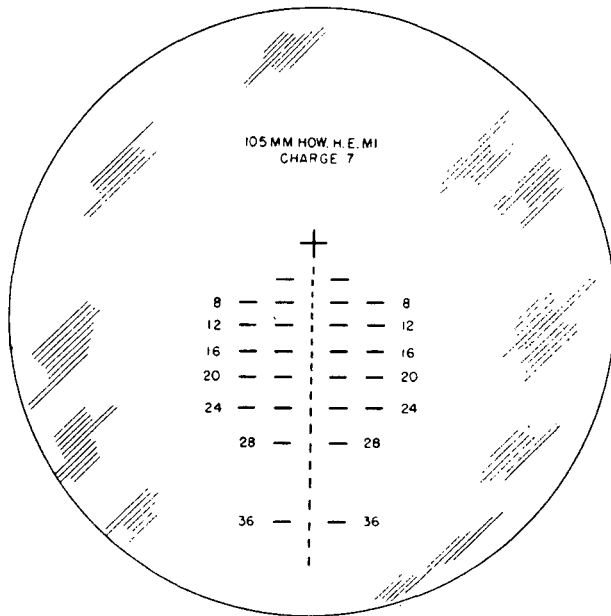

RA PD 84779

Figure 239—Reticle Pattern for Telescope M72D

b. The reticle pattern (fig. 239) is graduated for High Explosive Shell M1, fired with a muzzle velocity of 1550 feet per second; charge 7; plus 0.2 mil jump. The graduations are based on data contained in firing table 105-H-3, part 2G. The cross represents zero range and zero deflection for use in bore sighting the telescope.

217. PERISCOPE M4A1 WITH TELESCOPE M77C AND PERISCOPE M10D.

a. These periscopes which are used on the 105-mm howitzer, are identical to, and are operated in the same manner as the periscopes described in paragraphs 198 and 199.

218. FUZE SETTER M23.

a. The Fuze Setter M23 which is a hand-operated dialed instrument is used for setting the mechanical time fuzes. The Fuze Setter M14 is also furnished for this purpose.

b. To cut a fuze, rotate the corrector knob on the fuze setter until the announced corrector valve is registered. Rotate the time setting knob until the announced time valve is registered. Re

AMMUNITION

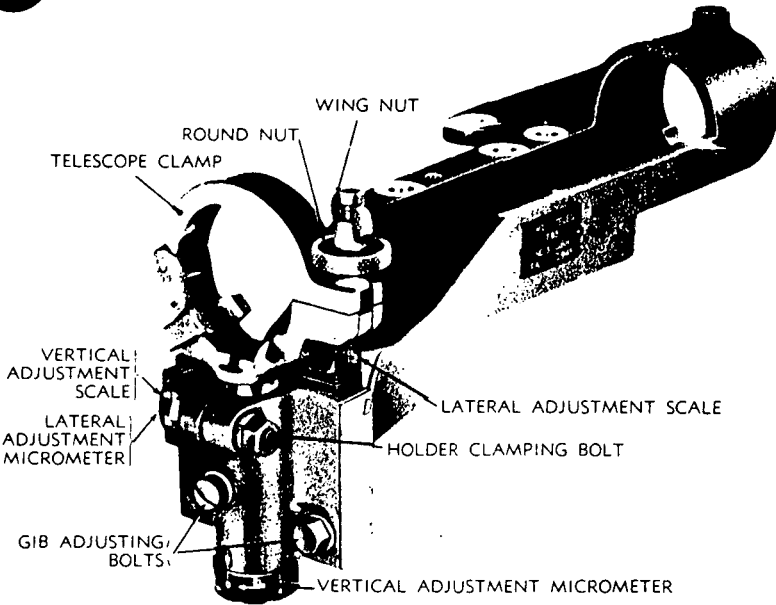

RA PD 29173

Figure 240—Telescope Mount M56—Right Side

the safety wire from the fuze, and place the fuze setter carefully over the fuze. Turn the fuze setter clockwise with the hand until the notch in the fuze engages the stop in the fuze setter. Push the instrument down to fully engage the stop and continue to turn the fuze setter in the same direction until the pawl in the adjusting ring drops into the notch in the fixed fuze ring, indicating that the setting operation is completed. Without rotating the fuze setter, lift it off the fuze.

c. A fuze which has been set can be reset to the **SAFE** position by setting the fuze setter time scale to "S", the corrector scale to normal (30), and resetting the fuze as described above.

219. ELEVATION QUADRANT M9 AND BORE SIGHTING.

a. The Elevation Quadrant M9 is described in paragraph 200 and the Bore Sighting is described in paragraph 202.

Section XLII
AMMUNITION

220. AUTHORIZED AMMUNITION.

Ammunition authorized for the 105-mm howitzer, M4, is listed in Table I. Standard nomenclature which completely identifies

TANK, MEDIUM, M4A3

the ammunition is used in the listing. Identification is provided on the round itself by painting and marking in accordance with the basic scheme prescribed in TM 9-1900, and on all packing.

TABLE I. AUTHORIZED AMMUNITION¹

Nomenclature	Action of Fuze	Approx. Weight of Projectile, as Fired (lb)
Service Ammunition		
SHELL, semifixed, H.E., A.T., M67, w/ FUZE, B.D., M62 or M62A1, 105-mm how., M2, M2A1, and M4 ²	Nondelay	28.79
SHELL, semifixed, H.E., M1, w FUZE, P.D., M48, 105-mm how., M2, M2A1, and M4 ^{3 4}	SQ & 0.05-sec. delay ⁵	33.00
SHELL, semifixed, H.E., M1, w FUZE, P.D., M48A1, 105-mm how., M2, M2A1, and M4 ^{3 4}	SQ & 0.15-sec. delay ⁵	33.00
SHELL, semifixed, H.E., M1, w FUZE, P.D., M48A2, SQ & 0.15-sec. delay, 105-mm how., M2, M2A1, and M4 ^{3 4}	SQ & 0.15-sec. delay ⁵	33.00
SHELL, semifixed, H.E., M1, w FUZE, TSQ, M54, 105-mm how., M2, M2A1, and M4 ³	Time to 25 sec., & SQ	32.98
SHELL, semifixed, smoke, HC, B.E., M84, w FUZE, P.D., M54, 105-mm how., M2, M2A1, and M4 ³	Time to 25 sec., & SQ	32.87
SHELL, semifixed, smoke, FS, M60, w/ FUZE, P.D., M57, 105-mm how., M2, M2A1, and M4 ³	SQ	35.21
SHELL, semifixed, smoke, phosphorus, WP, M60, w FUZE, P.D., M57, 105-mm how., M2, M2A1, and M4 ³	SQ	34.70
SHELL, semifixed, gas, persistent, H, M60, w FUZE, P.D., M57, 105-mm how., M2, M2A1, and M4 ³	SQ	33.77
SHELL, semifixed, gas, persistent, CNS, M60, w/ FUZE, P.D., M57, 105-mm how., M2, M2A1, and M4 ³	SQ	

(See footnotes at end of Table.)

AMMUNITION

TABLE I. AUTHORIZED AMMUNITION¹ — (Contd.)

Nomenclature	Action of Fuze	Approx. Weight of Projectile, as Fired (lb.)
Practice Ammunition		
SHELL, semifixed, empty; for sand loading, M1, w FUZE, inert, P.D., M48, 105-mm how., M2, M2A1, and M4 ²	Inert	33.00
Blank Ammunition		
AMMUNITION, blank (1.5-lb or 2-lb charge), 105-mm how., M2, M2A1, M3 and M4	—	—
Drill (Dummy) Ammunition		
CARTRIDGE, drill, semifixed, M14, w/FUZE, dummy, M59, 105-mm how., M2, M2A1, M3, and M4 ³	Inert	—

B.D.—base-detonating
 B.E.—base-ejection
 H.E.—high-explosive

H.E., A.T.—high-explosive antitank
 P.D.—point-detonating
 SQ—superquick

- 1—(a) Service and practice rounds have been manufactured with both brass and steel cases. Nomenclature of steel case rounds includes the words "steel case" immediately following the model designation. The words are also stenciled on packing boxes and crates, when applicable. Steel cartridge cases are signified in the stamping on the base of the case by the addition of "B1" to the model designation of the case. The ammunition lot number has an "X" suffix when the round is steel cased.
- (b) With the exception of the canister round, which is the same for all 105-mm howitzers, rounds for the M2, M2A1, and M4 howitzers differ from those for the M3 (airborne) howitzer only with respect to propelling charges. The adjustable charges of rounds for the M2, M2A1, and M4 howitzers are made up of seven sections, whereas the M3 howitzer rounds have a five-section charge of quick-burning powder. These charges, or sections thereof, are not interchangeable. However, the M1 high-explosive rounds for the M3 howitzer may be fired in the M2, M2A1, and M4 howitzers by applying suitable corrections as given in FT 105-H-3 and changes.
- 2—The propelling charges of these rounds are nonadjustable, and are retained in a single cloth bag fastened in the bottom end of the cartridge case.
- 3—The propelling charges of these rounds are adjustable, and are in seven parts. Each part is held in a separate cloth bag. All sections are loosely linked together to permit withdrawal of unnecessary increments in the field.
- 4—In future manufacture of 105-mm howitzer rounds, high-explosive rounds requiring the M48-type fuze will be fuzed with the M48A1, or M48A2 with 0.15-second delay.
- 5—The delay of FUZE, P.D., M48 is 0.05 second; of FUZE, P. D., M48A1, 0.15 second. The M48A2 fuze may have either 0.05 second or 0.15 second delay, depending on the lot. Provision is made for identification by stamping the

TANK, MEDIUM, M4A3

length of delay in seconds on the fuze, immediately following the model number. Thus, M48A2 fuzes with the 0.15 second delay element will have stamped on the body, "FUZE, P.D., M48A2 (.15 SEC.)".

6—This cartridge has an inert sectioned charge simulating the adjustable sectioned service propelling charge.

221. PREPARATION FOR FIRING.

a. H.E.A.T. rounds, which have fixed (nonadjustable) propelling charges, are ready for firing once the packing is removed and the projectile is seated properly in the cartridge case.

b. Rounds with semifixed (adjustable) propelling charges require the following preparation before firing:

(1) After removing the round from its packing, withdraw the U-shaped packing stop from the fuze wrench slots in the fuze. This stop is used to prevent the fuze from touching the separator or end of the fiber container. Serious damage may result if this stop is not removed before firing.

(2) Adjust the propelling charge for the zone to be fired. When the full (outer zone) charge is to be fired, no adjustment is necessary, but the charge should be inspected to make certain that all proper sections are present. For inner zones, withdraw the increments from the cartridge case, and remove and discard those increments numbered higher than the charge to be fired, by cutting or breaking the twine between the designated charge and the higher numbered increments. Reassemble the remaining increments in the cartridge case in their proper numerical order with the number of each increment uppermost. Thus, when adjusting the propelling charge to fire charge 4, increments 5, 6 and 7 will be removed and the remaining parts to and including 4 will be reassembled in the cartridge case.

(3) Upon completion of the above preparation, rounds fuzed with the M57 fuze are ready for firing, since this is a single action fuze requiring no special preparation. In the case of rounds with the M48-series or M54 fuzes, the fuze must be set for the required action, as described in the following paragraphs.

(4) FUZE, P.D., M48, M48A1, and M48A2.—As shipped, these fuzes are set for superquick action (SQ), that is, the slot in the setting screw is parallel to the axis of the fuze and in line with "SQ." To adjust for delay action, the setting screw should be turned by means of the screwdriver end of WRENCH, fuze, M7A1, or similar instrument, so that the slot is alined with "DELAY," that is, at right angles to the axis of the fuze. (Delay action is provided for in the fuze by a delay pellet.) The setting may be made or changed at will, and can be done in the dark by noting the position of the slot in the setting sleeve.

AMMUNITION

(5) FUZE, P.D., M54.—Prior to firing, with either superquick or time setting, the safety pull wire securing the time plunger during shipment must be withdrawn from the fuze (pull lower end of wire from the hole and slide wire off end of fuze). To obtain superquick action, the fuze may be left at the safe (S) setting, as shipped, or may be set for a time longer than the expected time of flight. Since the superquick action is always operative, it will function on impact unless prior functioning has been caused by time action. If time action is required, the graduated time-ring (graduated to 25 seconds) is set for the required time of burning by means of a fuze setter. **NOTE:** *If, after setting the fuze preparatory to firing, the round is not fired, the fuze should be reset "safe" and the safety pull wire replaced in its proper position before returning the round to its packing.*

TANK, MEDIUM, M4A3**APPENDIX****Section XLIII****SHIPMENT AND LIMITED STORAGE****222. GENERAL INSTRUCTIONS.**

a. Preparation for domestic shipment of the vehicle is the same as preparation for limited storage. Preparation for shipment by rail includes instructions for loading the vehicles, blocking necessary to secure the vehicles on freight cars, clearance, weight, and other information necessary properly to prepare the vehicle for domestic rail shipment. For more definite information and for preparation of the vehicles for indefinite storage refer to AR 850-18.

223. PREPARATION FOR LIMITED STORAGE.

a. Vehicles to be prepared for limited storage are those ready for immediate service, but not used for less than 30 days. If vehicles are to be indefinitely stored after shipment by rail, they should be prepared for such storage at their destination.

b. If the vehicles are to be placed in limited storage, take the following precautions.

(1) **LUBRICATION.** Lubricate the vehicle completely (par 29).

(2) **COOLING SYSTEM.** If freezing temperature may normally be expected during the limited storage or shipment period, test the coolant with a hydrometer and add the proper quantity of antifreeze to afford protection from freezing at the lowest temperature anticipated during the storage or shipping period. Completely inspect the cooling system for leaks.

(3) **BATTERY.** Check battery and terminals for corrosion, and if necessary, clean and thoroughly service battery (par. 95).

(4) **ROAD TEST.** The preparation for limited storage includes a road test after the battery cooling system and lubrication service, to check the general condition of the vehicle. Correct any defects noted in the vehicle operation before the vehicle is stored, or note on a tag attached to the steering levers, stating the repairs needed or describing the condition present. Make a written report of these items to the officer in charge.

SHIPMENT AND LIMITED STORAGE

(5) **FUEL IN TANKS.** It is not necessary to remove fuel from the vehicle tanks for shipment within the United States, nor to label the tanks under Interstate Commerce Commission Regulations. Leave fuel in the tanks except when storing in locations where fire, ordnance, or other local regulations, require removal of all gasoline before storage.

(6) **EXTERIOR OF VEHICLE.** If time permits remove rust appearing on any part of the vehicle exterior with flint paper. Repaint painted surfaces whenever necessary to protect metal. Coat exposed polished metal surfaces susceptible to rust with medium grade preservative lubricating oil. Close firmly all hatches and other openings. Make sure paulins are in place, and firmly secured. Leave rubber floor mats, when provided, in an unrolled position on the floor, not rolled or curled up. Equipment such as pioneer tools, track tools, and fire extinguishers can remain in place on the vehicle.

(7) **INSPECTION.** Make a systematic inspection just before shipment or temporary storage to ensure all above steps have been covered and that the vehicle is ready for operation on call. Make a list of all missing or damaged items and attach it to the steering levers. Refer to Before-operation Service (par. 35).

(8) **BRAKES.** Release brakes and chock tracks.

c. **Inspections in Limited Storage.** Inspect vehicles in limited storage for condition of the battery. If water is added to the battery when freezing weather is anticipated, recharge the battery with a portable charger or remove and charge the battery. Do not attempt to charge the battery by running the engine.

224. LOADING AND BLOCKING FOR RAIL SHIPMENT.

a. **Preparation.** In addition to the preparation described in paragraph 223, when ordnance vehicles are prepared for domestic shipment take the following steps:

(1) **EXTERIOR.** Cover the vehicle with the canvas cover supplied as an accessory, or which is available for use during rail shipment.

(2) **BATTERY.** Disconnect the battery to prevent its discharge by vandalism or accident. This may be accomplished by disconnecting the positive lead, taping the end of the lead, and tying it back away from the battery.

(3) **BRAKES.** The brakes must be applied, and the transmission placed in low gear, after the vehicle has been placed in position, with clearance between car brake wheel of, at least, 6 inches (A, fig. 241).

TANK, MEDIUM, M4A3

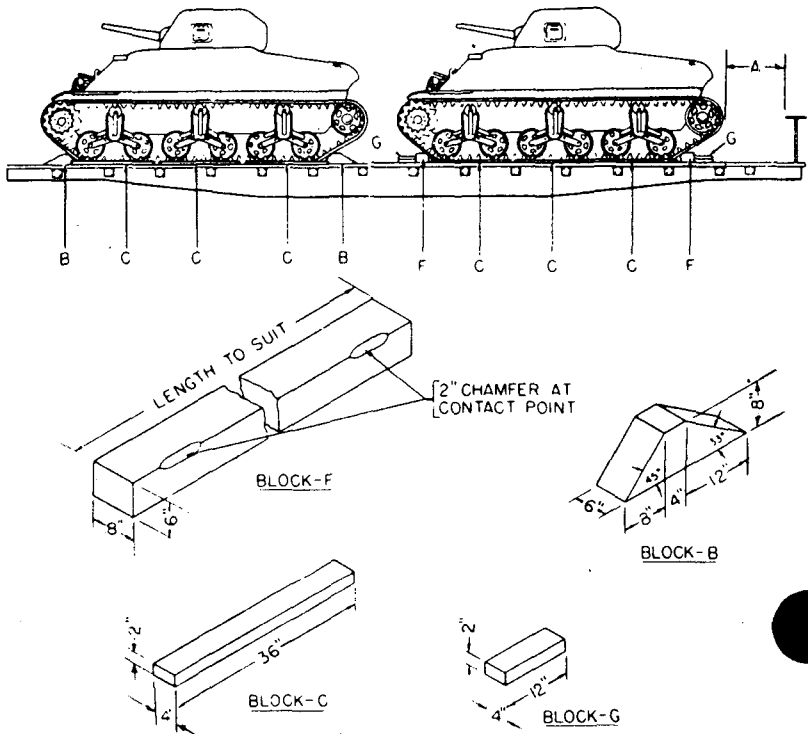

RA PD 318268

Figure 241—Blocking Requirements for Rail Shipment

Locate the vehicles on the car in such a manner as to prevent the car from carrying an unbalanced load.

(4) **MARKING CARS.** All cars containing ordnance vehicles must be placarded "DO NOT HUMP."

(5) **TYPES OF CARS.** Ordnance vehicles may be shipped on flat cars, end door box cars, side door box cars, or drop end gondola cars, whichever type is most convenient.

b. Facilities for Loading. Whenever possible, load and unload vehicles from open cars under their own power, using permanent end ramps and spanning platforms. Movement from one flat car to another along the length of the train is made possible by cross-over plates or spanning platforms. If no permanent end ramp is available, an improvised ramp can be made from railroad ties. Vehicles may be loaded in gondola cars without drop ends by using a crane

SHIPMENT AND LIMITED STORAGE

Use of shipment in side door box cars, use a dolly-type jack to warp the vehicles into position within the car.

c. **Securing Vehicles.** In securing or blocking a vehicle, three motions; lengthwise, sidewise, and bouncing must be prevented. The following are approved methods of blocking and securing these vehicles on freight cars.

(1) **METHOD ONE.** Place four blocks (B, fig. 241), one to the front and one to the rear of each track. Nail the heel of each block to the car floor with five 40-penny nails. Toenail to the car floor with two 40-penny nails that portion of each block which is under the track. Locate two blocks (C, fig. 241) on each side of the vehicle on the outside of each track. Nail each block to the car floor with three 40-penny nails. These blocks may be located on the inside of the tracks, if conditions warrant.

(2) **METHOD TWO.** Place two blocks (F, fig. 241), one to the front and one to the rear of the tracks. These blocks are to be at least as long as the over-all width of the vehicle at the car floor. Locate eight blocks (G, fig. 241) against the blocks (F, fig. 241) to the front and to the rear of each track. Nail the lower block to the floor with three 40-penny nails, and the top block to the lower block with three 40-penny nails. Locate and secure blocks (C, fig. 241) as explained in Method One.

d. **Shipping Data.**

Length (76-mm, less gun)	20 ft 7 in.
Width	8 ft 9 in.
Height over top of A.A. gun pintle stand:	
76-mm	134 ⁷ / ₈ in.
75-mm	132 ⁷ / ₈ in.
105-mm	132 ⁷ / ₈ in.
Area of floor occupied per vehicle	180 sq ft
Volume occupied per vehicle	1,980 cu ft
Shipping weight per vehicle (approximate)	69,000 lb
Bearing pressure (approximate lb per sq ft of floor space occupied by vehicle)	383

TANK, MEDIUM, M4A3

Section XLIV
REFERENCES

225. PUBLICATIONS INDEXES

The following publications indexes should be consulted frequently for latest changes to or revisions of the publications given in this list of references and for new publications relating to materiel covered in this manual:

Introduction to Ordnance Catalog (explains SNL system).....	ASF Cat. ORD-1 IOC
Ordnance publications for supply index (index to SNL's).....	ASF Cat. ORD-2 OPSI
Index to Ordnance publications (lists FM's, TM's, TC's of interest to Ordnance personnel, FSMWO's, OPSR's, BSD, S of SR's, OSSC's and OFSB's. Includes alphabetical listing of Ordnance major items with publications pertaining thereto).....	OFSB 1-1
List of publications for training (lists MR's, MTP's, T/BA's, T/A's, and FM's, TM's, TR's, SB's, WDTB's, MWO's WDLO's, numbered pamphlets, and firing tables concerning training).....	FM 21-6
List of training films, film strips and film bulletins (lists TF's, FS's, and FB's by serial number and subject).....	FM 21-7
Military training aids (lists graphic training aids, models, devices, and displays).....	FM 21-8

226. STANDARD NOMENCLATURE LISTS.

a. Vehicular.

Tank, medium, M4A3 (75-mm gun, dry).....	SNL G-104 Vol. 8
Tank, medium, M4A3 (75-mm gun, wet).....	SNL G-204
Tank, medium, M4A3 (76-mm gun, wet).....	SNL G-205
Tank, medium, M4A3 (105-mm howitzer).....	SNL G-104 Vol. 15

REFERENCES

Ammunition.

- Ammunition, blank, for pack, light, and medium field artillery ORD 11
SNL R-5
- Ammunition, fixed and semifixed, including sub-caliber, for pack, light and medium field aircraft, tank, and antitank artillery, including complete round data ORD 11
SNL R-1
- Ammunition instruction material for pack, light and medium field, aircraft, tank, and antitank artillery..... ORD 11
SNL R-6

c. Armament.

- Gun, 75-mm, M3 (Tank), mount, combination gun, M34 and M34A1 SNL C-44
- Gun, 76-mm M1A1 and M1A2 and mount, combination gun, M62 (T80) SNL C-64
- Gun, machine, cal.30, Browning M1919A4, fixed and flexible, M1919A5 fixed and M1919A6 flexible ... SNL A-6
- Gun, machine, cal.50, Browning M2, heavy barrel, flexible..... SNL A-39
- Howitzer, 105-mm, M4; and mount, combination gun, M52..... SNL C-63

d. Maintenance.

- Cleaning, preserving and lubricating materials: recoil fluids, special oils, and miscellaneous related items..... SNL K-1
- Kit, repair, instrument, M4 (for field artillery and coast artillery)..... SNL F-206
- Ordnance maintenance sets ORD 6
SNL N-21
- Tools, maintenance, for repair of automatic guns, automatic gun aircraft materiel, automatic and semiautomatic cannon and mortars—Individual items and parts SNL A-35
- Tool-sets for Ordnance Service Command, automotive shops SNL N-30

TANK, MEDIUM, M4A3

Tool-sets (common), specialists and organizational	SNL G-27 (Section 2)
Tool-sets (special), automotive and semi-automotive	SNL G-27 (Section 1)
Soldering, brazing and welding material, gases and related items	SNL K-2

e. Sighting Equipment.

Mount, telescope, M21	SNL F-197
Periscopes, telescopes for periscopes, and direct sighting telescopes for use in tanks	SNL F-235
Quadrant, gunner's, M1 (mils) (previously M1919)	SNL F-140
Stabilizers (all types)	SNL C-56

227. EXPLANATORY PUBLICATIONS.

a. Firing Tables.

An up-to-date index of firing tables is maintained in	FM 21-6
Gun, 75-mm, M2 and M3 (Tank), firing:	} FT 75-AD-5, and changes
Shell, H. E., M48;	
Shell, H. E., Mk. I;	
Shell, smoke (WP) Mk. II;	
Projectile, A.P.C., M61;	
Shot, A.P., M72;	} FT 76-A-4
Shell, fixed (smoke), B.E., M89	
Gun, 76-mm, M1A1 and M1A2, firing:	} FT 76-A-4
Shell, H. E., M42A1	
Projectile, A.P.C., M62	
Shot, A.P., M72	} FT 105-H-3, and changes*
Howitzer, 105-mm, M2, M2A1 and M4, firing:	
Shell, smoke, B. E., M84;	
Shell, H. E., M1;	

b. Fundamental Principles.

Automotive electricity	TM 10-580
Ammunition, general	TM 9-1900

*Change 5 provides corrections required when firing the M1 high-explosive rounds for the 105-mm Howitzer, M3, in the M2, M2A1 or M4 howitzers.

REFERENCES

- Auxiliary fire-control instruments (field glasses, eyeglasses, telescopes and glasses)..... TM 9-575
- Basic maintenance manual..... TM 38-250
- Driver's manual..... TM 10-460
- Driver selection and training TM 21-300
- Electrical fundamentals TM 1-455
- Field artillery and field motor ammunition OFSB 3-3
- Fuels and carburetion TM 10-550
- General instructions for recoil fluid, light and medium field artillery..... OFSB 6-6
- Instruction guide, small arms data TM 9-2200
- Military motor vehicles..... AR 850-15
- Motor vehicle inspections and preventive maintenance service..... TM 9-2810
- Precautions in handling gasoline..... AR 850-20
- Qualifications in arms and ammunition training allowances AR 775-10
- Radio fundamentals..... TM 11-455
- Range regulations for firing ammunition for training and target practice..... AR 750-10
- Small arms ammunition..... OFSB 3-5
- Small arms ammunition..... TM 9-1990
- Targets, target materials, and rifle range construction TM 9-855
- Maintenance and Repair.**
- Cleaning, preserving, lubricating and welding materials and similar items issued by the Ordnance department..... TM 9-850
- Maintenance and care of pneumatic tires and rubber treads..... TM 31-200
- Ordnance maintenance: Accessories for Ford tank engine, model GAA V-8 TM 9-1731C
- Ordnance maintenance: Auxiliary generator (Homelite HRUH-28) for medium tank M4 and modifications..... TM 9-1731K
- Ordnance maintenance: Browning machine gun, cal. .50—all types TM 9-1225

TANK, MEDIUM, M4A3

Ordinance maintenance: Carburetors (Stromberg)	TM 9-1826B
Ordinance maintenance: Electric traversing mechanism for medium tank M4 and modifications	TM 9-1731E
Ordinance maintenance: Ford tank engine, Model GAA V-8.....	TM 9-1731B
Ordinance maintenance: Hydraulic traversing mechanism (Logansport) for medium tank M4 and modifications.....	TM 9-1731E
Ordinance maintenance: Hydraulic traversing mechanism (Oilgear) for medium tank M4 and modifications.....	TM 9-1731G
Ordinance maintenance: Power train, one-piece differential case, for medium tanks M3 and M4 and related gun motor carriages.....	TM 9-1750B
Ordinance maintenance: Power-train unit, three-piece differential case, for medium tanks M3, M4, and modifications.....	TM 9-1750
Ordinance maintenance: Thompson submachine gun, cal. .45 M1928A1.....	TM 9-1215
Ordinance maintenance: Tracks and suspension, turret and hull for medium tank M4.....	TM 9-1750K
Ordinance maintenance: 75-mm tank gun materiel M2 and M3.....	TM 9-1307
Ordinance maintenance: 76-mm gun M1.....	TM 9-1308
Ordinance service in the field	FM 9-5
d. Operation of Materiel.	
2-inch mortar, M3	TM 9-293
75-mm tank guns M2 and M3 and mounts M1, M34 and M34A1.....	TM 9-307
76-mm gun materiel M1 (combat vehicles) ...	TM 9-308
105-mm howitzer M4 (mounted in combat vehicles)	TM 9-324
Browning machine gun, cal. .30, HB, M1919A4 (mounted in combat vehicles).....	FM 23-50
Browning machine gun, cal. .50, HB, M2 (mounted in combat vehicles).....	FM 23-65

REFERENCES

- Cold weather lubrication and service of artillery materiel..... OFSB 6-5
- Cold weather lubrication and service of combat vehicles and automotive materiel..... TB ORD 126
- Radio sets SCR-508, SCR-528, SCR-538..... TM 11-600
- U. S. Rifle, cal. .30, M1903..... FM 23-10

- e. Protection of Materiel.**
 - Camouflage FM 5-20
 - Chemical decontamination, materials and equipment TM 3-220
 - Decontamination of armored force vehicle..... FM 17-59
 - Defense against chemical attack FM 21-40
 - Explosives and demolitions..... FM 5-25

- f. Storage and Shipment.**
 - Ordnance storage and shipment chart, group G—Major items OSSC-G
 - Registration of motor vehicles AR 850-10
 - Rules governing the loading of mechanized and motorized army equipment, also major caliber guns, for the United States Army and Navy, on open top equipment published by Operations and Maintenance Department of Association of American Railroads.
 - Storage of motor vehicle equipment AR 850-18

TANK, MEDIUM, M4A3

INDEX

A	Page		Page
Accelerator, road test	110	Antifreeze compound	61
Accessories		Antifreeze record, road test	109
after-operation and weekly services	92	Armor	
at-halt service	90	after-operation service	94
before-operation service	85	road test	102, 105
cold-weather accessories	59		
run-in test	77	B	
Accessory drives (See Drives, accessory)		Backfires, engine	119
Accidents, driver's report, motor transportation	2	Batteries	
Adapter housings, removal	173	after-operation and weekly service	92
Adapters, carburetor (See Carburetors)		description	
Air cleaners		batteries	241
after-operation service	92	heater unit	241
at-halt service	90	master switch	247
description	213	operating instructions (master switch)	40
installation	191	precautions	379
lubrication	65	rail shipment	449
removal	189	replacement	
replacement	214	batteries	
road test	106, 114	battery switch	
run-in test	77	heater unit	247
Ammeter		road test	110
before-operation service	85	run-in test	77
does not show charge	124	storage	448
operating instructions	38	test of master switch	141
road test	98, 115	trouble shooting	122
run-in test	79	Battery charging system, radio interference suppression	362
test shunt for loose connections	146	Bearing cone, installation	
Ammunition		bearing cone	315
authorized rounds		bearing cone suspensions	327
gun M1A1	426	Bearing cups, replacement	315
gun M3	395	Bearings	
howitzer M4	443	adjustment (idler wheel)	315
data	19, 20, 21, 22	inspection (idler wheel)	315
preparation for firing		installation	
gun M1A1	428	bearings and studs	175
gun M3	397	idler wheels	335
howitzer M4	446	suspension wheels	340
Antenna		lubrication	70, 72
data	13	removal	
description	374	idler wheel	335
inspection	377	suspension wheels	40
precautions	378		

INDEX

B — Contd.

	Page		Page
Bearings—(Contd.)		removal	
replacement		control levers	300
clutch release bearing	272	cross shaft assembly	304
propeller shaft and universal joint bearing	276	parking brake	302
Belts		steering brake shoes	
after-operation and weekly services	92	double-anchor type	286
at-halt service	90	single-anchor type	281
run-in test	77	road test	99, 112
Binocular M13	14	run-in test	80
Bogie assembly		storage	449
road test	103	(See also Steering brake linkage)	
run-in test	77	Breaker point	197, 198
Bogie wheels		Breaker point gap	195
road test	101	Breather	
tire wear	159	description	186
Bomb thrower	116	lubrication	70
Bonding, radio interference suppression	360	road test	112
Bore, gun, lubrication	71	service filter element	186
sight		Breather cap	
gun M1A1	425	after-operation	92
gun M3	395	at-halt service	90
howitzer M4	443	road test	106
Brakes		run-in test	77
adjustment of steering brake		Breech mechanism	
band support screw	299	lubrication	70, 72
major adjustments		operation	
double-anchor brake	293	gun M1A1	414
single-anchor brake	298	gun M3	388
minor adjustments	290	howitzer M4	438
recentering brake band	299	Bulkhead, road test	108
description			
parking brake mechanism	302		
steering brake shoes			
double-anchor type	283		
single-anchor type	281		
during-operation service	88		
installation			
control levers	300		
cross shaft assembly	306		
parking brake	302		
steering brake shoes			
double-anchor type	287		
single-anchor type	283		
operating instructions	28		
mail shipment	449		

C

Camouflage net	
after-operation service	94
at-halt service	90
before-operation service	87
run-in test	78
Camshaft	
installation	
bearings and studs	175
camshafts	177
gear assemblies	177
housings	179
removal	171
time camshafts	177

TANK, MEDIUM, M4A3

C— Contd.	Page		Page
Carburetors		description	13, 372
description and adjustment		inspection	377
adapters	212	Compass	
carburetors	194, 208	description	241
installation		location	39
adapter	212	road test	113
adapter housings	178	Condensers, radio interference	
carburetors	180, 210	suppression	360
heating pipes	178	Cooling system	
removal		capacity of	225
adapter	212	cleaning	225
carburetor	171, 210	cold-weather operation	61
heater pipes	173	coolant service	227
road test	106, 107	description and servicing	225
Circuit breaker		draining	186
description	259	filling	193
operating instructions	42	leaks	226
replacement	260	neutralizing and flushing	226
short circuits or grounded wires	151	storage	448
test	141	trouble shooting	137
Clock		Cradle, lubrication of bearings	72
before-operation service	86	Crankcase	
road test	99	description of breather	
run-in test	79	lubrication	
Closing spring cylinder assembly,		road test	101
breach, lubrication	72	service filter element	186
Clutch		Cranking motor	
adjustments		description and replacement	
clutch	267	cranking motor	262
pedal	266, 268	cranking motor relay	263
connect throw-out clevis	190	road test	105, 110
description	266	test	129
disconnect throw-out clevis	189	Crankshaft, installation of oil seal	183
during-operation service	88	Cupola vision blocks	349
lubrication of bearing	70	Cylinder heads and gaskets	
operating instructions	32	installation	173
replacement		removal	
booster	269	cylinder heads	173
clutch	271	gaskets	170
release bearing or fork	272	road test	107
road test		Cylinders, compression test	105
clutch	99		
clutch assembly	107		
pedal	112		
run-in test	80		
trouble shooting	156		
Collector ring, road test	113		
Communications equipment			
data	10		

D

Decontaminator			
after-operation service	92		
before-operation service	87		
road test			

INDEX

D— Contd.		Page	Page	
Defroster		265	Electrical connections, engine	193
Degassers		211	Electrical system	
Differential			cold-weather operation	62
road test		156	description	241, 256
temperatures		101	replacement	
Door shutter controls, engine compartment		34	conduits	256
Doors, engine compartment			wires	257
description and installation		348	Elevating mechanism	
operation		28	road test	101, 115, 116
removal			run-in test	81
doors		348	Elevation quadrant M9	
doors and floor plate		186	gun M1A1	425
Drive cables, replacement		235	gun M3	395
Drive motor (turret traversing mechanism)		359	howitzer M4	443
Drive shafts (accessory) and universal joints			Engine	
description and replacement		277	abnormal noise	122
lubrication of housing		70	after-operation service	91, 92
drive sprocket and hub			check for water and oil leaks	194
description		300	cleaning	95
removal and installation		301	data	166
Drive sprockets			definition of terms	166
description and removal		319	description	160
installation		320	during-operation service	88
Driver's Permit and Form No. 26		87	installation	190
Driver's Report—Accident, Motor Transportation		2	location and mountings	166
Driver's Trip Ticket and Preventive Maintenance Service Record		2	lubrication system (cold weather)	59
Drives, accessory			preparation for towing	46
before-operation service		85	removal	105, 186, 190
description and replacement		231	road test	100, 109, 114, 115
road test		108	run-in test	79, 81
Driving controls, operating instructions		28	service before operation	87
Duty Roster		2	starting	
			auxiliary generator	54
			engine	42
			stopping	44
			trouble shooting	118, 119
			warm-up	79, 85
			(See also Mounts, engine)	
			Engine compartment	
			close and fasten rear door	194
			installation	
			covers	195
			doors	348
			road test	108
			(See also Doors, engine compartment)	

E

Echelons, maintenance services		
first echelon		83
second echelon		95

TANK, MEDIUM, M4A3

E— Contd.		Page		
Equipment			radio interference suppression	360
after-operation and weekly check	95		removal and cleaning of filter element	218
before-operation service	87		road test	114
data	13		run-in test	77
gun	19		Filter, oil	
road test check	116		after-operation and weekly service	92
run-in test	80		description	184
Escape hatch			lubrication	71
description	346		operation check	185
operating instructions	28		radio interference suppression	360
road test	102		removal and installation	185
Exchange Part or Unit Identification Tag	4		road test	108
Exhaust pipes			Final drive	
installation	190		cold-weather lubrication	62
removal	189, 190		description	278
replacement	224		drain housing	286
road test	108		drain oil	303
Exhaust system	208		installation	
			final drive assembly	301
			housing cover	289
			removal	
			road test	101, 102, 112
			serial number	
			temperatures	
			at-halt	89
			road test	101
			run-in test	81
			Final reduction assembly, removal and installation	301
			Fire control equipment	
			gun M1A1	417
			gun M3	392
			howitzer M4	441
			Fire extinguisher	
			after-operation service	91
			before-operation service	84
			connect	
			bracket	307
			nozzle	192
			description	55, 56
			disconnect	
			bracket	304
			nozzles	189
			operation	56
			road test	109, 117
			run-in test	
F				
Fans				
description	58, 229			
fill oil fans	193			
installation	192, 193			
operation	58			
removal	189			
replacement				
belt	229			
fan	230			
road test	107			
Fenders				
after-operation service	94			
at-halt service	90			
before-operation service	87			
installation	307			
removal	303			
replacement	345			
road test	102			
run-in test	77			
Fighting compartment, road test	111			
Filter, fuel				
after-operation service	92			
description				
auxiliary generator tank	219			
main tank	217			
drainage	218			

INDEX

F—Contd.	Page	Page
Fire extinguisher system		
conduits and cable	370	
cylinders	369	
pull cables	371, 372	
removal		
cylinders, conduits, and cable	369	
pull cables	371, 372	
Fire fighting equipment	14	
Firing mechanism, lubrication	70	
Flag set	13	
Flange nuts		
at-halt service	89	
before-operation service	86	
run-in test	77	
Flares	13	
Floor plates	193, 300	
Flywheel, timing mark data	198	
Fuel		
after-operation and weekly service	91	
at-halt service	89	
before-operation service	84	
fuel level check	210	
leaks	110	
run-in test	76	
Fuel cut-off switch	42	
Fuel gage		
before-operation service	85	
operating instructions	38	
road test	99	
run-in test	79	
Fuel lines		
connect	180, 191	
disconnect	170, 189	
road test	108, 114	
Fuel mixture, auxiliary generator	52	
Fuel system		
cold-weather operation	60	
trouble shooting	132	
Fuel tanks (See Tanks, fuel)		
Fuze setter M14	395, 425	
Fuze setter M23	442	
Fuzes	446, 447	
G		
Gages, run-in test	80	
Gear assemblies, camshaft, installation	177	
Gear cases, lubrication	71, 72	
Gear housing, turret traversing, lubrication	72	
Gear mechanism, traversing mechanism (See Traversing Mechanism, turret)		
Gears		
during-operation service	88	
oil levels	93	
Gearshift lever		
operating instructions	34	
replacement	281	
Generating system		
precautions	379	
test for interference	159	
trouble shooting	122	
(See also Generators)		
Generator regulator		
description	260	
replacement	262	
test		
Generators		
adjustment of belts	258,	
cleaning	219	
description		
auxiliary generator	367	
fuel tank	219	
generator	52	
disconnect drive pulley	303	
do not charge batteries	125	
fuel mixture	52	
lubrication	70, 72	
radio interference suppression	362, 364	
replacement		
auxiliary generator	367	
fuel tank	224	
generator	258	
road test	105, 114, 115	
(See also Generating system)		
Glass		
after-operation service	91	
before-operation service	86	
Governor		
description	212	
installation	180	
link adjustment		

TANK, MEDIUM, M4A3

G—Contd.	Page	Page
Governor—Contd.		
removal		control of gun 387
controls 170		differences among models 381
governor 171, 212		elevating or depressing 384
road test 107		inspection before firing 381
set 195		loading and firing 390
spark advance 198		operation
Grenades, hand 22		breech mechanism 388
Grouzers 335		gun 381
Guards		stabilizer 384, 388
at-halt service 90		place in
road test 102		firing position 381
Gun M1AC (See Gun M1A1, 76-mm)		traveling position 392
Gun M1A1, 76-mm		starting the stabilizer 387
adjustment of rheostats 412		(See also Guns)
ammunition 426		Guns
bore sighting 425		after-operation service 94
characteristics		data
gun 400		75-mm gun 19
sighting and fire control		cal. .30 machine gun
equipment 417		M1919A4 20
control of gun 410		cal. .50 machine gun M2 21
differences among models 403		cal. .45 submachine gun M3 22
elevating or depressing 410		2-inch mortar 22
hydraulic traverse control		hand grenades 22
handle 408		during-operation service 88
inspection before firing 403		road test 115, 116
loading and firing 415		spare parts
operation		75-mm gun 22
breech mechanism 414		cal. .30 machine gun
gun 403		M1919A4 23
stabilizer 410, 413		cal. .50 machine gun M3 24
placing in		tools 18
firing position 403		(See also under specific guns)
traveling position 416		Gun-traveling locks 349
starting the stabilizer 411		
(See also Guns)		
Gun M1A2 (See Gun M1A1, 76-mm)		
Gun M3, 75-mm		
adjustments		
bore sighting 395		
rheostats 387		
ammunition 395		
characteristics		
gun 380		
sighting and fire control		
equipment 392		

H

Hatch doors (driver's) 347, 348
Horn
after-operation service 91
before-operation service 86
description and replacement 264
road test 102
run-in test 79
trouble shooting 153
Horn button
installation of conduit 307
operating instructions 42
trouble shooting 153

INDEX

H—Contd.	Page	Page
Hose, installation	181	
Howitzer M4		
ammunition	443	
characteristics		
howitzer	430	
sighting and fire control equipment	441	
check oil level in recoil cylinder	433	
cleaning and lubrication	441	
elevating or depressing	437	
inspection before firing	433	
installation of muzzle cover	441	
loading and firing	438	
operation		
breech mechanism	438	
howitzer	432	
place in		
firing position	432	
traveling position	441	
Hub temperatures		
at halt	89	
road test	101	
run-in test	81	
(See also Drive sprocket and hub and Idler wheel and hub assembly)		
Hull		
after-operation service	94	
at-halt service	90	
before-operation service	87	
description	245	
removal of engine and exhaust pipes	190	
run-in test	78	
I		
Idler, lock		
adjustment		
horizontal spring	313	
vertical spring	332	
release	332	
Idler wheel and bracket		
assembly and installation		
horizontal spring	315	
vertical spring	335, 337	
cleaning		
horizontal spring	313	
vertical spring	335	
inoperative wheel	159	
inspection of parts		
horizontal spring	315	
vertical spring	335	
removal and disassembly		
horizontal spring	313	
vertical spring	335	
Idler wheel and hub assembly	313, 315	
Ignition system		
description and data	195	
ignition timing	198	
radio interference suppression	361	
road test	106	
trouble shooting	122	
Inspection records	4	
Instrument panels		
description and replacement	234	
disassembly and assembly	234	
panel lamps only will light	1	
test of main feed wires	1	
use of gages	4	
utility outlets	42	
(See also Light switches)		
Instruments		
after-operations service	91	
before-operation service	85	
check (engine installation)	194	
during-operation service	88	
operating instructions	38	
radio interference suppression	365	
replacement	235	
road test	98	
run-in test	79, 80	
use in vehicular operation	42	
Intake and exhaust systems	208	
Interphone control boxes		
description	375	
inspection	377	
precautions	379	
J		
Junction box		
installation		
removal		

TANK, MEDIUM, M4A3

L	Page		Page
Lamps (See Lights)		records	
Light switches, operation	39	service record	2
		work sheets	4
Lights		second echelon	95
after-operation service	91	Major Unit Assembly Replace-	
before-operation service:	86	ment Record	2
description		Manifolds	
blackout and tail lights	255	description	167
compartment lights	256	installation	
headlights	253	intake and exhaust manifolds	168
utility sockets	255	water outlet manifolds	179
replacement of lamp-unit		removal	
blackout and tail lights	255	intake and exhaust manifolds	168
compartment lights	256	water manifolds	170
headlights	254	road test	107
utility socket	256	Microphones, inspection	377
road test	113	Misfires, engine	119
run-in test	80	Mortar, 2-inch, data	22
timing light		Mount, gun	
connect	199	disconnect spring bracket	304
use of	200	lubrication	71
trouble shooting	141	road test	115
Linkage (See Steering brake		Mounting bases, radio sets	
linkage)		description	373
Locks, gun-traveling	349	inspection	377
Lubrication	64	Mounds, engine	
		connect	190
		description	168
		disconnect	189
		installation and removal	168, 170
		road test	108
		Muffler	368, 369
		Muzzle cover, howitzer	441
		O	
		Odometer, road test	99
		Oil	
		after-operation service	91
		at-halt service	89
		before-operation service	84
		check for leaks	194
		consumption	100, 119
		draining	186
		leaks	110
		low or no pressure	119
		oil levels	93

M

MWO's (Modification Work			
Orders)	117		
Magneto			
check spark advance	200		
data	167, 195		
description and replacement	196		
installation	205		
lock in place	206		
lubrication	72		
road test	106, 114		
timing			
major adjustments	203		
minor adjustments	202		
Maintenance services			
after operation and weekly	90		
at halt	89		
before operation	84		
during operation	87		
first echelon	83		

INDEX

O—Contd.	Page	Page
Oil—Contd.		
oil pressure signals		
engine boil	38	
high water temperature	79	
low oil pressure	38, 79	
run-in test	76	
spare supply	117	
Oil cooler		
connect tubes	307	
description	278	
disconnect tubes	304	
removal and installation	302	
road test	108	
Oil filler pipe		
installation	193	
removal	188	
Oil filter (See Filter, oil)		
Oil level gage		
before-operation service	86	
operating instructions	39	
replacement	240	
road test	99	
run-in test	79	
Oil pan		
description and removal	181	
drain oil	186	
installation	183	
Oil pressure gage (See Pressure gage, oil)		
Oil reservoir	356	
Oil retainers	340	
Oil seal, crankshaft	183	
Oil temperature gage (See Temperature gage, oil)		
Oilcan points	71	
Operation		
auxiliary equipment	52	
under ordinary conditions	42	
under unusual conditions	58, 63	
P		
Panel set	14	
Periscopes		
description and operation		
general discussion	58	
periscope M4A1	394, 422, 442	
periscope M10C	394	
periscope M10D	442	
periscope M10G	425	
replacement		
periscopes	347	
stowage rack	304	
road test	111	
Pintle, road test	102	
Pintle hook	348	
Power train assembly		
description	278	
installation	306	
removal	303	
trouble shooting	156	
Pressure filler cap, inspection	137	
Pressure gage, oil		
before-operation service	85	
operation	38	
replacement	240	
road test	98	
run-in test	79	
Primer		
before-operation service	85	
operation	32	
road test	107	
run-in test	79	
Primer lines		
connect	191	
disconnect	189	
Propeller shaft		
after-operation and weekly services	93	
road test	112	
trouble shooting	156	
(See also Propeller shafts and universal joints)		
Propeller shafts and universal joints		
description	275	
removals	275, 276	
run-in test	78	
Publications	81, 117	
Pump, fuel		
description and replacement	217	
installation	180	
removal	170	
road test	108	
vacuum and pressure tests	101	
Pump, oil	183, 184	
Pump, priming		
description and replacement		

TANK, MEDIUM, M4A3

P—Contd.		Page	Page	
Pump, priming—Contd.			Reports	81, 117
disconnect	304	Rheostats, adjustment		
installation of bracket	307	gun M1A1	412	
Pump, traverse	355	gun M3	387	
Pump, water		Road test	98	
description and lubrication	229	Rubbing plate, replacement	345	
inspection	137	Run-in test	78, 80	
installation	193, 229	Running gear	88	
removal	188, 229			
road test	107			
Push rods				S
check clearance	171	Seals, idler wheel	315	
release	175	Seats		
		removal and installation	300	
		road test	103	
R		Selector switch	38	
Radiator		Shielding, radio interference sup- pression	360	
description	227	Shields, sand		
inspection	138	after-operation service	94	
installation		at-halt service	90	
connections	193	before-operation service	87	
radiator	228	removal	303	
removal		replacement	345	
connections	189	run-in test	77	
radiator	227	Shift lever (turret)	51	
road test	105, 109	Shipping	449, 451	
(See also Tank, radiator expan- sion)		Shock absorbers		
Radio		description	308, 320	
description		filling absorber on vehicle	322	
master switch	252	Shroud assemblies		
terminal boxes	365	installation	192	
operation of switch	41	removal	189	
precautions in use of	378	replacement	230	
radio bonding	113	road test	107	
Radio interference suppression		Sighting equipment		
description and operation	359	characteristics		
trouble shooting	159	gun M1A1	417	
Ratjons	14	gun M3	392	
Recoil cylinder, check oil level		howitzer M4	441	
gun M1A1	403	data	14	
g M3	381	Siren		
howitzer M4	433	description and replacement	264	
Recoil mechanism, road test	116	road test	99	
Records	2, 72	trouble shooting	153	
Regulators		Siren button	42	
radio interference suppression	364	Slip joints, lubrication	70	
road test	111	Spare parts	18, 22	

INDEX

S—Contd.	Page		
Spark plugs		Support rollers	
data	196	assembly and installation	
description	206	dual support rollers	316
installation		single support rollers	319
flexible conduit	208	inoperative rollers	159
spark plugs	180	removal and disassembly	
wires	207	dual support rollers	316
removal		single support rollers	319
flexible conduit	208	road test	101
spark plugs	171	Suspension assembly	
wires	207	after-operation and weekly	
road test	105, 114	services	93
Speedometer		assembly	
connect cables	307	suspension assembly	327
disconnect cables	303	suspension wheels	340
operating instructions	38	at-halt service	89
replacement of drive cable	235	before-operation service	86
road test	99	description	308, 322
Spot-check Inspection Report for		data	308
All Motor Vehicles	4	disassembly	
Springs		hub	325
after-operation and weekly		suspension assembly	324
services	93	inspection and repair of parts	
at-halt service	89	installation	
before-operation service	86	arms and bracket	343
Sprockets, road test	104	suspension assembly	343
Stabilizer		suspension wheels	322, 340
operation		removal	
gun M1A1	410, 413	arms and hub assembly	324
gun M3	384, 388	bracket	325
road test	116	suspension assembly	343
starting		suspension wheels	322
gun M1A1	411	run-in test	78
gun M3	387	trouble shooting	159
Starting system			
operation of switch	41	T	
radio interference suppression	362	Tachometer	
trouble shooting	129	before-operation service	85
Steering brake (See Brakes)		connect cables	307
Steering brake linkage		disconnect cables	303
after-operation service	93	operating instructions	38
at-halt service	89	replacement of drive cable	235
before-operation service	86	road test	99
connect	307	run-in test	79
disconnect	304	Tachometer drive unit	
run-in test	78	installation	181
Steering levers	28	removal	
Storage	448	Tail pipe	368

TANK, MEDIUM, M4A3

T—Contd.		Page			Page
Tank			Temperature gage, water		234
backing and steering		44	Thermostat		231
cleaning		95	Throttle		
communications data		10	adjustment		
description		4	controls		214
differences among models		4, 9	hand throttle		216
lubrication		62, 64	linkage		194
performance and capacities		10	connect rod		191
setting in motion		43	description		
starting		43	controls		214
stopping		44	foot throttle		216
towing		44	hand throttle		214
trouble shooting		118	disconnect		
vehicle specifications		9	hand throttle		304
Tank, expansion			rod		189
description		232	installation		
drainage		233	foot throttle		216
installation		181, 193, 233	hand throttle		216, 307
removal		171, 188, 232	rod assembly		180
Tank, fuel			operation of controls		31
description and drainage		220	removal		
replacement			controls		170
auxiliary generator tank		224	throttles		216
horizontal tanks		221, 222	synchronization		111
vertical tanks		223	Timing adjustment		202, 203
road test		105, 108, 114	Timing light		
Tarpaulin			connect		199
after-operation service		94	use of		200
at-halt service		90	Tires		104
before-operation service		87	Tools		
run-in test		78	after-operation and weekly		
Telescope M38A2		394	check		95
Telescope M47A2		422	before-operation check		87
Telescope M70F		392	gun tools		18
Telescope M71D		419	road test check		116
Telescope M72D		441	run-in test		80
Telescope M77C		442	special tools		25
Telescope mount M56		441	vehicle tools		11
Telescope mount M57		419	Towing connections		
Temperature gage, engine			after-operation service		94
before-operation service		85	at-halt service		90
operating instructions		38	before-operation service		87
road test		98	road test		102
run-in test		79	Towing the vehicle		44
Temperature gage, oil			Tracks		
before-operation service		86	adjustment of tension		
operating instructions		39	horizontal spring		311
road test		99	vertical spring		332
run-in test		79			

INDEX

T—Contd.		Page
Tracks—Contd.		
after-operation and weekly services		93
at-halt service		89
before-operation service		86
connect shoes		311
description and data		308, 310
removal and installation		
dead track block		330, 332
horizontal spring		310
supporting roller and bracket		337, 340
vertical spring		330
road test		102
run-in test		77
space blocks		117
tension		81, 101, 104
trouble shooting		159
Transmission		
connect oil tubes		307
description		278
differential lubrication		62
disconnect oil tubes		304
drain oil		303
during-operation service		88
road test		100, 108, 112, 156
run-in test		80
temperatures		
at-halt		89
road test		101
run-in test		81
Traversing mechanism, turret		
adjustments		356
cleaning		355, 357
description		
drive motor		359
oil reservoir		356
traverse motor and gear box		
adapter		353
traverse pump		355
fill with oil		354, 356
lubrication		353, 355
operation of lever		51
radio interference suppression		365
replacement		
drive motor		359
gear mechanism and manual drive		350
oil reservoir		358
traverse motor and gear box		
adapter		353, 354
traverse pump		356
road test		101, 115, 116
run-in test		81
trouble shooting		154
Trouble shooting		
Turret		
after-operation service		94
controls		46
description		348
lubrication		72
operation		
general discussion		51
gun M1A1		404, 408
gun M3		382, 384
howitzer M4		437
road test		105, 111
trouble shooting		157
Turret locks		
		46
U		
Unit identification tag		
Universal joints		
connect		190
disconnect		189, 303
lubrication		70
(See also Propeller shafts and universal joints and Drive shafts (accessory) and universal joints)		
Unsatisfactory Equipment Record		
		4
V		
Valves		
cleaning		
oil reservoir		357
traverse pump		355
operation of fuel shut-off valves		32
Ventilating fans (See Fans)		
Ventilators, road test		
		106
Vents		
after-operation and weekly services		93
at-halt service		89
run-in test		

TANK, MEDIUM, M4A3

V—Contd.

	Page		Page
Vision devices		run-in test	76
after-operation service	94	Wet stowage	345
description	346	Wheels	
run-in test	78	at-halt service	89
Voltmeter		before-operation service	86
after-operation and weekly		road test	104
services	92	Windshield	
before-operation service	86	description	58
road test	99	road test	99
run-in test	79	Windshield wipers	
Volute springs		after-operation service	91
data	308	before-operation service	86
description		description and replacement	264
horizontal spring	308	road test	99
vertical spring	328	run-in test	79
replacement		Wiring system	
springs	324, 343	after-operation and weekly	
suspension assembly	343	services	92
road test	103	installation	
run-in test	78	conduit clamps	306
spring breakage	159	spark plugs	207
		wiring	257
		radio interference suppression	365
		removal	
		conduit clamps	304
		spark plugs	207
		wires	171
		wiring	257
		road test	106, 113
		run-in test	79
		trouble shooting	118

W

Water pump (See Pump, water)			
Water supply			
after-operation service	91		
at-halt service	89		
before-operation service	84		
leaks	110, 194		